

Technical Information

Dosimass

Coriolis flowmeter

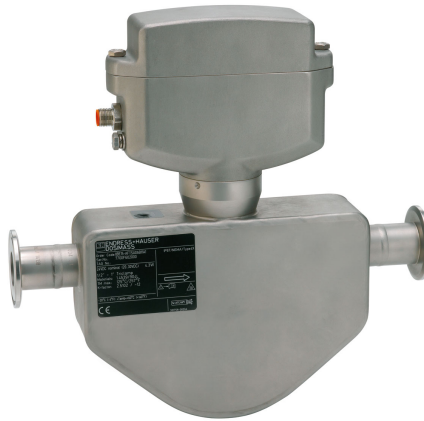

The compact sensor with an ultra-compact transmitter

Application

- Measuring principle operates independently of physical fluid properties such as viscosity or density
- Measurement of liquids in continuous process control and in batching applications

Device properties

- Nominal diameter: DN 8 to 25 ($\frac{3}{8}$ to 1")
- Many hygienic process connections, 3A-compliant
- Sensor can be cleaned/sterilized in place (CIP/SIP)
- Robust, ultra-compact transmitter housing
- Pulse/frequency/switch output, Modbus RS485
- Excellent and easy-to-clean transmitter

Your benefits

- High process safety – high measuring accuracy for different media in shortest filling time
- Fewer process measuring points – multivariable measurement (flow, density, temperature)
- Space-saving installation – no in/outlet run needs
- Versatile and time-saving wiring – plug connector
- Fast commissioning – pre-configured devices
- Automatic recovery of data for servicing







Table of contents

Document information	3	Process	22
Symbols used	3	Medium temperature range	22
Function and system design	4	Medium pressure range (nominal pressure)	23
Measuring principle	4	Density	23
Measuring system	4	Pressure-temperature ratings	23
Equipment architecture	5	Secondary containment pressure rating	24
Safety	6	Flow limit	24
Input	7	Pressure loss	24
Measured variable	7	Heating	24
Measuring range	7	Vibrations	24
Operable flow range	7	Mechanical construction	25
Input signal	7	Dimensions in SI units	25
Output	8	Dimensions in US units	29
Output signal	8	Weight	32
Signal on alarm	9	Materials	32
Low flow cut off	9	Process connections	33
Galvanic isolation	9	Operability	33
Protocol-specific data	10	Local operation	33
Power supply	10	Remote operation	33
Terminal assignment	10	Certificates and approvals	34
Pin assignment, device plug	11	CE mark	34
Supply voltage	14	C-Tick symbol	34
Power consumption	14	Ex approval	34
Current consumption	14	Hygienic compatibility	34
Power supply failure	14	Pressure Equipment Directive	35
Electrical connection	14	Other standards and guidelines	35
Potential equalization	15	Ordering information	35
Cable specification	15	Accessories	35
Performance characteristics	16	Communication-specific accessories	35
Reference operating conditions	16	Service-specific accessories	36
Maximum measured error	16	Supplementary documentation	37
Repeatability	17	Standard documentation	37
Response time	17	Supplementary device-dependent documentation	37
Influence of ambient temperature	17	Registered trademarks	37
Influence of medium temperature	17		
Influence of medium pressure	17		
Installation	17		
Mounting location	18		
Orientation	18		
Inlet and outlet runs	20		
Special mounting instructions	20		
Environment	22		
Ambient temperature range	22		
Storage temperature	22		
Degree of protection	22		
Shock resistance	22		
Vibration resistance	22		
Interior cleaning	22		
Electromagnetic compatibility (EMC)	22		









Document information

Symbols used





Electrical symbols

Symbol	Meaning
	Direct current
	Alternating current
	Direct current and alternating current
	Ground connection A grounded terminal which, as far as the operator is concerned, is grounded via a grounding system.
	Protective ground connection A terminal which must be connected to ground prior to establishing any other connections.
	Equipotential connection A connection that has to be connected to the plant grounding system: This may be a potential equalization line or a star grounding system depending on national or company codes of practice.

Symbols for certain types of information

Symbol	Meaning
	Permitted Procedures, processes or actions that are permitted.
	Preferred Procedures, processes or actions that are preferred.
	Forbidden Procedures, processes or actions that are forbidden.
	Tip Indicates additional information.
	Reference to documentation
	Reference to page
	Reference to graphic
	Visual inspection

Symbols in graphics

Symbol	Meaning
1, 2, 3,...	Item numbers
	Series of steps
A, B, C, ...	Views
A-A, B-B, C-C, ...	Sections
	Hazardous area
	Safe area (non-hazardous area)
	Flow direction

Function and system design

Measuring principle

The measuring principle is based on the controlled generation of Coriolis forces. These forces are always present in a system when both translational and rotational movements are superimposed.

$$F_c = 2 \cdot \Delta m (v \cdot \omega)$$

F_c = Coriolis force

Δm = moving mass

ω = rotational velocity

v = radial velocity in rotating or oscillating system

The amplitude of the Coriolis force depends on the moving mass Δm , its velocity v in the system and thus on the mass flow. Instead of a constant rotational velocity ω , the sensor uses oscillation.

In the sensor, two parallel measuring tubes containing flowing fluid oscillate in antiphase, acting like a tuning fork. The Coriolis forces produced at the measuring tubes cause a phase shift in the tube oscillations (see illustration):

- At zero flow (when the fluid is at a standstill) the two tubes oscillate in phase (1).
- Mass flow causes deceleration of the oscillation at the inlet of the tubes (2) and acceleration at the outlet (3).

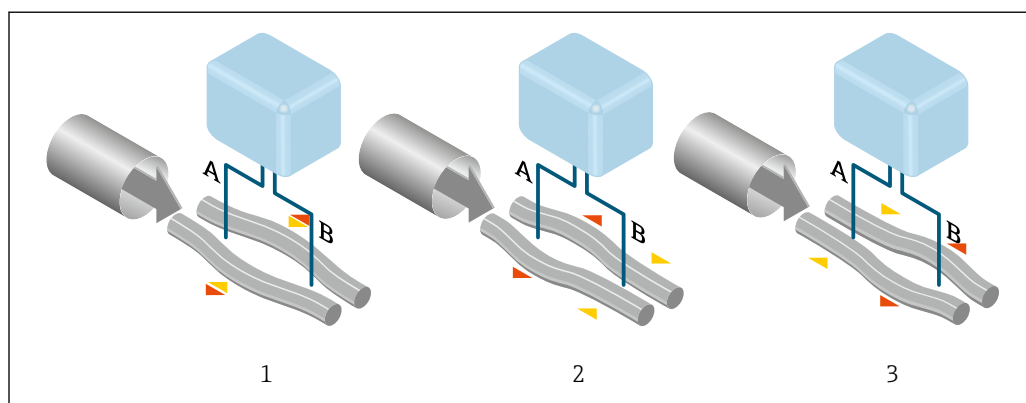

The phase difference (A-B) increases with increasing mass flow. Electrodynamic sensors register the tube oscillations at the inlet and outlet. System balance is ensured by the antiphase oscillation of the two measuring tubes. The measuring principle operates independently of temperature, pressure, viscosity, conductivity and flow profile.

Density measurement

The measuring tube is continuously excited at its resonance frequency. A change in the mass and thus the density of the oscillating system (comprising measuring tube and fluid) results in a corresponding, automatic adjustment in the oscillation frequency. Resonance frequency is thus a function of medium density. The microprocessor utilizes this relationship to obtain a density signal.

Temperature measurement

The temperature of the measuring tube is determined in order to calculate the compensation factor due to temperature effects. This signal corresponds to the process temperature and is also available as an output signal.

Measuring system

The device consists of a transmitter and a sensor.

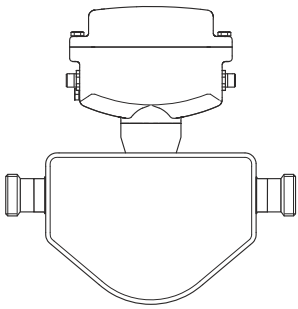

The device is available as a compact version:

The transmitter and sensor form a mechanical unit.

<p>Dosimass</p>  <p style="text-align: right; font-size: small;">A0023382</p>	<p>Transmitter</p> <ul style="list-style-type: none"> ▪ Materials: <ul style="list-style-type: none"> - Transmitter housing: stainless steel 1.4308 (304) - Housing seal: EPDM ▪ Configuration: <ul style="list-style-type: none"> Via operating tools (e.g. FieldCare) <p>Sensor</p> <ul style="list-style-type: none"> ▪ Range of nominal diameter: DN 8 (3/8"), 15 (1/2"), 25 (1") ▪ Materials: <ul style="list-style-type: none"> - Sensor housing: stainless steel 1.4301 (304) - Measuring tube: stainless steel 1.4539 (904L) - Process connections: stainless steel 1.4404 (316/316L) and 1.4435 (316L)
---	--

Equipment architecture

Device version: Two pulse/frequency/switch outputs

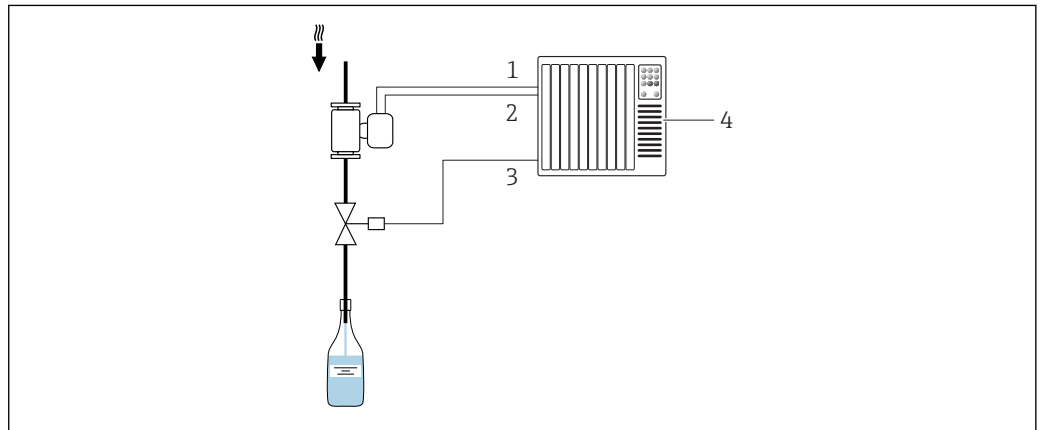

 The device version has two pulse/frequency/switch outputs →  10.



 1 Options for integration into a system for batching processes

- 1 Pulse/frequency/current output 1
- 2 Pulse/frequency/current output 2
- 3 Control of valve (by automation system)
- 4 Control system (e.g. PLC)

Device version: Modbus RS485, one or two switch outputs (Batch) and one status input

 Device versions with MODBUS RS485 have one or two switch outputs for valve control for the regulation of batching processes →  10.

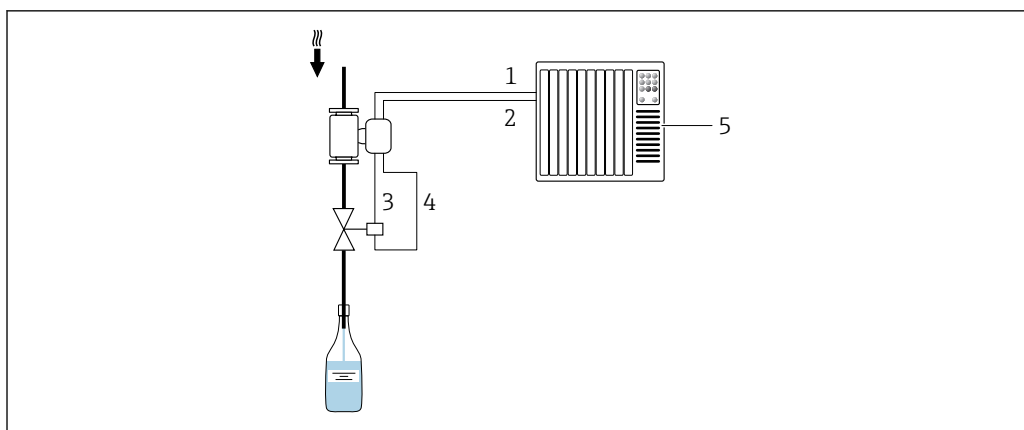

A0026621

2 Options for integration into a system for batching processes

- 1 MODBUS RS485: Measured value (to the automation system)
- 2 Status input: Control of batching process (by the automation system)
- 3 Switch output 1 (batch): valve control, level 1
- 4 Switch output 2 (batch): valve control, level 2
- 5 Control system (e.g. PLC)

Integrated batching functions

The following parameters can be used to configure and monitor batching processes.

Configuration

- Measured variable: mass or volume flow
- Unit
- Batch quantity
- Fixed compensation quantity
- Select batch profile
- Drip correction mode: Off, low flow cut off or fixed time
- Measuring time drip quantity
- Filter depth drip median (3, 5 or 7)
- Average drip correction quantity
- Batch levels: One-level, two-level or one-level and blow out
- Start and stop level 2
- Blow out delay and duration
- Maximum batch time
- Maximum flow
- Disable time pressure shock suppression

Display

- Total amount measured from last batching process (incl. drip quantity)
- Duration of last batching process (incl. measurement of drip quantity)
- Switch-off time: From time of switch-off to when measurement of the drip quantity is complete
- Current drip correction quantity (drip correction quantity for next batching process)
- Sum of all batching processes measured
- Number of batching processes



The batching process (start batch, stop batch etc.) is controlled by the automation system via the status input or the Modbus RS485 .

Safety

IT security

We only provide a warranty if the device is installed and used as described in the Operating Instructions. The device is equipped with security mechanisms to protect it against any inadvertent changes to the device settings.



IT security measures in line with operators' security standards and designed to provide additional protection for the device and device data transfer must be implemented by the operators themselves.

Input

Measured variable	Direct measured variables
	<ul style="list-style-type: none"> ■ Mass flow ■ Density ■ Temperature
	Calculated measured variables
	Volume flow

Measuring range	<i>Flow values in SI units</i>	
	DN [mm]	Measuring range full scale values $\dot{m}_{\min(F)}$ to $\dot{m}_{\max(F)}$ [kg/h]
	8	0 to 2 000
	15	0 to 6 500
	25	0 to 18 000

	<i>Flow values in US units</i>	
DN [in]	Measuring range full scale values $\dot{m}_{\min(F)}$ to $\dot{m}_{\max(F)}$ [lb/min]	
$\frac{3}{8}$	0 to 73.50	
$\frac{1}{2}$	0 to 238.9	
1	0 to 661.5	

 To calculate the measuring range, use the *Applicator* product selection tool →  36

Recommended measuring range

"Flow limit" section →  24

Operable flow range	Over 1000 : 1. Flow rates above the preset full scale value are not overridden by the electronics unit, with the result that the totalizer values are registered correctly.
----------------------------	--

Input signal	 Available only for device versions using the Modbus RS485 communication method →  10.
---------------------	--

Status input

The batching process is controlled by the automation system via the device's status input.

Maximum input values	<ul style="list-style-type: none"> ■ DC 30 V ■ 6 mA
Response time	Adjustable: 10 to 200 ms
Input signal level	<ul style="list-style-type: none"> ■ Low level: 0 to 1.5 V ■ High level: 3 to 30 V
Assignable functions	<ul style="list-style-type: none"> ■ Off ■ Start batching process ■ Start and stop batching process ■ Reset totalizers 1-3 separately ■ Reset all totalizers ■ Flow override

Output

Output signal

Pulse/frequency/switch output

Function	Can be set to: <ul style="list-style-type: none"> ▪ Pulse Quantity-proportional pulse with pulse width to be configured. ▪ Automatic pulse Quantity-proportional pulse with on/off ratio of 1:1 ▪ Frequency Flow-proportional frequency output with on/off ratio of 1:1 ▪ Switch Contact for displaying a status
Channel 2	Redundant output of pulse output: 0°, 90° or 180°
Version	Passive, open emitter
Maximum input values	<ul style="list-style-type: none"> ▪ DC 30 V ▪ 25 mA
Voltage drop	At 25 mA: ≤ DC 2 V
Pulse output	
Pulse width	Adjustable: 0.05 to 3.75 ms
Maximum pulse rate	10 000 Impulse/s
Pulse value	Adjustable
Assignable measured variables	<ul style="list-style-type: none"> ▪ Mass flow ▪ Volume flow
Frequency output	
Output frequency	Adjustable: 0 to 10 000 Hz
Damping	Adjustable: 0 to 999.9 s
Pulse/pause ratio	1:1
Assignable measured variables	<ul style="list-style-type: none"> ▪ Mass flow ▪ Volume flow ▪ Density ▪ Temperature
Switch output	
Switching behavior	Binary, conductive or non-conductive
Number of switching cycles	Unlimited
Assignable functions	<ul style="list-style-type: none"> ▪ Off ▪ On ▪ Diagnostic behavior <ul style="list-style-type: none"> - Alarm - Alarm and warning - Warning ▪ Limit value <ul style="list-style-type: none"> - Mass flow - Volume flow - Density - Temperature ▪ Flow direction monitoring ▪ Status <ul style="list-style-type: none"> - Partially filled pipe detection - Low flow cut off

Modbus RS485

Physical interface	In accordance with EIA/TIA-485-A standard
---------------------------	---

Switch output (batch: valve control)

-  Only available for device version with Modbus RS485 → 10.
- Depending on the device version, the device has one or two switch outputs.

Switch output	
Version	Active, open emitter
Maximum input values	<ul style="list-style-type: none"> ▪ DC 30 V ▪ 500 mA
Switching behavior	Binary, conductive or non-conductive
Number of switching cycles	Unlimited
Assignable functions	<ul style="list-style-type: none"> ▪ Open ▪ Closed ▪ Batching

Signal on alarm

Depending on the interface, failure information is displayed as follows:

Pulse/frequency/switch output

Pulse output

Failure mode	Choose from: <ul style="list-style-type: none"> ▪ Actual value ▪ No pulses
--------------	--

Frequency output

Failure mode	Choose from: <ul style="list-style-type: none"> ▪ Actual value ▪ 0 Hz ▪ Defined value: 0 to 10 000 Hz
--------------	--

Switch output

Failure mode	Choose from: <ul style="list-style-type: none"> ▪ Current status ▪ Open ▪ Closed
--------------	---

Modbus RS485

Failure mode	Choose from: <ul style="list-style-type: none"> ▪ NaN value instead of current value ▪ Last valid value
--------------	---

Low flow cut off



The switch points for low flow cut off are user-selectable.

Galvanic isolation

- Device version: 2 pulse/frequency/switch outputs
Order code for "Output, input", option 3:
 - Pulse/frequency/switch outputs galvanically isolated from supply potential.
 - Pulse/frequency/switch outputs not galvanically isolated from each other.
- Device version: Modbus RS485, 1 switch output (batch), 1 status input
(Order code for "Output, input": option 4)
Switch outputs (batch) and status input on supply potential
- Device version: Modbus RS485, 2 switch outputs (batch), 1 status input
(Order code for "Output, input", option 5:)
– Switch outputs (batch) on supply potential.
– Status input, galvanically isolated.

Protocol-specific data

Modbus RS485



Protocol	Modbus Applications Protocol Specification V1.1
Device type	Slave
Slave address range	1 to 247
Broadcast address range	0
Function codes	<ul style="list-style-type: none"> ▪ 03: Read holding register ▪ 04: Read input register ▪ 06: Write single registers ▪ 08: Diagnostics ▪ 16: Write multiple registers ▪ 23: Read/write multiple registers ▪ 43: Read device identification
Broadcast messages	Supported by the following function codes: <ul style="list-style-type: none"> ▪ 06: Write single registers ▪ 16: Write multiple registers ▪ 23: Read/write multiple registers
Supported baud rate	<ul style="list-style-type: none"> ▪ 1 200 BAUD ▪ 2 400 BAUD ▪ 4 800 BAUD ▪ 9 600 BAUD ▪ 19 200 BAUD ▪ 38 400 BAUD ▪ 57 600 BAUD ▪ 115 200 BAUD
Data transfer mode	<ul style="list-style-type: none"> ▪ ASCII ▪ RTU
Data access	Each device parameter can be accessed via Modbus RS485.  For Modbus register information →  37

Power supply

Terminal assignment

Connection is solely by means of device plug:

There are different device versions available:

Order code for "Output, input":	Device plug
Option 3: 2 pulse/frequency/switch outputs	→  11
Option 4: Modbus RS485, 1 switch output (batch), 1 status input	→  12
Option 5: Modbus RS485, 2 switch outputs (batch), 1 status input	→  13

Pin assignment, device plug

Device version: 2 pulse/frequency/switch outputs

Order code for "Output, input", option 3:
 2 Pulse/frequency/switch output

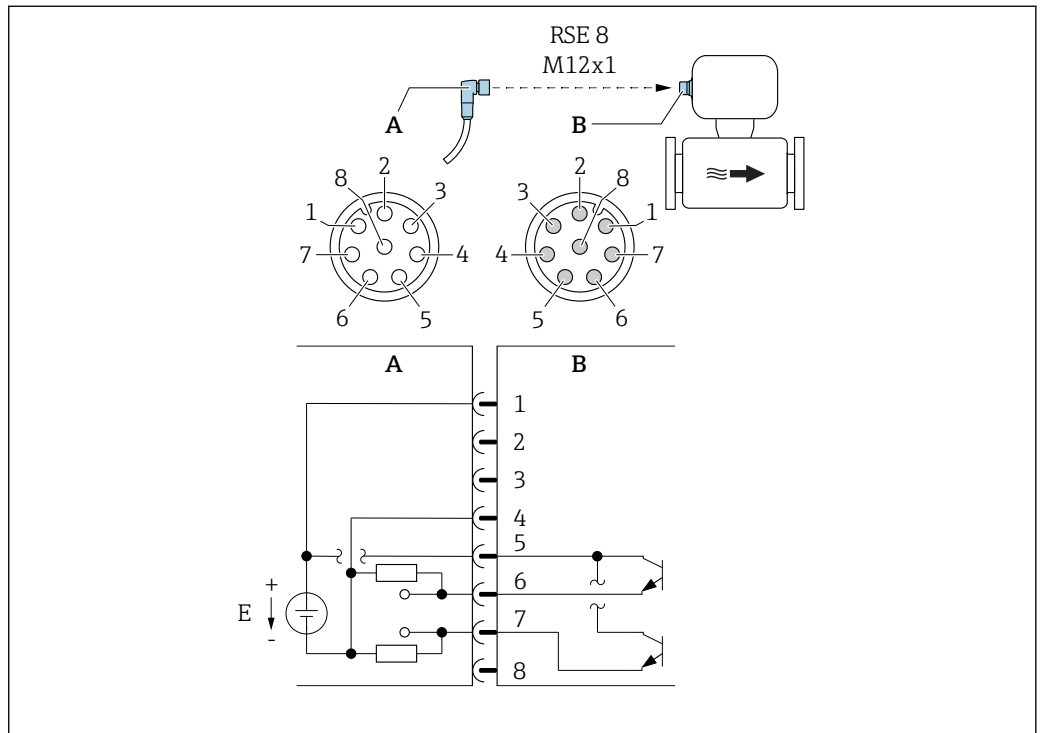

A0032569

3 Connection to device

- A Coupling: Supply voltage, pulse/freq./switch output
- B Connector: Supply voltage, pulse/freq./switch output
- E PELV or SELV power supply
- 1 to Pin assignment
- 8

Pin assignment

Connection: Coupling (A) – Connector (B)		
Pin	Assignment	
1	L+	Supply voltage
2	+	Service interface RX
3	+	Service interface TX
4	L-	Supply voltage
5	+	Pulse/frequency/switch output
6	-	Pulse/frequency/switch output 1
7	-	Pulse/frequency/switch output 2
8	-	Service interface GND

i Observe cable specifications → 15.

Device version: Modbus RS485, status output and status input

Order code for "Output, input", option 4:

- Modbus RS485
- 1 switch output (batch)
- 1 status input

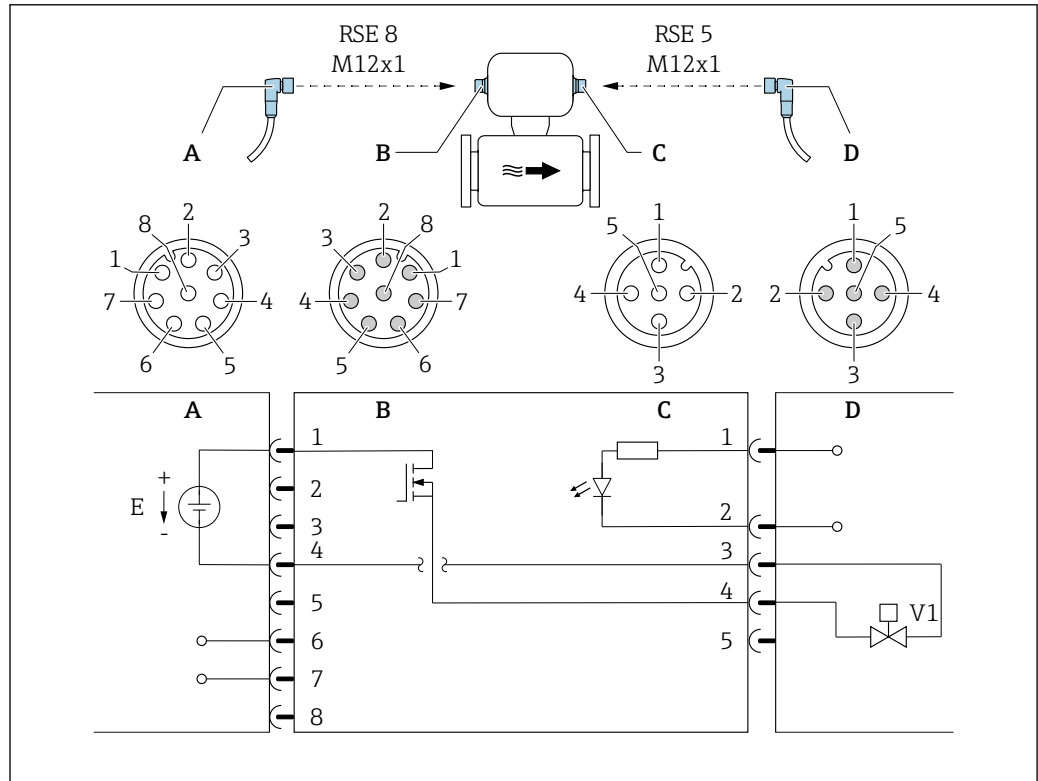

A0032570

4 Connection to device

- A Coupling: Supply voltage, Modbus RS485
- B Connector: Supply voltage, Modbus RS485
- C Coupling: Switch output (batch), status input
- D Connector: Switch output (batch), status input
- E PELV or SELV power supply
- V1 Valve 1 (batch)
- 1 to Pin assignment
- 8

Pin assignment

Connection: Coupling (A) – Connector (B)			Connection: Coupling (C) – Connector (D)		
Pin	Assignment		Pin	Assignment	
1	L+	Supply voltage	1	+	Status input
2	+	Service interface RX	2	-	Status input
3	+	Service interface TX	3	-	Switch output (batch)
4	L-	Supply voltage	4	+	Switch output (batch)
5	Not assigned		5	Not assigned	
6	A	Modbus RS485			
7	B	Modbus RS485			
8	-	Service interface GND			

Observe cable specifications → 15.

Device version: Modbus RS485 , 2 status outputs and status input

Order code for "Output, input", option 5:

- Modbus RS485
- 2 switch outputs (batch)
- 1 status input

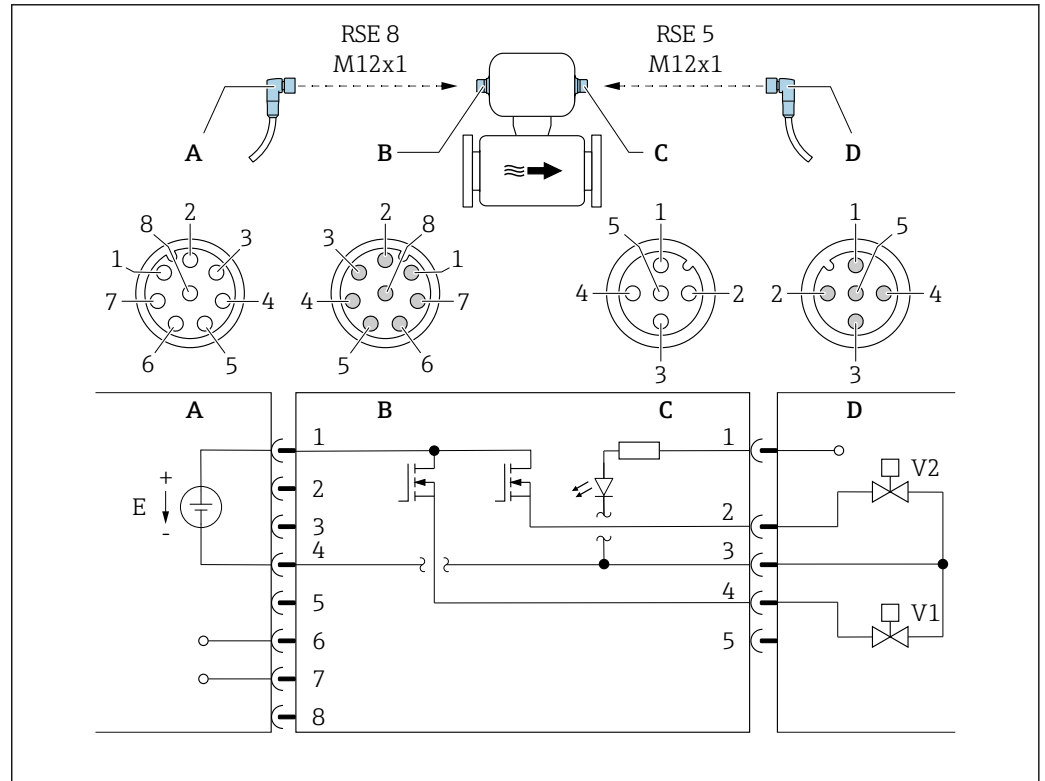

A0032571



5 Connection to device

- A Coupling: Supply voltage, Modbus RS485
- B Connector: Supply voltage, Modbus RS485
- C Coupling: Switch outputs (batch), status input
- D Connector: Switch outputs (batch), status input
- E PELV or SELV power supply
- V1 Valve (batch), level 1
- V2 Valve (batch), level 2
- 1 to Pin assignment
- 8

Pin assignment

Connection: Coupling (A) – Connector (B)			Connection: Coupling (C) – Connector (D)		
Pin	Assignment		Pin	Assignment	
1	L+	Supply voltage	1	+	Status input
2	+	Service interface RX	2	+	Switch output (batch) 2
3	+	Service interface TX	3	-	Switch outputs, status input
4	L-	Supply voltage	4	+	Switch output (batch) 1
5	Not assigned		5	Not assigned	
6	A	Modbus RS485			

Connection: Coupling (A) – Connector (B)			Connection: Coupling (C) – Connector (D)	
Pin	Assignment		Pin	Assignment
7	B	Modbus RS485		
8	–	Service interface GND		

 Observe cable specifications →  15.

Supply voltage DC 24 V (nominal voltage: DC 20 to 30 V)

-  The power unit must be tested to ensure that it meets safety requirements (e.g. PELV, SELV).
- The supply voltage must not exceed a maximum short-circuit current of 50 A.

Power consumption 3.5 W

Current consumption

Order code for "Output, input":	Maximum Current consumption
Option 3: 2 pulse/frequency/switch outputs	175 mA
Option 4: Modbus RS485, 1 switch output (batch), 1 status input	175 mA + 500 mA ¹⁾
Option 5: Modbus RS485, 2 switch outputs (batch), 1 status input	175 mA + 1000 mA ¹⁾

1) Additional 500 mA per switch output (batch) used.

 Switch-on current: max. 1 A (< 6 ms)

Power supply failure

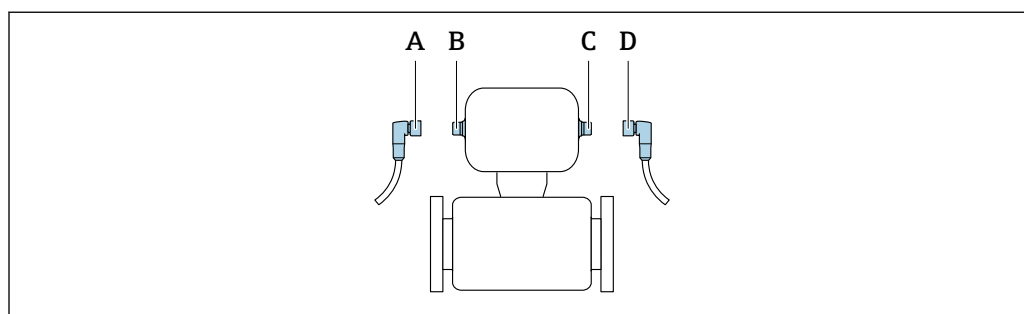

- Totalizers stop at the last value measured.
- Error messages (incl. total operated hours) are stored.

Electrical connection Connection is solely by means of device plug:



A, C Coupling
B, D Plug

There are different device versions available:

Order code for "Output, input":	Device plug
Option 3: 2 pulse/frequency/switch outputs	→  11
Option 4: Modbus RS485, 1 switch output (batch), 1 status input	→  12
Option 5: Modbus RS485, 2 switch outputs (batch), 1 status input	→  13

Grounding

Grounding is by means of a cable socket.

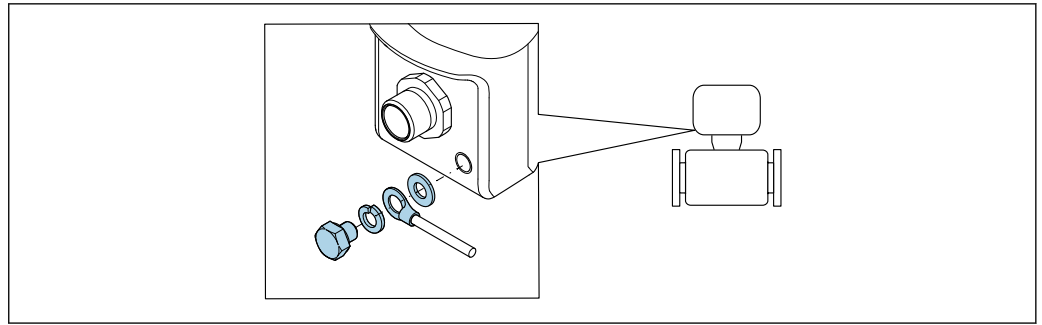

A0007235

Potential equalization

Requirements

No special measures for potential equalization are required.



For devices intended for use in hazardous locations, please observe the guidelines in the Ex documentation (XA).

Cable specification

Permitted temperature range

- -40 °C (-40 °F) to +80 °C (+176 °F)
- Minimum requirement: cable temperature range ≥ ambient temperature +20 K

Signal cable



Cables are not included in the scope of delivery; they can be ordered as an accessory → 35.

Pulse/frequency/switch output

Standard installation cable is sufficient.

Status input and switch output (batch)

Standard installation cable is sufficient.

Modbus RS485



- The electrical connection of the shield to the device housing must be properly implemented (e.g. using a knurled nut).
- Please note the following with regard to cable loading:
 - Voltage drop due to the cable length and cable type.
 - Valve performance.

Total length of cable in the Modbus network ≤ 50 m

Use a shielded cable.

Example:

Terminated device connector with cable: Lumberg RKWTH 8-299/10

Total length of cable in the Modbus network > 50 m

Use shielded twisted pair cable for RS485 applications.

Example:



- Cable: Belden item no. 9842 (for 4-wire version, the same cable can be used for the power supply)
- Terminated device plug: Lumberg RKCS 8/9 (shieldable version)

Performance characteristics

Reference operating conditions

Error limits based on ISO 11631

- Water at +15 to +45 °C (+59 to +113 °F) at 2 to 6 bar (29 to 87 psi)
- Specifications as per calibration protocol
- Accuracy based on accredited calibration rigs that are traced to ISO 17025.

 To obtain measured errors, use the *Applicator* sizing tool →  36

Maximum measured error

o.r. = of reading; 1 g/cm³ = 1 kg/l; T = medium temperature

Base accuracy

Mass flow and volume flow (liquids)

- ±0.15 % o.r.
- ±0.30 % ± [(zero point stability : measured value) · 100] % o.r.
- ±5 % ± [(zero point stability : measured value) · 100] % o.r.

Density (liquids)

- Reference operating conditions: ±0.0005 g/cm³
- Field density calibration: ±0.0005 g/cm³
(after field density calibration under process conditions)
- Standard density calibration: ±0.02 g/cm³
(valid over the entire temperature range and density range)

Temperature

±0.5 °C ± 0.005 · T °C (±0.9 °F ± 0.003 · (T - 32) °F)

Zero point stability

DN		Zero point stability	
[mm]	[in]	[kg/h]	[lb/min]
8	³ / ₈	0.20	0.007
15	¹ / ₂	0.65	0.024
25	1	1.80	0.066

Flow values

Flow values as turndown parameter depending on nominal diameter.

SI units

DN	1:1	1:10	1:20	1:50	1:100	1:500
[mm]	[kg/h]	[kg/h]	[kg/h]	[kg/h]	[kg/h]	[kg/h]
8	2000	200	100	40	20	4
15	6500	650	325	130	65	13
25	18000	1800	900	360	180	36

US units

DN	1:1	1:10	1:20	1:50	1:100	1:500
[inch]	[lb/min]	[lb/min]	[lb/min]	[lb/min]	[lb/min]	[lb/min]
³ / ₈	73.50	7.350	3.675	1.470	0.735	0.147
¹ / ₂	238.9	23.89	11.95	4.778	2.389	0.478
1	661.5	66.15	33.08	13.23	6.615	1.323

Accuracy of outputs

 In the case of analog outputs, the output accuracy must also be considered for the measured error, in contrast, this need not be considered in the case of fieldbus outputs (Modbus RS485). The outputs have the following base accuracy specifications.

Pulse/frequency output

o.r. = of reading

Accuracy	Max. ±50 ppm o.r. (across the entire ambient temperature range)
-----------------	---

Repeatability

Base repeatability

Dosing time [s]	Standard deviation [%]
≥ 0.75	0.2
≥ 1.5	0.1
≥ 3.0	0.05

Density (liquids)

±0.00025 g/cm³

Temperature

±0.25 °C ± 0.0025 · T °C (±0.45 °F ± 0.0015 · (T-32) °F)

Response time

The response time depends on the configuration (damping).

Influence of ambient temperature

Pulse/frequency output

Temperature coefficient	No additional effect. Included in accuracy.
--------------------------------	---

Influence of medium temperature

Mass flow

If there is a differential between the temperature during zero point adjustment and the process temperature, the typical measured error of the sensor is ±0.0003 % of the full scale value/°C (±0.00015 % of the full scale value/°F).

Temperature

±0.005 · T °C (± 0.005 · (T - 32) °F)

Influence of medium pressure

A difference between the calibration pressure and process pressure does not affect accuracy.

Installation

No special measures such as supports etc. are necessary. External forces are absorbed by the construction of the device.

Mounting location

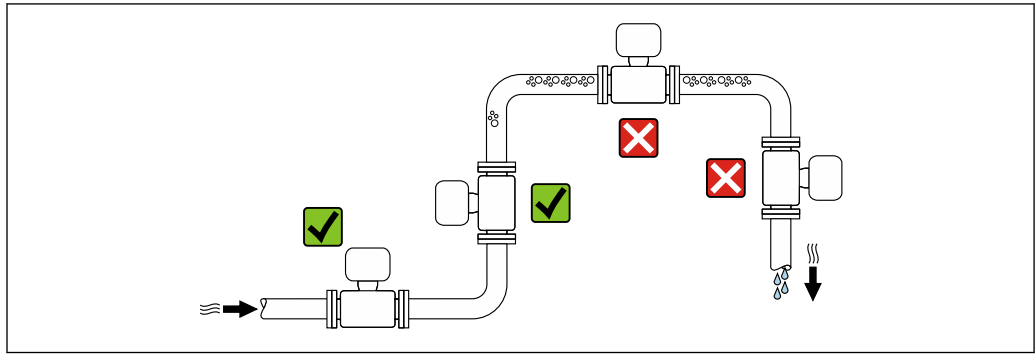

A0028772

To prevent measuring errors arising from accumulation of gas bubbles in the measuring tube, avoid the following mounting locations in the pipe:

- Highest point of a pipeline.
- Directly upstream of a free pipe outlet in a down pipe.

Installation in down pipes

However, the following installation suggestion allows for installation in an open vertical pipeline. Pipe restrictions or the use of an orifice with a smaller cross-section than the nominal diameter prevent the sensor running empty while measurement is in progress.

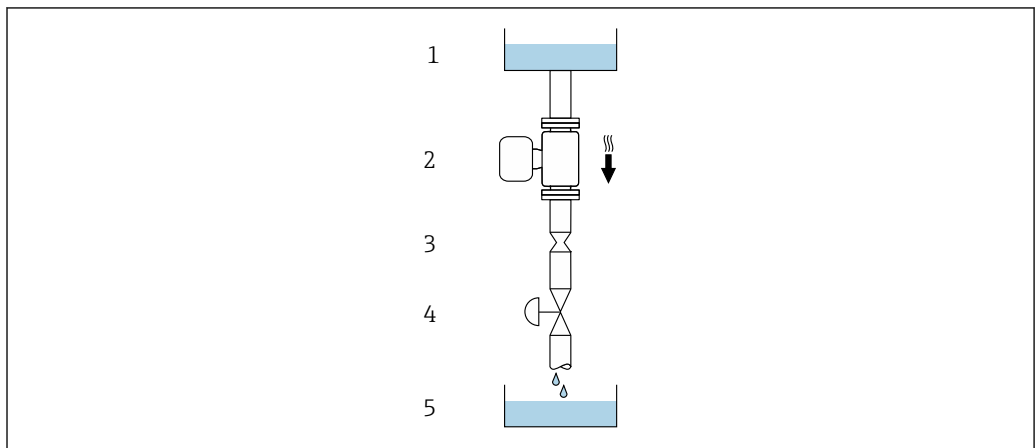

A0028773





6 Installation in a down pipe (e.g. for batching applications)

- 1 Supply tank
- 2 Sensor
- 3 Orifice plate, pipe restriction
- 4 Valve
- 5 Batching tank

DN		Ø orifice plate, pipe restriction	
[mm]	[in]	[mm]	[in]
8	3/8	6	0.24
15	1/2	10	0.40
25	1	14	0.55

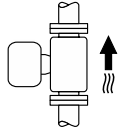
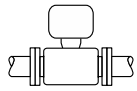
Orientation

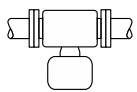
The direction of the arrow on the sensor nameplate helps you to install the sensor according to the flow direction (direction of medium flow through the piping).

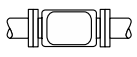
Orientation		Recommendation
A	Vertical orientation	 A0015591 ✓✓
B	Horizontal orientation, transmitter at top	 A0015589 ✓✓ ¹⁾ →  , 
C	Horizontal orientation, transmitter at bottom	 A0015590 ✓✓ ²⁾ →  , 
D	Horizontal orientation, transmitter at side	 A0015592 ✗

- 1) Applications with low process temperatures may decrease the ambient temperature. To maintain the minimum ambient temperature for the transmitter, this orientation is recommended.
- 2) Applications with high process temperatures may increase the ambient temperature. To maintain the maximum ambient temperature for the transmitter, this orientation is recommended.

If a sensor is installed horizontally with a curved measuring tube, match the position of the sensor to the fluid properties.

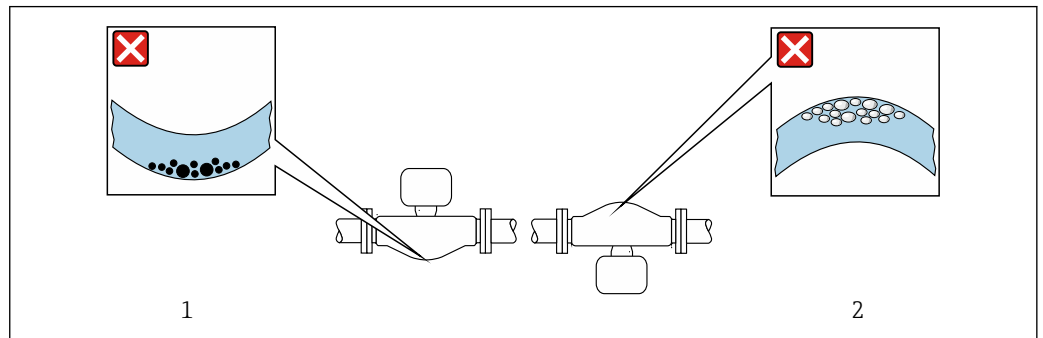

 7 Orientation of sensor with curved measuring tube

- 1 Avoid this orientation for fluids with entrained solids: Risk of solids accumulating.
- 2 Avoid this orientation for outgassing fluids: Risk of gas accumulating.

Valves

Never install the sensor downstream from a filling valve. If the sensor is completely empty this corrupts the measured value.

-  Correct measurement is only possible if the pipe is completely full. Perform sample fillings before commencing filling in production.

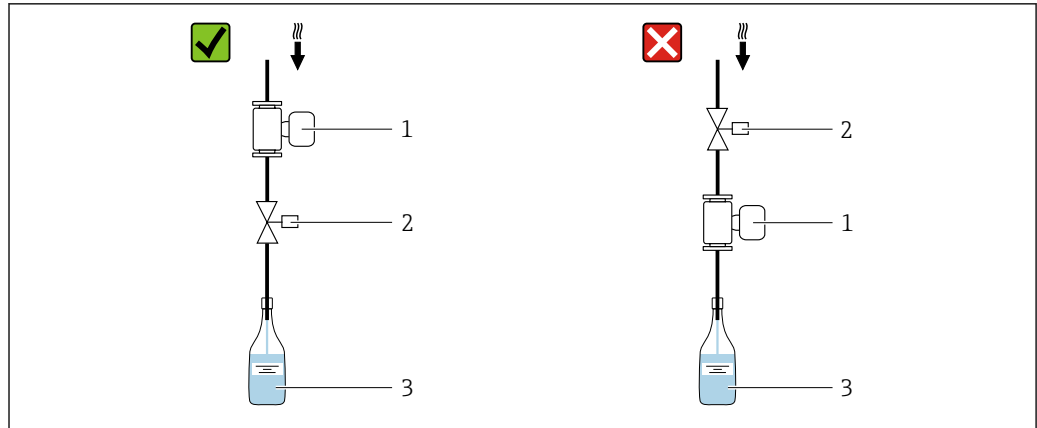

A0003768

- 1 Measuring device
- 2 Filling valve
- 3 Container

Filling systems

The pipe system must be completely full to ensure optimum measurement.

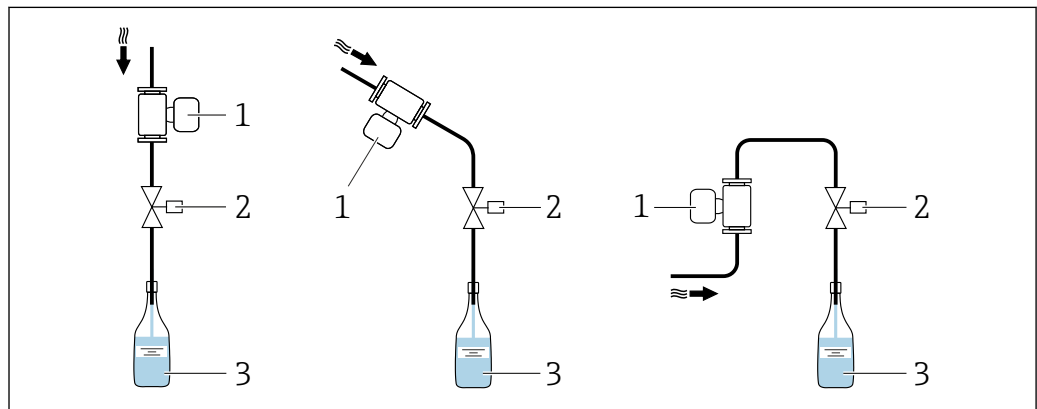

A0003795

- 8 Filling system
- 1 Measuring device
- 2 Filling valve
- 3 Container

Inlet and outlet runs

No special precautions need to be taken for fittings which create turbulence, such as valves, elbows or T-pieces, as long as no cavitation occurs .

Special mounting instructions

Information for filling systems

Correct measurement is possible only if the piping is completely filled. We therefore recommend that some test batches be carried out prior to production batching.

Circular filling system

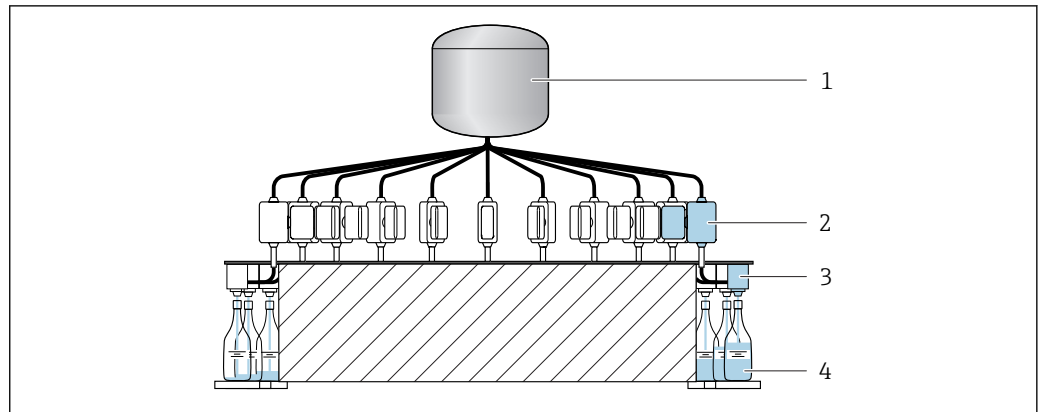

A0003761

- 1 Tank
- 2 Measuring device
- 3 Batching valve
- 4 Vessel

Linear filling system

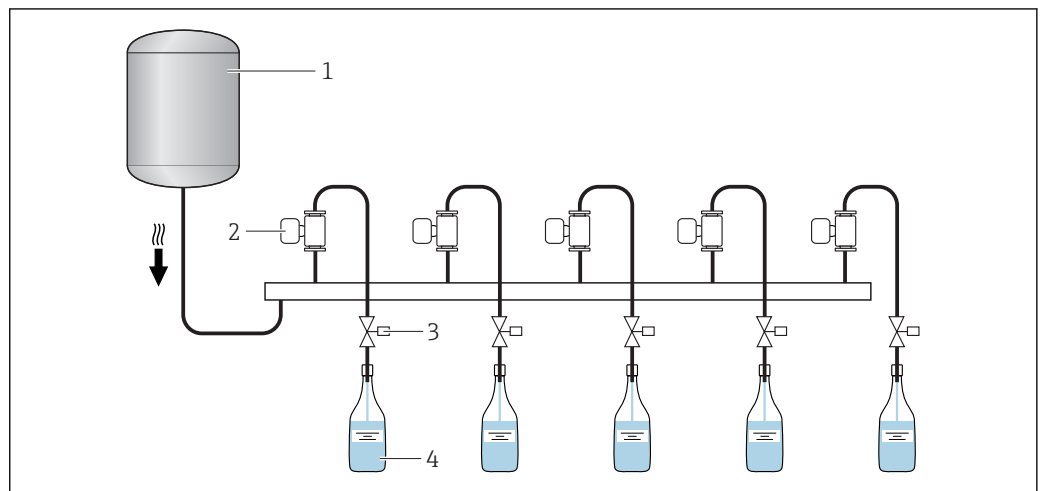

A0003762

- 1 Tank
- 2 Measuring device
- 3 Batching valve
- 4 Vessel

Zero point adjustment

The **Sensor adjustment** submenu contains parameters required for zero point adjustment.

NOTICE

All Dosimass measuring devices are calibrated in accordance with state-of-the-art technology. Calibration takes place under reference conditions .

Therefore, a zero point adjustment is generally not required for the Dosimass!

- ▶ Experience shows that a zero point adjustment is advisable only in special cases.
- ▶ When maximum accuracy is required and flow rates are very low.
- ▶ Under extreme process or operating conditions (e.g. very high process temperatures or very high-viscosity fluids).



Detailed information on reference conditions → 16

Environment

Ambient temperature range	Transmitter	-40 to +60 °C (-40 to +140 °F)
	Sensor	-40 to +60 °C (-40 to +140 °F)

Temperature tables

The following interdependencies between the permitted ambient and fluid temperatures apply when operating the device in hazardous areas:

Ex nA

SI units



T_a [°C]	Maximum medium temperature T_m				
	T5 [100 °C]	T4 [135 °C]	T3 [200 °C]	T2 [300 °C]	T1 [450 °C]
60	90	125	125	125	125

US units

T_a [°F]	Maximum medium temperature T_m				
	T5 [212 °F]	T4 [275 °F]	T3 [392 °F]	T2 [572 °F]	T1 [842 °F]
140	194	257	257	257	257

The minimum temperature of the medium is -40 °C (-40 °F).

The minimum ambient temperature is -40 °C (-40 °F).

Storage temperature	-40 to +80 °C (-40 to +176 °F), preferably at +20 °C (+68 °F)
Degree of protection	As standard: IP67, type 4X enclosure
Shock resistance	As per IEC/EN 60068-2-31
Vibration resistance	Acceleration up to 1 g, 10 to 150 Hz, based on IEC/EN 60068-2-6
Interior cleaning	<ul style="list-style-type: none"> ▪ Cleaning in place (CIP) ▪ Sterilization in place (SIP) <p> Observe the maximum medium temperatures →  22</p>
Electromagnetic compatibility (EMC)	<p>According to IEC/EN 61326</p> <p> For details, refer to the Declaration of Conformity.</p>

Process

Medium temperature range	Sensor	-40 to +125 °C (-40 to +257 °F)
	Cleaning	+150 °C (+302 °F) / 60 min for CIP and SIP processes
	Seals	No internal seals

Medium pressure range (nominal pressure) max. 40 bar (580 psi), depending on process connection

Density 0 to 5 000 kg/m³ (0 to 312 lb/cf)

Pressure-temperature ratings The following pressure-temperature ratings refer to the entire device and not just the process connection.

Process connection: flange connection according to EN 1092-1 (DIN 2501)

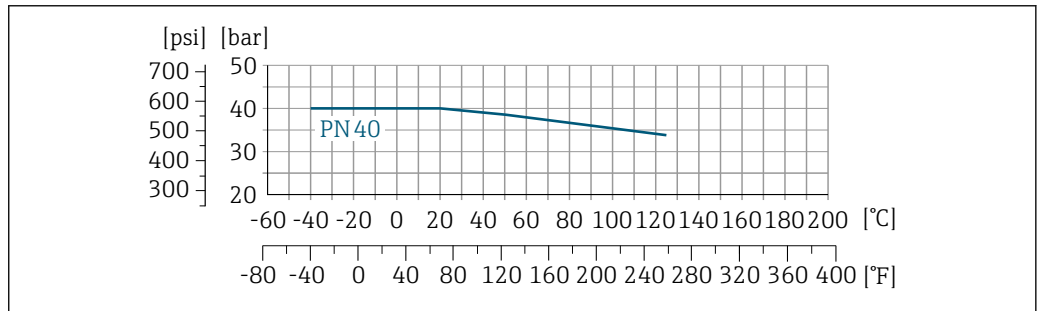

9 Process connection material: stainless steel 1.4404 (316L/316)

Process connection: sanitary connection according to DIN 11851/SMS 1145

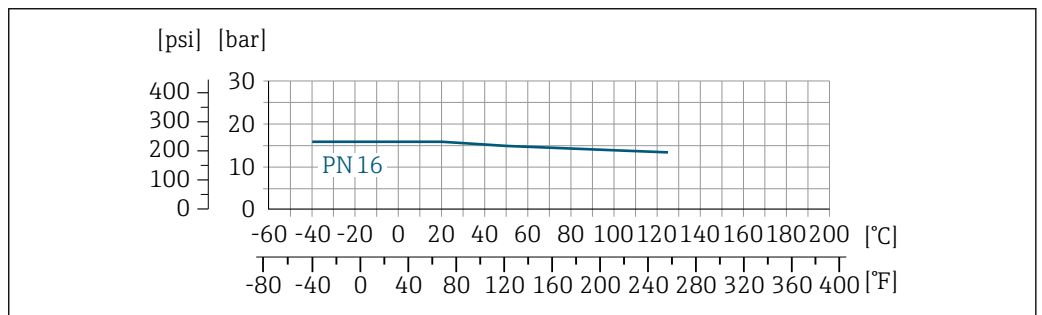

10 Process connection material: stainless steel 1.4404 (316L)

Process connection: coupling according to DIN 11864-1

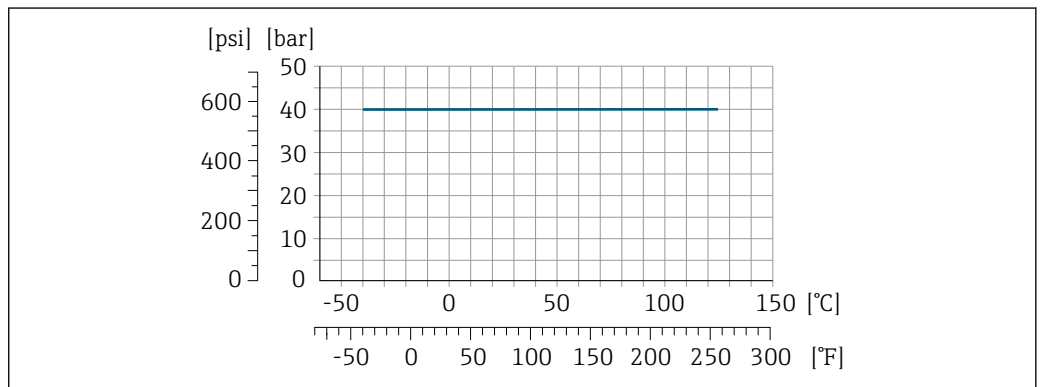

11 Process connection material: stainless steel 1.4404 (316L)

Process connection: coupling according to ISO 2853

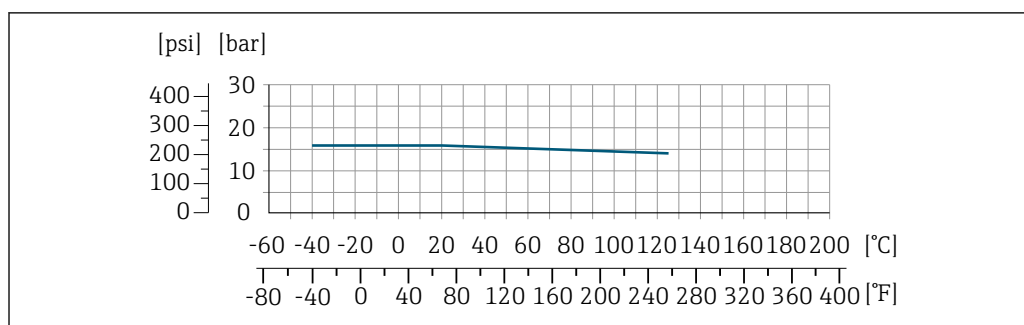

A0023112-EN

12 Process connection material: stainless steel 1.4404 (316L)

Process connection: connection according to DIN 32676 (Clamp)

PS = 16 bar (232 psi)

The clamp connections are suitable up to a maximum pressure of 16 bar (232 psi). Please observe the operating limits of the clamp and seal used as they could be under 16 bar (232 psi). The clamp and seal are not included in the scope of supply.

Process connection: Tri-Clamp

The load limit is defined exclusively by the material properties of the Tri-Clamp clamp used. This clamp is not included in the scope of delivery.

Secondary containment pressure rating

The housing does not have pressure vessel classification.

Flow limit

Select the nominal diameter by optimizing between the required flow range and permissible pressure loss.

i For an overview of the full scale values for the measuring range, see the "Measuring range" section → 7

- The minimum recommended full scale value is approx. 1/20 of the maximum full scale value
- For the most common applications, 20 to 50 % of the maximum full scale value can be considered ideal
- Select a low full scale value for abrasive media (e.g. liquids with entrained solids): Flow velocity < 1 m/s (< 3 ft/s).

Pressure loss

i To calculate the pressure loss, use the *Applicator* sizing tool → 36

Heating

Some fluids require suitable measures to avoid loss of heat at the sensor.

Heating options

- Electrical heating, e.g. with electric band heaters
- Via pipes carrying hot water or steam
- Via heating jackets

NOTICE

Danger of overheating when heating

- ▶ Ensure that the temperature at the lower end of the transmitter housing does not exceed 80 °C (176 °F)
- ▶ Ensure that convection takes place on a sufficiently large scale at the transmitter neck.
- ▶ Ensure that a sufficiently large area of the housing support remains exposed. The uncovered part serves as a radiator and protects the electronics from overheating and excessive cooling.

Vibrations

The high oscillation frequency of the measuring tubes ensures that the correct operation of the measuring system is not influenced by plant vibrations.

Mechanical construction

Dimensions in SI units

Compact version

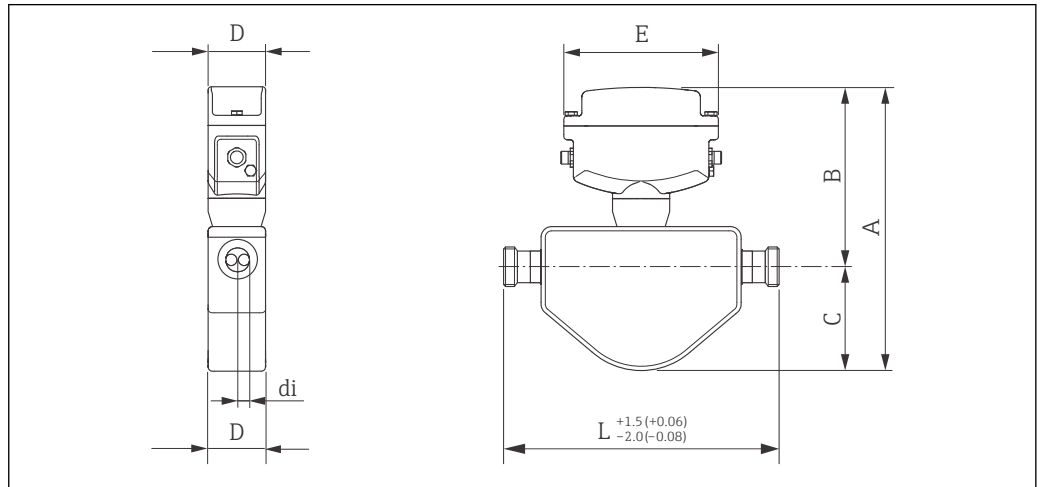

DN [mm]	L [mm]	A [mm]	B [mm]	C [mm]	D [mm]	E [mm]	di [mm]
8	¹⁾	253	160	93	54	146	5.35
15	¹⁾	267	162	105	54	146	8.30
25	¹⁾	273	167	106	54	146	12.00

1) Depending on the process connection in question

Fixed flange

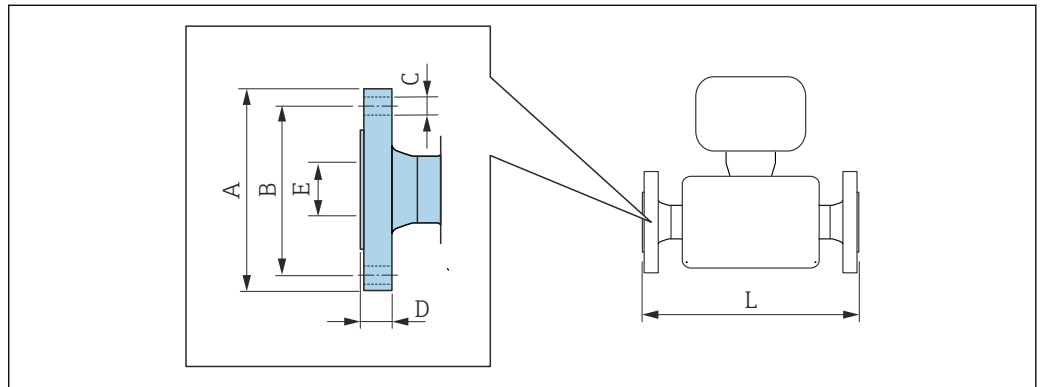

 Length tolerance for dimension L in mm:
+1.5 / -2.0

Fixed flange as per EN 1092-1 (DIN 2501 ¹⁾): PN 40 1.4404 (316L): Order code for "Process connection", option D2S						
DN [mm]	L [mm]	A [mm]	B [mm]	C [mm]	D [mm]	E [mm]
8	232	95	65	4 × Ø 14	16	17.3
15	279	95	65	4 × Ø 14	16	17.3
25	329	115	85	4 × Ø 14	18	28.5

1) flange with groove as per EN 1092-1 Form D (DIN 2512N) available

Tri-Clamp

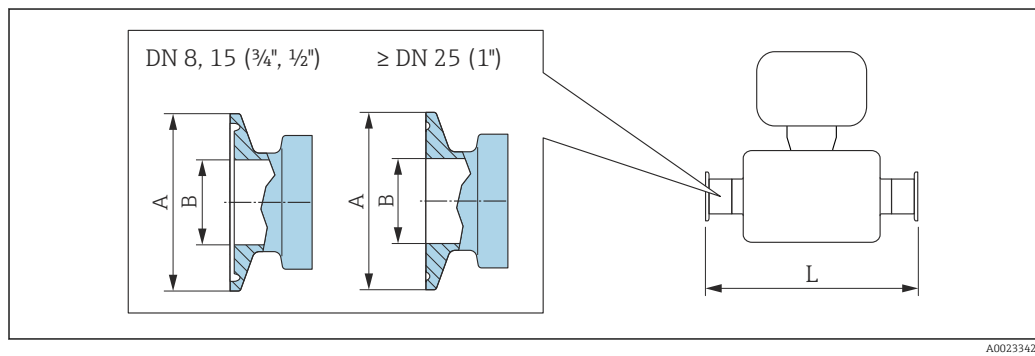

A0023342

i Length tolerance for dimension L in mm:
+1.5 / -2.0

1/2" Tri-Clamp BS4825-3 1.4404 (316L): Order code for "Process connection", option FUW			
DN [mm]	L [mm]	A [mm]	B [mm]
8	229	25.0	9.5
15	273	25.0	9.5

Surface roughness (3A version):

- Mechanically polished: Ra_{max} 0.76 µm/150 grit; order code for "Process connection", option FUA
- Electropolished: Ra_{max} 0.38 µm/240 grit; order code for "Process connection", option FUD

3/4" Tri-Clamp 1.4404 (316L): order code for "Process connection", option FWW			
DN [mm]	L [mm]	A [mm]	B [mm]
8	229	25.0	15.75
15	273	25.0	15.75

Surface roughness (3A version):
Mechanically polished: Ra_{max} 0.76 µm/150 grit; order code for "Process connection", option FWA

1" Tri-Clamp 1.4404 (316L): order code for "Process connection", option FTS			
DN [mm]	L [mm]	A [mm]	B [mm]
8	229	50.4	22.1
15	273	50.4	22.1

1" Tri-Clamp
 1.4404 (316L): order code for "Process connection", option FTS

DN [mm]	L [mm]	A [mm]	B [mm]
25	324	50.4	22.1

Surface roughness (3A version):

- Mechanically polished: Ra_{max} 0.76 μ m/150 grit; order code for "Process connection", option FTA
- Electropolished: Ra_{max} 0.38 μ m/240 grit; order code for "Process connection", option FTD

Clamp connection

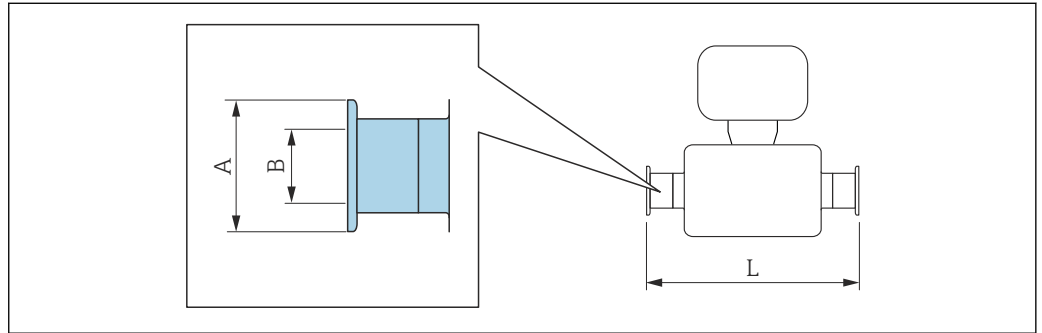

A0015625

i Length tolerance for dimension L in mm:
 +1.5 / -2.0

1" clamp DIN 32676
 1.4404 (316L): order code for "Process connection", option FDD

DN [mm]	L [mm]	A [mm]	B [mm]
8	229	34.0	16
15	273	34.0	16
25	324	50.5	26

Surface roughness
 Electropolished: Ra_{max} 0.38 μ m/240 grit

Threaded adapter

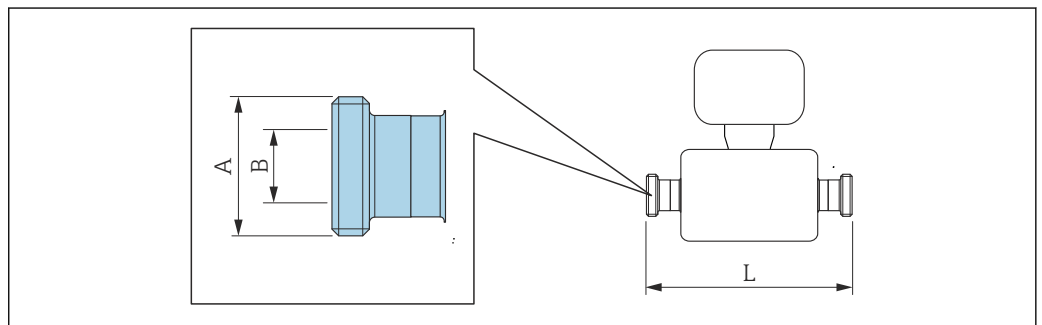

A0015628

i Length tolerance for dimension L in mm:
 +1.5 / -2.0

Threaded hygienic connection DIN 11864-1 Form A
 1.4404 (316L): order code for "Process connection", option FLW

DN [mm]	L [mm]	A [mm]	B [mm]
8	229	Rd 28 × 1/8"	10
15	273	Rd 34 × 1/8"	16
25	324	Rd 52 × 1/6"	26

Surface roughness (3A version):
 Mechanically polished: Ra_{max} 0.76 µm/150 grit; order code for "Process connection", option FLA

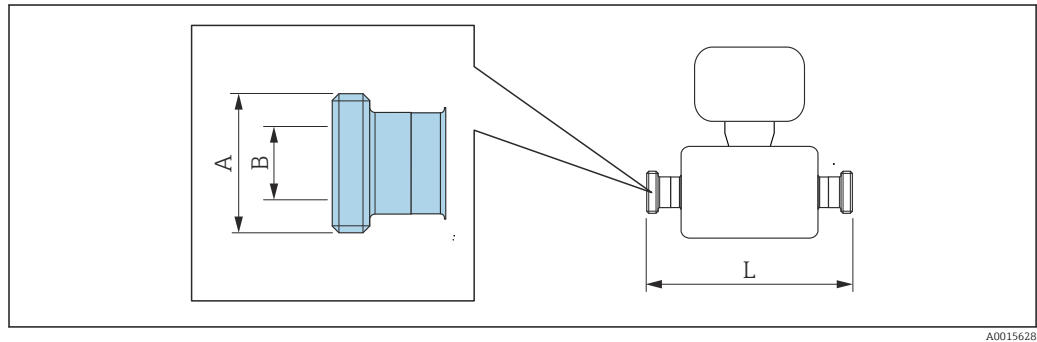

A0015628

i Length tolerance for dimension L in mm:
 +1.5 / -2.0

Sanitary connection DIN 11851
 1.4404 (316L): order code for "Process connection", option FMW

DN [mm]	L [mm]	A [mm]	B [mm]
8	229	Rd 34 × 1/8"	16
15	273	Rd 34 × 1/8"	16
25	324	Rd 52 × 1/6"	26

Surface roughness (3A version):
 Mechanically polished: Ra_{max} 0.76 µm/150 grit; order code for "Process connection", option FMA

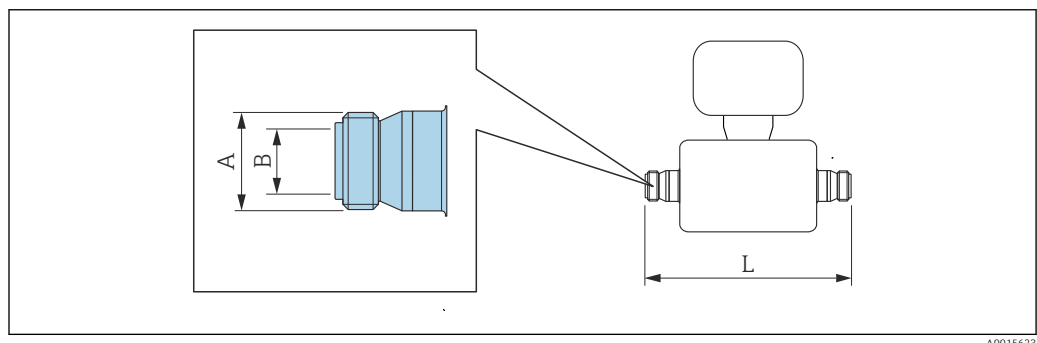

A0015623

i Length tolerance for dimension L in mm:
 +1.5 / -2.0

Threaded hygienic connection ISO 2853
 1.4404 (316L): order code for "Process connection", option FJW

DN [mm]	L [mm]	A ¹⁾ [mm]	B [mm]
8	229	37.13	22.6
15	273	37.13	22.6
25	324	37.13	22.6

Surface roughness (3A version):
 Mechanically polished: Ra_{max} 0.76 µm/150 grit; order code for "Process connection", option FJA

1) Max. thread diameter as per ISO 2853 Annex A

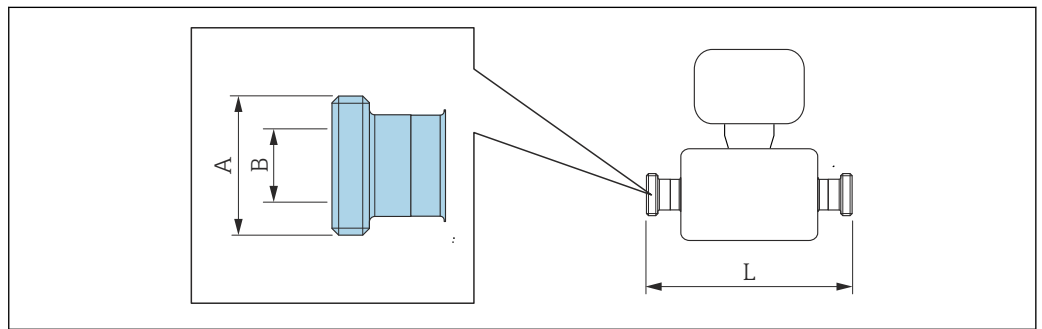

A0015628

 Length tolerance for dimension L in mm:
 +1.5 / -2.0

Threaded hygienic connection SMS 1145
 1.4404 (316L): order code for "Process connection", option FSW

DN [mm]	L [mm]	A [mm]	B [mm]
8	229	Rd 40 x 1/6"	22.5
15	273	Rd 40 x 1/6"	22.5
25	324	Rd 40 x 1/6"	22.5

Surface roughness (3A version):
 Mechanically polished: Ra_{max} 0.76 µm/150 grit; order code for "Process connection", option FSA

Dimensions in US units

Compact version

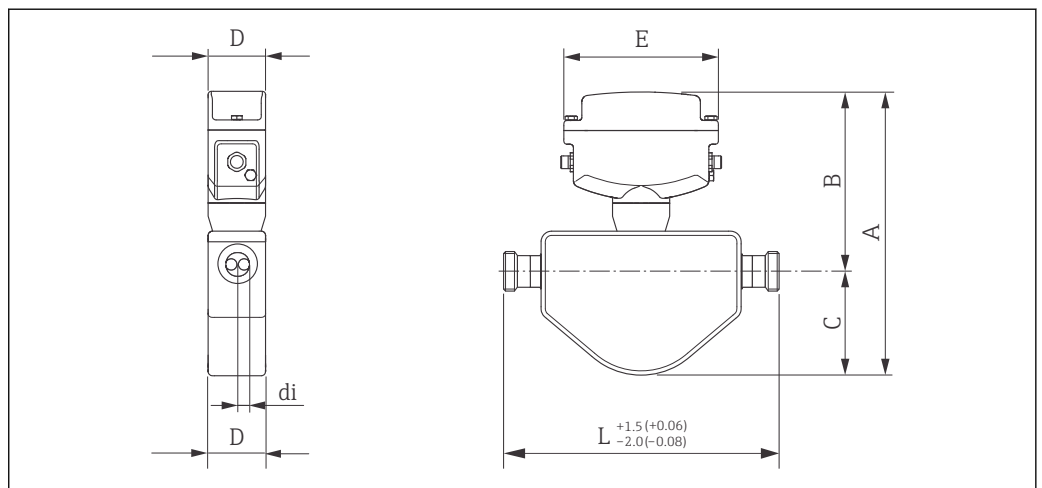

A0008574

DN [in]	L [in]	A [in]	B [in]	C [in]	D [in]	E [in]	di [in]
3/8	¹⁾	9.96	6.30	3.66	2.13	5.75	0.21
1/2	¹⁾	10.50	6.38	4.13	2.13	5.75	0.33
1	¹⁾	10.80	6.57	4.17	2.13	5.75	0.47

1) Depending on the process connection in question

Tri-Clamp

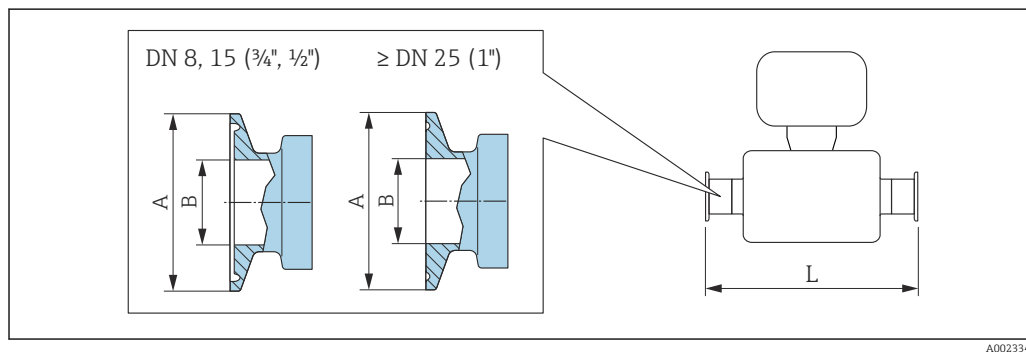

 Length tolerance for dimension L in inch:
+0.06 / -0.08

1/2" Tri-Clamp BS4825-3 1.4404 (316L): Order code for "Process connection", option FUW ¹⁾			
DN [in]	L [in]	A [in]	B [in]
3/8	9.02	0.98	0.37
1/2	10.80	0.98	0.37

Surface roughness (3A version):

- Mechanically polished: Ra_{max} 0.76 µm/150 grit; order code for "Process connection", option FUA
- Electropolished: Ra_{max} 0.38 µm/240 grit; order code for "Process connection", option FUD

1) 3A version available (Ra ≤ 0.8 µm/150 grit or Ra ≤ 0.4 µm/240 grit)

3/4" Tri-Clamp BS4825-3 1.4404 (316L): Order code for "Process connection", option FUW ¹⁾			
DN [in]	L [in]	A [in]	B [in]
3/8	9.02	0.98	0.62
1/2	10.80	0.98	0.62

Surface roughness (3A version):
Mechanically polished: Ra_{max} 0.76 µm/150 grit; order code for "Process connection", option FWA

1) 3A version available (Ra ≤ 0.8 µm/150 grit)

1" Tri-Clamp BS4825-3 1.4404 (316L): order code for "Process connection", option FTS ¹⁾			
DN [in]	L [in]	A [in]	B [in]
3/8	9.02	1.98	0.87
1/2	10.80	1.98	0.87
1	12.80	1.98	0.87

Surface roughness (3A version):

- Mechanically polished: Ra_{max} 0.76 µm/150 grit; order code for "Process connection", option FTA
- Electropolished: Ra_{max} 0.38 µm/240 grit; order code for "Process connection", option FTD

1) 3A version available (Ra ≤ 0.8 µm/150 grit or Ra ≤ 0.4 µm/240 grit)

Threaded adapter

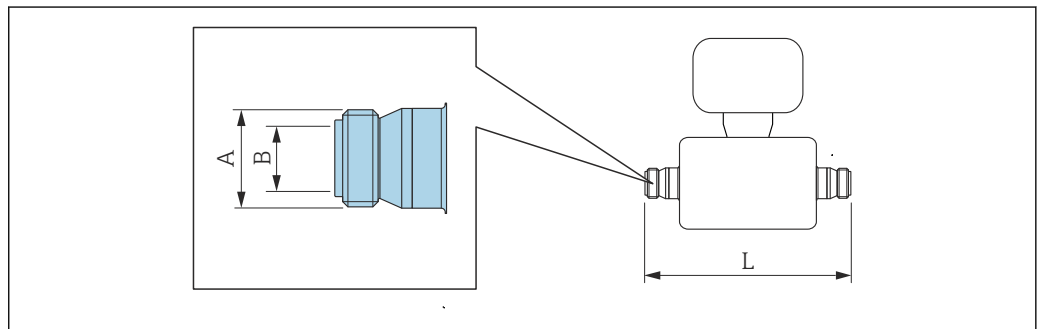

A0015623

i Length tolerance for dimension L in inch:
+0.06 / -0.08

Threaded connection ISO 2853 1.4404 (316L): order code for "Process connection", option FJW			
DN [in]	L [in]	A ¹⁾ [in]	B [in]
3/8	9.02	1.46	0.89
1/2	10.80	1.46	0.89
1	12.80	1.46	0.89

Surface roughness (3A version):
Mechanically polished: Ra_{max} 0.76 µm/150 grit; order code for "Process connection", option FJA

1) Max. thread diameter as per ISO 2853 Annex A

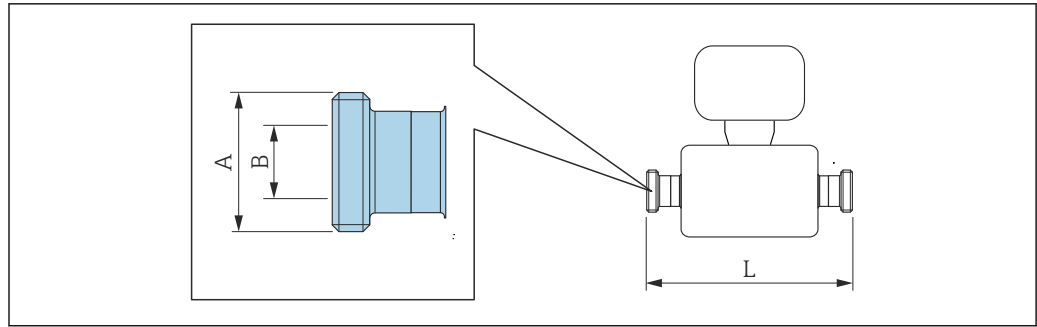

A0015628

i Length tolerance for dimension L in inch:
+0.06 / -0.08

Threaded connection SMS 1145			
1.4404 (316L): order code for "Process connection", option FSW			
DN [in]	L [in]	A [in]	B [in]
3/8	9.02	Rd 40 × 1/8"	0.89
1/2	10.80	Rd 40 × 1/6"	0.89
1	12.80	Rd 40 × 1/6"	0.89

Surface roughness (3A version):
Mechanically polished: Ra_{max} 0.76 µm/150 grit; order code for "Process connection", option FSA

Weight

Compact version

Weight in SI units

DN [mm]	Weight [kg]
8	3.5
15	4.0
25	4.5

Weight in US units

DN [in]	Weight [lbs]
3/8	7.7
1/2	8.8
1	9.9

Materials

Transmitter housing

- Acid and alkali-resistant outer surface
- Stainless steel 1.4308 (304)

Device plugs

Electrical connection	Material
Plug M12x1	<ul style="list-style-type: none"> ▪ Socket: Stainless steel, 1.4404 (316L) ▪ Contact housing: Polyamide ▪ Contacts: Gold-plated brass

Sensor housing

- Acid and alkali-resistant outer surface
- Stainless steel 1.4301 (304)

Measuring tubes

Stainless steel, 1.4539 (904L)

Process connections

- Flanges according to EN (DIN):
Stainless steel, 1.4404 (316/316L)
- Flanges according to DIN 32676:
Stainless steel, 1.4435 (316L)
- All other process connections:
Stainless steel, 1.4404 (316L)

 List of all available process connections →  33

Surface quality (parts in contact with medium)

- Ra_{max} = 0.4 µm (16 µin)
- Ra_{max} = 0.8 µm (32 µin)

Seals

Welded process connections without internal seals

Process connections

Flanges

EN 1092-1 (DIN 2512N)

Tri-Clamp (OD tubes)



BS4825-3

Clamp with compression fitting

DIN 32676

Threaded adapter

- DIN 11851
- SMS 1145
- ISO 2853
- DIN 11864-1 Form A

 For information on the different materials used in the process connections →  33

Operability

Local operation

This device cannot be operated locally using a display or operating elements.

Remote operation

Using service adapter and Commubox FXA291

Operation and configuration can be performed using the Endress+Hauser FieldCare or DeviceCare service and configuration software.

The device is connected to the USB port of the computer via the service adapter and Commubox FXA291.

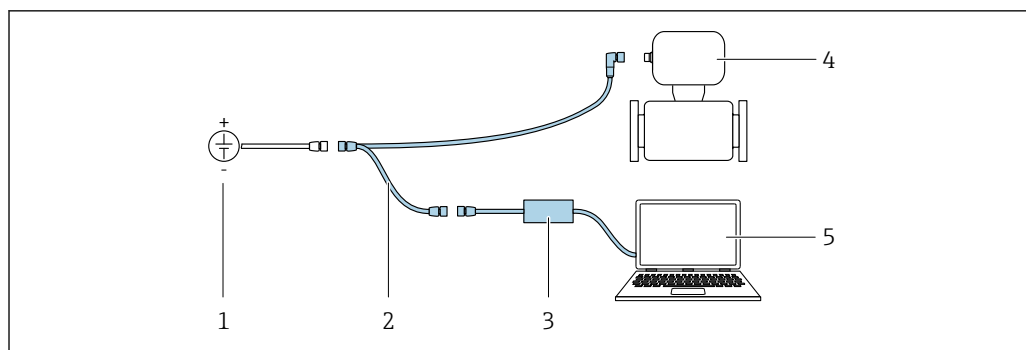

A0032567

- 1 Supply voltage 24 V DC
- 2 Service adapter
- 3 Commubox FXA291
- 4 Measuring device
- 5 Computer with "FieldCare" or "DeviceCare" operating tool

i The service adapter, cable and Commubox FXA291 are not included in the delivery. These components can be ordered as accessories → 35.

Certificates and approvals

CE mark The measuring system is in conformity with the statutory requirements of the applicable EC Directives. These are listed in the corresponding EC Declaration of Conformity along with the standards applied.
Endress+Hauser confirms successful testing of the device by affixing to it the CE mark.

C-Tick symbol The measuring system meets the EMC requirements of the "Australian Communications and Media Authority (ACMA)".

Ex approval The measuring device is certified for use in hazardous areas and the relevant safety instructions are provided in the separate "Safety Instructions" (XA) document. Reference is made to this document on the nameplate.
i The separate Ex documentation (XA) containing all the relevant explosion protection data is available from your Endress+Hauser sales center.

ATEX

Currently, the following versions for use in hazardous areas are available:

Ex nA

Category (ATEX)	Type of protection
IIG	Ex nA IIC T5 to T1 Gc

cCSAus

Currently, the following versions for use in hazardous areas are available:

Class I Division 2 Groups ABCD

Hygienic compatibility 3A approval

Pressure Equipment Directive

- With the PED/G1/x (x = category) marking on the sensor nameplate, Endress+Hauser confirms compliance with the "Essential Safety Requirements" specified in Annex I of the Pressure Equipment Directive 97/23/EC.
- Devices bearing this marking (PED) are suitable for the following types of medium:
 - Media in Group 1 and 2 with a vapor pressure greater than, or smaller and equal to 0.5 bar (7.3 psi)
 - Unstable gases
- Devices not bearing this marking (PED) are designed and manufactured according to good engineering practice. They meet the requirements of Art.3 Section 3 of the Pressure Equipment Directive 97/23/EC. The range of application is indicated in tables 6 to 9 in Annex II of the Pressure Equipment Directive.

Other standards and guidelines

- EN 60529
Degrees of protection provided by enclosures (IP code)
- EN 61010-1
Safety Requirements for Electrical Equipment for Measurement, Control and Laboratory Use
- IEC/EN 61326
Emission in accordance with Class A requirements. Electromagnetic compatibility (EMC requirements).
- EN 61000-4-3 (IEC 1000-4-3)
Operating behavior A with shielded connecting cable possible (shielding connected as short as possible on both sides), otherwise operating behavior B
- NAMUR NE 21
Electromagnetic compatibility of industrial process and laboratory control equipment
- CAN/CSA C22.2 No. 61010-1-12
Safety Requirements for Electrical Equipment for Measurement, Control and Laboratory Use, Part 1: General Requirements

Ordering information

Detailed ordering information is available from the following sources:

- In the Product Configurator on the Endress+Hauser website: www.endress.com -> Click "Corporate" -> Select your country -> Click "Products" -> Select the product using the filters and search field -> Open product page -> The "Configure" button to the right of the product image opens the Product Configurator.
- From your Endress+Hauser Sales Center: www.addresses.endress.com



Product Configurator - the tool for individual product configuration



- Up-to-the-minute configuration data
- Depending on the device: Direct input of measuring point-specific information such as measuring range or operating language
- Automatic verification of exclusion criteria
- Automatic creation of the order code and its breakdown in PDF or Excel output format
- Ability to order directly in the Endress+Hauser Online Shop

Accessories



Various accessories, which can be ordered with the device or subsequently from Endress+Hauser, are available for the device. Detailed information on the order code in question is available from your local Endress+Hauser sales center or on the product page of the Endress+Hauser website: www.endress.com.

Communication-specific accessories

Accessories	Description
FieldCare	FDT-based plant asset management tool from Endress+Hauser. It can configure all smart field units in your system and helps you manage them. By using the status information, it is also a simple but effective way of checking their status and condition.  For details, see Operating Instructions BA00027S and BA00059S

DeviceCare	<p>Tool for connecting and configuring Endress+Hauser field devices.</p>  For details, see Innovation brochure IN01047S
Commubox FXA291	<p>Connects Endress+Hauser field devices with a CDI interface (= Endress+Hauser Common Data Interface) and the USB port of a computer or laptop.</p>  For details, see the "Technical Information" document TI405C/07
Adapter connection	<p>Adapter connections for installation on other electrical connections:</p> <ul style="list-style-type: none"> ■ Adapter FXA291 (order number: 71035809) ■ Adapter RSE8 (order number: 50107169) RSE8 connection jack, 8-pin adapter (RSE8), 24 V DC, pulse, status ■ Adapter RSE5 (order number: 50107168) RSE8 connection jack, 5-pin adapter (RSE5), 24 V DC, pulse, status ■ Adapter RSE4 (order number: 50107167) RSE8 connection jack, 4-pin adapter (RSE4), 24 V DC, pulse
Connecting cable RSE8	<p>Cable RKWTN8-56/5 P92, length: 5 m (Order number: 50107895)</p>

Service-specific accessories

Accessories	Description
Applicator	<p>Software for selecting and sizing Endress+Hauser measuring devices:</p> <ul style="list-style-type: none"> ■ Calculation of all data required to determine the optimum flowmeter: e.g. nominal diameter, pressure loss, accuracy or process connections. ■ Graphic illustration of the calculation results <p>Administration, documentation and access to all project-related data and parameters throughout the entire life cycle of a project.</p> <p>Applicator is available:</p> <ul style="list-style-type: none"> ■ Via the Internet: https://wapps.endress.com/applicator ■ On CD-ROM for local PC installation.
W@M	<p>Life cycle management for your plant</p> <p>W@M supports you with a wide range of software applications over the entire process: from planning and procurement, to the installation, commissioning and operation of the measuring devices. All the relevant information is available for every measuring device over time entire life cycle, such as the Device status, spare parts, device-specific documentation.</p> <p>The application already contains the data of your Endress+Hauser device. Endress+Hauser also takes care of maintaining and updating the data records.</p> <p>W@M is available:</p> <ul style="list-style-type: none"> ■ Via the Internet: www.endress.com/lifecyclemanagement ■ On CD-ROM for local PC installation.
FieldCare	<p>FDT-based plant asset management tool from Endress+Hauser.</p> <p>It can configure all smart field units in your system and helps you manage them. By using the status information, it is also a simple but effective way of checking their status and condition.</p>  For details, see Operating Instructions BA00027S and BA00059S
DeviceCare	<p>Tool for connecting and configuring Endress+Hauser field devices.</p>  For details, see Innovation brochure IN01047S
Commubox FXA291	<p>Connects Endress+Hauser field devices with a CDI interface (= Endress+Hauser Common Data Interface) and the USB port of a computer or laptop.</p>  For details, see "Technical Information" TI00405C

Supplementary documentation



For an overview of the scope of the associated Technical Documentation, refer to the following:

- The *W@M Device Viewer* : Enter the serial number from the nameplate (www.endress.com/deviceviewer)
- The *Endress+Hauser Operations App*: Enter the serial number from the nameplate or scan the 2-D matrix code (QR code) on the nameplate.

Standard documentation

Brief Operating Instructions

Measuring device	Documentation code
Dosimass	KA00043D

Operating Instructions

Measuring device	Documentation code	
	Pulse/frequency/status output Option 3	Modbus RS485 Option 4 and 5
Dosimass	BA00097D	BA01320D

Description of device parameters

Measuring device	Documentation code	
	Pulse/frequency/status output Option 3	Modbus RS485 Option 4 and 5
Dosimass	GP01050D	GP01047D

Supplementary device-dependent documentation

Safety Instructions

Contents	Documentation code
ATEX Ex nA	XA00079D
cCSAus	FES0232

Registered trademarks

Modbus®

Registered trademark of SCHNEIDER AUTOMATION, INC.

TRI-CLAMP®

Registered trademark of Ladish & Co., Inc., Kenosha, USA

Applicator®, FieldCare®, DeviceCare®

Registered or registration-pending trademarks of the Endress+Hauser Group

www.addresses.endress.com
