

# Technical Information

## Proline Promass H 100

Coriolis flowmeter



The chemically resistant single-tube flowmeter with an ultra-compact transmitter

### Application

- Measuring principle operates independently of physical fluid properties such as viscosity or density
- Highly accurate measurement of liquids and gases in applications requiring excellent corrosion resistance

### Device properties

- Measuring tube made of tantalum and zirconium
- Nominal diameter: DN 8 to 50 ( $\frac{3}{8}$  to 2")
- Medium temperature up to +200 °C (+392 °F)
- Robust, ultra-compact transmitter housing
- Highest degree of protection: IP69K
- Local display available

### Your benefits

- Maximum safety for chemically aggressive fluids – corrosion-resistant wetted parts
- Fewer process measuring points – multivariable measurement (flow, density, temperature)
- Space-saving installation – no inlet/outlet run needs
- Space-saving transmitter – full functionality on smallest footprint
- Time-saving local operation without additional software and hardware – integrated web server
- Integrated verification – Heartbeat Technology™

## Table of contents







<b>Document information</b> . . . . .	<b>4</b>	Degree of protection . . . . .	50
Symbols used . . . . .	4	Vibration resistance . . . . .	50
<b>Function and system design</b> . . . . .	<b>5</b>	Shock resistance . . . . .	50
Measuring principle . . . . .	5	Shock resistance . . . . .	50
Measuring system . . . . .	5	Interior cleaning . . . . .	50
Equipment architecture . . . . .	7	Electromagnetic compatibility (EMC) . . . . .	50
Safety . . . . .	7	<b>Process</b> . . . . .	<b>51</b>
<b>Input</b> . . . . .	<b>8</b>	Medium temperature range . . . . .	51
Measured variable . . . . .	8	Density . . . . .	51
Measuring range . . . . .	8	Pressure-temperature ratings . . . . .	51
Operable flow range . . . . .	8	Secondary containment pressure rating . . . . .	52
Input signal . . . . .	9	Flow limit . . . . .	52
<b>Output</b> . . . . .	<b>9</b>	Pressure loss . . . . .	53
Output signal . . . . .	9	System pressure . . . . .	53
Signal on alarm . . . . .	11	Thermal insulation . . . . .	53
Ex connection data . . . . .	12	Heating . . . . .	54
Low flow cut off . . . . .	13	Vibrations . . . . .	54
Galvanic isolation . . . . .	13	<b>Mechanical construction</b> . . . . .	<b>55</b>
Protocol-specific data . . . . .	13	Dimensions in SI units . . . . .	55
<b>Power supply</b> . . . . .	<b>23</b>	Dimensions in US units . . . . .	60
Terminal assignment . . . . .	23	Weight . . . . .	64
Pin assignment, device plug . . . . .	30	Materials . . . . .	65
Supply voltage . . . . .	32	Process connections . . . . .	66
Power consumption . . . . .	33	Surface roughness . . . . .	66
Current consumption . . . . .	33	<b>Operability</b> . . . . .	<b>66</b>
Power supply failure . . . . .	33	Operating concept . . . . .	66
Electrical connection . . . . .	34	Local display . . . . .	67
Potential equalization . . . . .	39	Remote operation . . . . .	67
Terminals . . . . .	39	Service interface . . . . .	69
Cable entries . . . . .	39	<b>Certificates and approvals</b> . . . . .	<b>71</b>
Cable specification . . . . .	39	CE mark . . . . .	71
<b>Performance characteristics</b> . . . . .	<b>41</b>	C-Tick symbol . . . . .	71
Reference operating conditions . . . . .	41	Ex approval . . . . .	72
Maximum measured error . . . . .	41	HART certification . . . . .	72
Repeatability . . . . .	43	Certification PROFIBUS . . . . .	72
Response time . . . . .	43	Certification PROFINET . . . . .	72
Influence of ambient temperature . . . . .	43	EtherNet/IP certification . . . . .	73
Influence of medium temperature . . . . .	43	Modbus RS485 certification . . . . .	73
Influence of medium pressure . . . . .	44	Pressure Equipment Directive . . . . .	73
Design fundamentals . . . . .	44	Other standards and guidelines . . . . .	73
<b>Installation</b> . . . . .	<b>45</b>	<b>Ordering information</b> . . . . .	<b>74</b>
Mounting location . . . . .	45	<b>Application packages</b> . . . . .	<b>74</b>
Orientation . . . . .	46	Heartbeat Technology . . . . .	74
Inlet and outlet runs . . . . .	47	Concentration . . . . .	75
Special mounting instructions . . . . .	47	<b>Accessories</b> . . . . .	<b>75</b>
Mounting Safety Barrier Promass 100 . . . . .	47	Device-specific accessories . . . . .	75
<b>Environment</b> . . . . .	<b>47</b>	Communication-specific accessories . . . . .	75
Ambient temperature range . . . . .	47	Service-specific accessories . . . . .	76
Storage temperature . . . . .	50	System components . . . . .	77
Climate class . . . . .	50		

<b>Supplementary documentation</b> . . . . .	<b>77</b>
Standard documentation . . . . .	77
Supplementary device-dependent documentation . . . . .	77
<b>Registered trademarks</b> . . . . .	<b>78</b>









## Document information

### Symbols used





### Electrical symbols

Symbol	Meaning	Symbol	Meaning
	Direct current		Alternating current
	Direct current and alternating current		<b>Ground connection</b> A grounded terminal which, as far as the operator is concerned, is grounded via a grounding system.
	<b>Protective ground connection</b> A terminal which must be connected to ground prior to establishing any other connections.		<b>Equipotential connection</b> A connection that has to be connected to the plant grounding system: This may be a potential equalization line or a star grounding system depending on national or company codes of practice.

### Symbols for certain types of information

Symbol	Meaning
	<b>Permitted</b> Procedures, processes or actions that are permitted.
	<b>Preferred</b> Procedures, processes or actions that are preferred.
	<b>Forbidden</b> Procedures, processes or actions that are forbidden.
	<b>Tip</b> Indicates additional information.
	Reference to documentation
	Reference to page
	Reference to graphic
	Visual inspection

### Symbols in graphics

Symbol	Meaning	Symbol	Meaning
1, 2, 3,...	Item numbers		Series of steps
A, B, C, ...	Views	A-A, B-B, C-C, ...	Sections
	Hazardous area		Safe area (non-hazardous area)
	Flow direction		

## Function and system design

### Measuring principle

The measuring principle is based on the controlled generation of Coriolis forces. These forces are always present in a system when both translational and rotational movements are superimposed.

$$F_c = 2 \cdot \Delta m (v \cdot \omega)$$

$F_c$  = Coriolis force

$\Delta m$  = moving mass

$\omega$  = rotational velocity

$v$  = radial velocity in rotating or oscillating system

The amplitude of the Coriolis force depends on the moving mass  $\Delta m$ , its velocity  $v$  in the system and thus on the mass flow. Instead of a constant rotational velocity  $\omega$ , the sensor uses oscillation.

In the sensor, an oscillation is produced in the measuring tube. The Coriolis forces produced at the measuring tube cause a phase shift in the tube oscillations (see illustration):

- If there is zero flow (i.e. when the fluid stands still), the oscillation measured at points A and B has the same phase (no phase difference).
- Mass flow causes deceleration of the oscillation at the inlet of the tubes (2) and acceleration at the outlet (3).

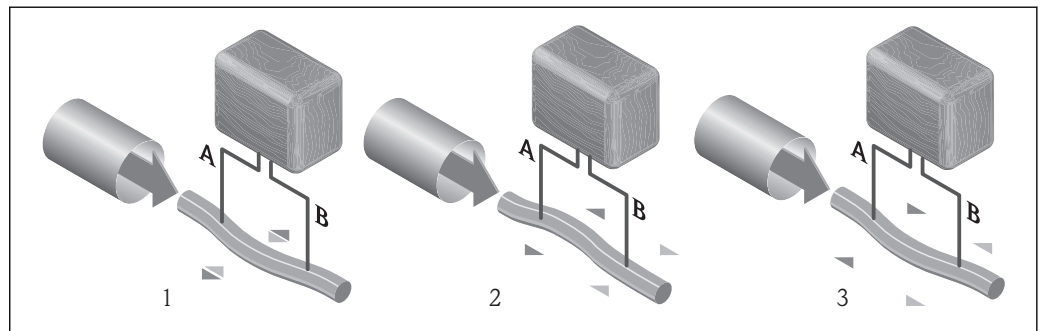

A0016772

The phase difference (A-B) increases with increasing mass flow. Electrodynamical sensors register the tube oscillations at the inlet and outlet. System balance is created by exciting an eccentrically arranged swinging mass to antiphase oscillation. The measuring principle operates independently of temperature, pressure, viscosity, conductivity and flow profile.

#### Density measurement

The measuring tube is continuously excited at its resonance frequency. A change in the mass and thus the density of the oscillating system (comprising measuring tube and fluid) results in a corresponding, automatic adjustment in the oscillation frequency. Resonance frequency is thus a function of medium density. The microprocessor utilizes this relationship to obtain a density signal.

#### Volume measurement

Together with the measured mass flow, this is used to calculate the volume flow.

#### Temperature measurement

The temperature of the measuring tube is determined in order to calculate the compensation factor due to temperature effects. This signal corresponds to the process temperature and is also available as an output signal.

### Measuring system

The device consists of a transmitter and a sensor. If a device with Modbus RS485 intrinsically safe is ordered, the Safety Barrier Promass 100 is part of the scope of supply and must be implemented to operate the device.

The device is available as a compact version:

The transmitter and sensor form a mechanical unit.

## Transmitter

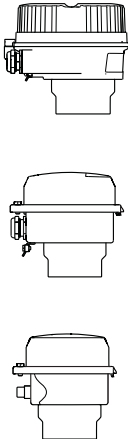
<p><b>Promass 100</b></p>  <p>A0016693</p> <p>A0016694</p> <p>A0016695</p>	<p>Device versions and materials:</p> <ul style="list-style-type: none"> <li>■ Compact, aluminum coated: Aluminum, AlSi10Mg, coated</li> <li>■ Compact, stainless: Stainless steel 1.4301 (304)</li> <li>■ Ultra-compact, stainless: Stainless steel 1.4301 (304)</li> </ul> <p>Configuration:</p> <ul style="list-style-type: none"> <li>■ Via operating tools (e.g. FieldCare)</li> <li>■ Additionally for device version with local display: Via Web browser (e.g. Microsoft Internet Explorer)</li> <li>■ Also for device version with 4-20 mA HART, pulse/frequency/switch output: Via Web browser (e.g. Microsoft Internet Explorer)</li> <li>■ Also for device version with EtherNet/IP output: <ul style="list-style-type: none"> <li>- Via Web browser (e.g. Microsoft Internet Explorer)</li> <li>- Via Add-on Profile Level 3 for automation system from Rockwell Automation</li> <li>- Via Electronic Data Sheet (EDS)</li> </ul> </li> <li>■ Also for device version with PROFINET output: <ul style="list-style-type: none"> <li>- Via Web browser (e.g. Microsoft Internet Explorer)</li> <li>- Via device master file (GSD)</li> </ul> </li> </ul>
---	--

## Sensor

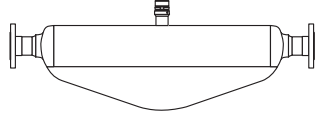
<p><b>Promass H</b></p>  <p>A0019542</p>	<ul style="list-style-type: none"> <li>■ Single bent tube</li> <li>■ Simultaneous measurement of flow, volume flow, density and temperature (multivariable)</li> <li>■ Minimal pressure losses and chemical-resistant materials</li> <li>■ Nominal diameter range: DN 8 to 50 (3/8 to 2")</li> <li>■ Materials: <ul style="list-style-type: none"> <li>- Sensor: stainless steel, 1.4301 (304)</li> <li>- Measuring tubes: zirconium 702 (UNS R60702); tantalum 2.5W</li> <li>- Process connections: stainless steel, 1.4301 (304), wetted parts: zirconium 702 (UNS R60702); tantalum</li> </ul> </li> </ul>
---	---

## Safety Barrier Promass 100

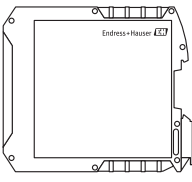
 <p>A0016763</p>	<ul style="list-style-type: none"> <li>■ Dual-channel safety barrier for installation in non-hazardous locations or zone 2/div. 2: <ul style="list-style-type: none"> <li>- Channel 1: DC 24 V power supply</li> <li>- Channel 2: Modbus RS485</li> </ul> </li> <li>■ In addition to current, voltage and power limitation, it offers galvanic isolation of circuits for explosion protection.</li> <li>■ Easy top-hat rail mounting (DIN 35 mm) for installation in control cabinets</li> </ul>
---	--

Equipment architecture

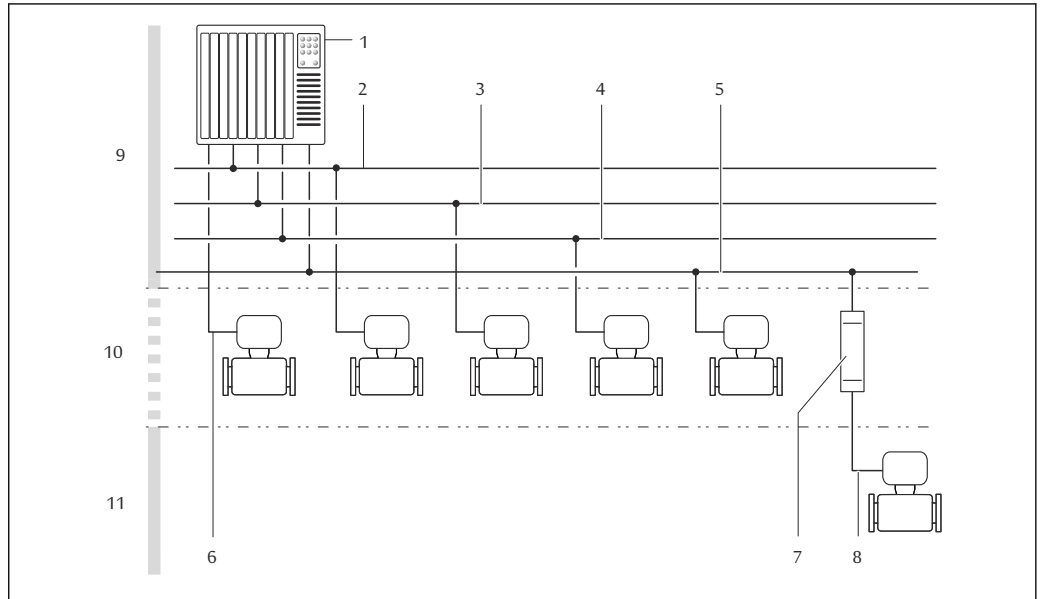

A0016779

1 Possibilities for integrating measuring devices into a system

- 1 Automation system (e.g. PLC)
- 2 EtherNet/IP
- 3 PROFIBUS DP
- 4 Modbus RS485
- 5 4-20 mA HART, pulse/frequency/switch output
- 6 Safety Barrier Promass 100
- 7 Modbus RS485 intrinsically safe
- 8 Non-hazardous area
- 9 Non-hazardous area and Zone 2/Div. 2
- 10 Intrinsically safe area and Zone 1/Div. 1

Safety

IT security

We only provide a warranty if the device is installed and used as described in the Operating Instructions. The device is equipped with security mechanisms to protect it against any inadvertent changes to the device settings.

IT security measures in line with operators' security standards and designed to provide additional protection for the device and device data transfer must be implemented by the operators themselves.

## Input

### Measured variable

#### Direct measured variables

- Mass flow
- Density
- Temperature

#### Calculated measured variables

- Volume flow
- Corrected volume flow
- Reference density

### Measuring range

#### Measuring ranges for liquids

DN		Measuring range full scale values $\dot{m}_{\min(F)}$ to $\dot{m}_{\max(F)}$	
[mm]	[in]	[kg/h]	[lb/min]
8	$\frac{3}{8}$	0 to 2 000	0 to 73.50
15	$\frac{1}{2}$	0 to 6 500	0 to 238.9
25	1	0 to 18 000	0 to 661.5
40	$1\frac{1}{2}$	0 to 45 000	0 to 1 654
50	2	0 to 70 000	0 to 2 573

#### Measuring ranges for gases

Measuring ranges only valid for Promass H with tantalum 2.5W.

The full scale values depend on the density of the gas and can be calculated with the formula below:

$$\dot{m}_{\max(G)} = \dot{m}_{\max(F)} \cdot \rho_G \cdot X$$

$\dot{m}_{\max(G)}$	Maximum full scale value for gas [kg/h]
$\dot{m}_{\max(F)}$	Maximum full scale value for liquid [kg/h]
$\dot{m}_{\max(G)} < \dot{m}_{\max(F)}$	$\dot{m}_{\max(G)}$ can never be greater than $\dot{m}_{\max(F)}$
$\rho_G$	Gas density in [kg/m <sup>3</sup> ] at operating conditions

DN		x
[mm]	[in]	[kg/m <sup>3</sup> ]
8	$\frac{3}{8}$	60
15	$\frac{1}{2}$	80
25	1	90
40	$1\frac{1}{2}$	90
50	2	90



To calculate the measuring range, use the *Applicator* sizing tool → 76

#### Recommended measuring range

"Flow limit" section → 52

### Operable flow range

Over 1000 : 1.

Flow rates above the preset full scale value are not overridden by the electronics unit, with the result that the totalizer values are registered correctly.



**Input signal**

**External measured values**

To increase the accuracy of certain measured variables or to calculate the corrected volume flow for gases, the automation system can continuously write different measured values to the measuring device:

- Operating pressure to increase accuracy (Endress+Hauser recommends the use of a pressure measuring device for absolute pressure, e.g. Cerabar M or Cerabar S)
- Medium temperature to increase accuracy (e.g. iTEMP)
- Reference density for calculating the corrected volume flow for gases

 Various pressure transmitters and temperature measuring devices can be ordered from Endress +Hauser: see "Accessories" section →  77

It is recommended to read in external measured values to calculate the following measured variables:

- Mass flow
- Corrected volume flow

*HART protocol*

The measured values are written from the automation system to the measuring device via the HART protocol. The pressure transmitter must support the following protocol-specific functions:

- HART protocol
- Burst mode

*Digital communication*

The measured values can be written from the automation system to the measuring via:

- PROFIBUS DP
- Modbus RS485
- EtherNet/IP
- PROFINET

## Output



**Output signal**

**Current output**

<b>Current output</b>	4-20 mA HART (active)
<b>Maximum output values</b>	<ul style="list-style-type: none"> <li>■ DC 24 V (no flow)</li> <li>■ 22.5 mA</li> </ul>
<b>Load</b>	0 to 700 Ω
<b>Resolution</b>	0.38 µA
<b>Damping</b>	Adjustable: 0.07 to 999 s
<b>Assignable measured variables</b>	<ul style="list-style-type: none"> <li>■ Mass flow</li> <li>■ Volume flow</li> <li>■ Corrected volume flow</li> <li>■ Density</li> <li>■ Reference density</li> <li>■ Temperature</li> </ul> <p> The range of options increases if the measuring device has one or more application packages.</p>

**Pulse/frequency/switch output**

<b>Function</b>	Can be set to pulse, frequency or switch output
<b>Version</b>	Passive, open collector
<b>Maximum input values</b>	<ul style="list-style-type: none"> <li>■ DC 30 V</li> <li>■ 25 mA</li> </ul>
<b>Voltage drop</b>	For 25 mA: ≤ DC 2 V
<b>Pulse output</b>	

<b>Pulse width</b>	Adjustable: 0.05 to 2 000 ms
<b>Maximum pulse rate</b>	10 000 Impulse/s
<b>Pulse value</b>	Adjustable
<b>Assignable measured variables</b>	<ul style="list-style-type: none"> <li>■ Mass flow</li> <li>■ Volume flow</li> <li>■ Corrected volume flow</li> </ul>
<b>Frequency output</b>	
<b>Output frequency</b>	Adjustable: 0 to 10 000 Hz
<b>Damping</b>	Adjustable: 0 to 999 s
<b>Pulse/pause ratio</b>	1:1
<b>Assignable measured variables</b>	<ul style="list-style-type: none"> <li>■ Mass flow</li> <li>■ Volume flow</li> <li>■ Corrected volume flow</li> <li>■ Density</li> <li>■ Reference density</li> <li>■ Temperature</li> </ul> <p> The range of options increases if the measuring device has one or more application packages.</p>
<b>Switch output</b>	
<b>Switching behavior</b>	Binary, conductive or non-conductive
<b>Switching delay</b>	Adjustable: 0 to 100 s
<b>Number of switching cycles</b>	Unlimited
<b>Assignable functions</b>	<ul style="list-style-type: none"> <li>■ Off</li> <li>■ On</li> <li>■ Diagnostic behavior</li> <li>■ Limit value <ul style="list-style-type: none"> <li>- Mass flow</li> <li>- Volume flow</li> <li>- Corrected volume flow</li> <li>- Density</li> <li>- Reference density</li> <li>- Temperature</li> <li>- Totalizer 1-3</li> </ul> </li> <li>■ Flow direction monitoring</li> <li>■ Status <ul style="list-style-type: none"> <li>- Partially filled pipe detection</li> <li>- Low flow cut off</li> </ul> </li> </ul> <p> The range of options increases if the measuring device has one or more application packages.</p>

**PROFIBUS DP**

<b>Signal encoding</b>	NRZ code
<b>Data transfer</b>	9.6 kBaud...12 MBaud

**Modbus RS485**

<b>Physical interface</b>	In accordance with EIA/TIA-485-A standard
<b>Terminating resistor</b>	<ul style="list-style-type: none"> <li>■ For device version used in non-hazardous areas or Zone 2/Div. 2: integrated and can be activated via DIP switches on the transmitter electronics module</li> <li>■ For device version used in intrinsically safe areas: integrated and can be activated via DIP switches on the Safety Barrier Promass 100</li> </ul>

**EtherNet/IP**

<b>Standards</b>	In accordance with IEEE 802.3
------------------	-------------------------------

**PROFINET**

<b>Standards</b>	In accordance with IEEE 802.3
------------------	-------------------------------

**Signal on alarm**

Depending on the interface, failure information is displayed as follows:

**Current output**

4-20 mA

<b>Failure mode</b>	Choose from: <ul style="list-style-type: none"> <li>▪ 4 to 20 mA in accordance with NAMUR recommendation NE 43</li> <li>▪ 4 to 20 mA in accordance with US</li> <li>▪ Min. value: 3.59 mA</li> <li>▪ Max. value: 22.5 mA</li> <li>▪ Freely definable value between: 3.59 to 22.5 mA</li> <li>▪ Actual value</li> <li>▪ Last valid value</li> </ul>
---------------------	--

*HART*

<b>Device diagnostics</b>	Device condition can be read out via HART Command 48
---------------------------	--

**Pulse/frequency/switch output**

<b>Pulse output</b>	
<b>Failure mode</b>	Choose from: <ul style="list-style-type: none"> <li>▪ Actual value</li> <li>▪ No pulses</li> </ul>
<b>Frequency output</b>	
<b>Failure mode</b>	Choose from: <ul style="list-style-type: none"> <li>▪ Actual value</li> <li>▪ 0 Hz</li> <li>▪ Defined value: 0 to 12 500 Hz</li> </ul>
<b>Switch output</b>	
<b>Failure mode</b>	Choose from: <ul style="list-style-type: none"> <li>▪ Current status</li> <li>▪ Open</li> <li>▪ Closed</li> </ul>

**PROFIBUS DP**

<b>Status and alarm messages</b>	Diagnostics in accordance with PROFIBUS PA Profile 3.02
----------------------------------	---

**Modbus RS485**

<b>Failure mode</b>	Choose from: <ul style="list-style-type: none"> <li>▪ NaN value instead of current value</li> <li>▪ Last valid value</li> </ul>
---------------------	---

**EtherNet/IP**

<b>Device diagnostics</b>	Device condition can be read out in Input Assembly
---------------------------	--

**PROFINET**

<b>Device diagnostics</b>	In accordance with "Application Layer protocol for decentral device periphery and distributed automation", version 2.3
---------------------------	--

**Local display**

<b>Plain text display</b>	With information on cause and remedial measures
<b>Backlight</b>	Red backlighting indicates a device error.



Status signal as per NAMUR recommendation NE 107

**Operating tool**

- Via digital communication:
  - HART protocol
  - PROFIBUS DP
  - Modbus RS485
  - EtherNet/IP
  - PROFINET
- Via service interface
- Via Web server

<b>Plain text display</b>	With information on cause and remedial measures
---------------------------	---



Additional information on remote operation → 67

**Web browser**

<b>Plain text display</b>	With information on cause and remedial measures
---------------------------	---

**Light emitting diodes (LED)**

<b>Status information</b>	<p>Status indicated by various light emitting diodes</p> <p>The following information is displayed depending on the device version:</p> <ul style="list-style-type: none"> <li>■ Supply voltage active</li> <li>■ Data transmission active</li> <li>■ Device alarm/error has occurred</li> <li>■ EtherNet/IP network available</li> <li>■ EtherNet/IP connection established</li> <li>■ PROFINET network available</li> <li>■ PROFINET connection established</li> <li>■ PROFINET blinking feature</li> </ul>
---------------------------	---

**Ex connection data**

These values only apply for the following device version:  
Order code for "Output", option M "Modbus RS485", for use in intrinsically safe areas

**Safety Barrier Promass 100**

*Safety-related values*

Terminal numbers			
Supply voltage		Signal transmission	
2 (L-)	1 (L+)	26 (A)	27 (B)
$U_{nom} = DC\ 24\ V$ $U_{max} = AC\ 260\ V$		$U_{nom} = DC\ 5\ V$ $U_{max} = AC\ 260\ V$	

*Intrinsically safe values*

Terminal numbers			
Supply voltage		Signal transmission	
20 (L-)	10 (L+)	62 (A)	72 (B)
$U_o = 16.24\ V$ $I_o = 623\ mA$ $P_o = 2.45\ W$ With IIC <sup>1)</sup> : $L_o = 92.8\ \mu H$ , $C_o = 0.433\ \mu F$ , $L_o/R_o = 14.6\ \mu H/\Omega$ With IIB <sup>1)</sup> : $L_o = 372\ \mu H$ , $C_o = 2.57\ \mu F$ , $L_o/R_o = 58.3\ \mu H/\Omega$			
 For an overview and for information on the interdependencies between the gas group - sensor - nominal diameter, see the "Safety Instructions" (XA) document for the measuring device			

1) The gas group depends on the sensor and nominal diameter.

**Transmitter**

*Intrinsically safe values*

Order code for "Approval"	Terminal numbers			
	Supply voltage		Signal transmission	
	20 (L-)	10 (L+)	62 (A)	72 (B)
<ul style="list-style-type: none"> <li>▪ Option <b>BM</b>: ATEX II2G + IECEx Z1 Ex ia, II2D Ex tb</li> <li>▪ Option <b>BO</b>: ATEX II1/2G + IECEx Z0/Z1 Ex ia, II2D</li> <li>▪ Option <b>BQ</b>: ATEX II1/2G + IECEx Z0/Z1 Ex ia</li> <li>▪ Option <b>BU</b>: ATEX II2G + IECEx Z1 Ex ia</li> <li>▪ Option <b>C2</b>: CSA C/US IS Cl. I, II, III Div. 1</li> <li>▪ Option <b>85</b>: ATEX II2G + IECEx Z1 Ex ia + CSA C/US IS Cl. I, II, III Div. 1</li> </ul>	$U_i = 16.24\ V$ $I_i = 623\ mA$ $P_i = 2.45\ W$ $L_i = 0\ \mu H$ $C_i = 6\ nF$			
 For an overview and for information on the interdependencies between the gas group - sensor - nominal diameter, see the "Safety Instructions" (XA) document for the measuring device				

**Low flow cut off**

The switch points for low flow cut off are user-selectable.

**Galvanic isolation**

The following connections are galvanically isolated from each other:

- Outputs
- Power supply

**Protocol-specific data**

**HART**

Manufacturer ID	0x11
Device type ID	0x4A
HART protocol revision	7
Device description files (DTM, DD)	Information and files under: <a href="http://www.endress.com">www.endress.com</a>
HART load	Min. 250 $\Omega$

<b>Dynamic variables</b>	<p>Read out the dynamic variables: HART command 3 The measured variables can be freely assigned to the dynamic variables.</p> <p><b>Measured variables for PV (primary dynamic variable)</b></p> <ul style="list-style-type: none"> <li>▪ Mass flow</li> <li>▪ Volume flow</li> <li>▪ Corrected volume flow</li> <li>▪ Density</li> <li>▪ Reference density</li> <li>▪ Temperature</li> </ul> <p><b>Measured variables for SV, TV, QV (secondary, tertiary and quaternary dynamic variable)</b></p> <ul style="list-style-type: none"> <li>▪ Mass flow</li> <li>▪ Volume flow</li> <li>▪ Corrected volume flow</li> <li>▪ Density</li> <li>▪ Reference density</li> <li>▪ Temperature</li> <li>▪ Totalizer 1</li> <li>▪ Totalizer 2</li> <li>▪ Totalizer 3</li> </ul> <p> The range of options increases if the measuring device has one or more application packages.</p> <p><b>Heartbeat Technology Application Package</b> Additional measured variables are available with the Heartbeat Technology application package:</p> <ul style="list-style-type: none"> <li>▪ Carrier pipe temperature</li> <li>▪ Oscillation amplitude 0</li> </ul>
<b>Device variables</b>	<p>Read out the device variables: HART command 9 The device variables are permanently assigned.</p> <p>A maximum of 8 device variables can be transmitted:</p> <ul style="list-style-type: none"> <li>▪ 0 = mass flow</li> <li>▪ 1 = volume flow</li> <li>▪ 2 = corrected volume flow</li> <li>▪ 3 = density</li> <li>▪ 4 = reference density</li> <li>▪ 5 = temperature</li> <li>▪ 6 = totalizer 1</li> <li>▪ 7 = totalizer 2</li> <li>▪ 8 = totalizer 3</li> <li>▪ 13 = target mass flow</li> <li>▪ 14 = carrier mass flow</li> <li>▪ 15 = concentration</li> </ul>

**PROFIBUS DP**

<b>Manufacturer ID</b>	0x11
<b>Ident number</b>	0x1561
<b>Profile version</b>	3.02
<b>Device description files (GSD, DTM, DD)</b>	<p>Information and files under:</p> <ul style="list-style-type: none"> <li>▪ <a href="http://www.endress.com">www.endress.com</a> On the product page for the device: Documents/Software → Device drivers</li> <li>▪ <a href="http://www.profibus.org">www.profibus.org</a></li> </ul>

<p><b>Output values</b> (from measuring device to automation system)</p>	<p><b>Analog input 1 to 8</b></p> <ul style="list-style-type: none"> <li>▪ Mass flow</li> <li>▪ Volume flow</li> <li>▪ Corrected volume flow</li> <li>▪ Target mass flow</li> <li>▪ Carrier mass flow</li> <li>▪ Density</li> <li>▪ Reference density</li> <li>▪ Concentration</li> <li>▪ Temperature</li> <li>▪ Carrier pipe temperature</li> <li>▪ Electronic temperature</li> <li>▪ Oscillation frequency</li> <li>▪ Oscillation amplitude</li> <li>▪ Frequency fluctuation</li> <li>▪ Oscillation damping</li> <li>▪ Tube damping fluctuation</li> <li>▪ Signal asymmetry</li> <li>▪ Exciter current</li> </ul> <p><b>Digital input 1 to 2</b></p> <ul style="list-style-type: none"> <li>▪ Partially filled pipe detection</li> <li>▪ Low flow cut off</li> </ul> <p><b>Totalizer 1 to 3</b></p> <ul style="list-style-type: none"> <li>▪ Mass flow</li> <li>▪ Volume flow</li> <li>▪ Corrected volume flow</li> </ul>
<p><b>Input values</b> (from automation system to measuring device)</p>	<p><b>Analog output 1 to 3 (fixed assignment)</b></p> <ul style="list-style-type: none"> <li>▪ Pressure</li> <li>▪ Temperature</li> <li>▪ Reference density</li> </ul> <p><b>Digital output 1 to 3 (fixed assignment)</b></p> <ul style="list-style-type: none"> <li>▪ Digital output 1: switch positive zero return on/off</li> <li>▪ Digital output 2: perform zero point adjustment</li> <li>▪ Digital output 3: switch switch output on/off</li> </ul> <p><b>Totalizer 1 to 3</b></p> <ul style="list-style-type: none"> <li>▪ Totalize</li> <li>▪ Reset and hold</li> <li>▪ Preset and hold</li> <li>▪ Stop</li> <li>▪ Operating mode configuration: <ul style="list-style-type: none"> <li>– Net flow total</li> <li>– Forward flow total</li> <li>– Reverse flow total</li> </ul> </li> </ul>
<p><b>Supported functions</b></p>	<ul style="list-style-type: none"> <li>▪ Identification &amp; Maintenance Simplest device identification on the part of the control system and nameplate</li> <li>▪ PROFIBUS upload/download Reading and writing parameters is up to ten times faster with PROFIBUS upload/download</li> <li>▪ Condensed status Simplest and self-explanatory diagnostic information by categorizing diagnostic messages that occur</li> </ul>
<p><b>Configuration of the device address</b></p>	<ul style="list-style-type: none"> <li>▪ DIP switches on the I/O electronics module</li> <li>▪ Via operating tools (e.g. FieldCare)</li> </ul>

**Modbus RS485**

<p><b>Protocol</b></p>	<p>Modbus Applications Protocol Specification V1.1</p>
<p><b>Device type</b></p>	<p>Slave</p>
<p><b>Slave address range</b></p>	<p>1 to 247</p>
<p><b>Broadcast address range</b></p>	<p>0</p>

<b>Function codes</b>	<ul style="list-style-type: none"> <li>▪ 03: Read holding register</li> <li>▪ 04: Read input register</li> <li>▪ 06: Write single registers</li> <li>▪ 08: Diagnostics</li> <li>▪ 16: Write multiple registers</li> <li>▪ 23: Read/write multiple registers</li> </ul>
<b>Broadcast messages</b>	Supported by the following function codes: <ul style="list-style-type: none"> <li>▪ 06: Write single registers</li> <li>▪ 16: Write multiple registers</li> <li>▪ 23: Read/write multiple registers</li> </ul>
<b>Supported baud rate</b>	<ul style="list-style-type: none"> <li>▪ 1 200 BAUD</li> <li>▪ 2 400 BAUD</li> <li>▪ 4 800 BAUD</li> <li>▪ 9 600 BAUD</li> <li>▪ 19 200 BAUD</li> <li>▪ 38 400 BAUD</li> <li>▪ 57 600 BAUD</li> <li>▪ 115 200 BAUD</li> </ul>
<b>Data transfer mode</b>	<ul style="list-style-type: none"> <li>▪ ASCII</li> <li>▪ RTU</li> </ul>
<b>Data access</b>	Each device parameter can be accessed via Modbus RS485.  For Modbus register information

### EtherNet/IP

<b>Protocol</b>	<ul style="list-style-type: none"> <li>▪ The CIP Networks Library Volume 1: Common Industrial Protocol</li> <li>▪ The CIP Networks Library Volume 2: EtherNet/IP Adaptation of CIP</li> </ul>
<b>Communication type</b>	<ul style="list-style-type: none"> <li>▪ 10Base-T</li> <li>▪ 100Base-TX</li> </ul>
<b>Device profile</b>	Generic device (product type: 0x2B)
<b>Manufacturer ID</b>	0x49E
<b>Device type ID</b>	0x104A
<b>Baud rates</b>	Automatic <sup>10</sup> / <sub>100</sub> Mbit with half-duplex and full-duplex detection
<b>Polarity</b>	Auto-polarity for automatic correction of crossed TxD and RxD pairs
<b>Supported CIP connections</b>	Max. 3 connections
<b>Explicit connections</b>	Max. 6 connections
<b>I/O connections</b>	Max. 6 connections (scanner)
<b>Configuration options for measuring device</b>	<ul style="list-style-type: none"> <li>▪ DIP switches on the electronics module for IP addressing</li> <li>▪ Manufacturer-specific software (FieldCare)</li> <li>▪ Add-on Profile Level 3 for Rockwell Automation control systems</li> <li>▪ Web browser</li> <li>▪ Electronic Data Sheet (EDS) integrated in the measuring device</li> </ul>
<b>Configuration of the EtherNet interface</b>	<ul style="list-style-type: none"> <li>▪ Speed: 10 MBit, 100 MBit, auto (factory setting)</li> <li>▪ Duplex: half-duplex, full-duplex, auto (factory setting)</li> </ul>
<b>Configuration of the device address</b>	<ul style="list-style-type: none"> <li>▪ DIP switches on the electronics module for IP addressing (last octet)</li> <li>▪ DHCP</li> <li>▪ Manufacturer-specific software (FieldCare)</li> <li>▪ Add-on Profile Level 3 for Rockwell Automation control systems</li> <li>▪ Web browser</li> <li>▪ EtherNet/IP tools, e.g. RSLinx (Rockwell Automation)</li> </ul>
<b>Device Level Ring (DLR)</b>	No





<b>Fix Input</b>			
<b>RPI</b>	5 ms to 10 s (factory setting: 20 ms)		
<b>Exclusive Owner Multicast</b>		<b>Instance</b>	<b>Size [byte]</b>
	Instance configuration:	0x68	398
	O → T configuration:	0x66	64
	T → O configuration:	0x64	44
<b>Exclusive Owner Multicast</b>		<b>Instance</b>	<b>Size [byte]</b>
	Instance configuration:	0x69	-
	O → T configuration:	0x66	64
	T → O configuration:	0x64	44
<b>Input only Multicast</b>		<b>Instance</b>	<b>Size [byte]</b>
	Instance configuration:	0x68	398
	O → T configuration:	0xC7	-
	T → O configuration:	0x64	44
<b>Input only Multicast</b>		<b>Instance</b>	<b>Size [byte]</b>
	Instance configuration:	0x69	-
	O → T configuration:	0xC7	-
	T → O configuration:	0x64	44
<b>Input Assembly</b>	<ul style="list-style-type: none"> <li>▪ Current device diagnostics</li> <li>▪ Mass flow</li> <li>▪ Volume flow</li> <li>▪ Corrected volume flow</li> <li>▪ Density</li> <li>▪ Reference density</li> <li>▪ Temperature</li> <li>▪ Totalizer 1</li> <li>▪ Totalizer 2</li> <li>▪ Totalizer 3</li> </ul>		
<b>Configurable Input</b>			
<b>RPI</b>	5 ms to 10 s (factory setting: 20 ms)		
<b>Exclusive Owner Multicast</b>		<b>Instance</b>	<b>Size [byte]</b>
	Instance configuration:	0x68	398
	O → T configuration:	0x66	64
	T → O configuration:	0x65	88
<b>Exclusive Owner Multicast</b>		<b>Instance</b>	<b>Size [byte]</b>
	Instance configuration:	0x69	-
	O → T configuration:	0x66	64
	T → O configuration:	0x65	88
<b>Input only Multicast</b>		<b>Instance</b>	<b>Size [byte]</b>
	Instance configuration:	0x68	398
	O → T configuration:	0xC7	-
	T → O configuration:	0x65	88
<b>Input only Multicast</b>		<b>Instance</b>	<b>Size [byte]</b>
	Instance configuration:	0x69	-
	O → T configuration:	0xC7	-
	T → O configuration:	0x65	88

<b>Configurable Input Assembly</b>	<ul style="list-style-type: none"> <li>▪ Current device diagnostics</li> <li>▪ Mass flow</li> <li>▪ Volume flow</li> <li>▪ Corrected volume flow</li> <li>▪ Density</li> <li>▪ Reference density</li> <li>▪ Temperature</li> <li>▪ Totalizer 1</li> <li>▪ Totalizer 2</li> <li>▪ Totalizer 3</li> </ul> <p> The range of options increases if the measuring device has one or more application packages.</p>
<b>Fix Output</b>	
<b>Output Assembly</b>	<ul style="list-style-type: none"> <li>▪ Activation of reset totalizers 1-3</li> <li>▪ Activation of pressure compensation</li> <li>▪ Activation of reference density compensation</li> <li>▪ Activation of temperature compensation</li> <li>▪ Reset totalizers 1-3</li> <li>▪ External pressure value</li> <li>▪ Pressure unit</li> <li>▪ External reference density</li> <li>▪ Reference density unit</li> <li>▪ External temperature</li> <li>▪ Temperature unit</li> </ul>
<b>Configuration</b>	
<b>Configuration Assembly</b>	<p>Only the most common configurations are listed below.</p> <ul style="list-style-type: none"> <li>▪ Software write protection</li> <li>▪ Mass flow unit</li> <li>▪ Mass unit</li> <li>▪ Volume flow unit</li> <li>▪ Volume unit</li> <li>▪ Corrected volume flow unit</li> <li>▪ Corrected volume unit</li> <li>▪ Density unit</li> <li>▪ Reference density unit</li> <li>▪ Temperature unit</li> <li>▪ Pressure unit</li> <li>▪ Length</li> <li>▪ Totalizer 1-3: <ul style="list-style-type: none"> <li>- Assignment</li> <li>- Unit</li> <li>- Measuring mode</li> <li>- Failsafe mode</li> </ul> </li> <li>▪ Alarm delay</li> </ul>

**PROFINET**

<b>Protocol</b>	"Application layer protocol for decentral device periphery and distributed automation", version 2.3
<b>Conformity class</b>	B
<b>Communication type</b>	100 MBit/s
<b>Device profile</b>	Application interface identifier 0xF600 Generic device
<b>Manufacturer ID</b>	0x11
<b>Device type ID</b>	0x844A
<b>Device description files (GSD, DTM)</b>	Information and files under: <ul style="list-style-type: none"> <li>▪ <a href="http://www.endress.com">www.endress.com</a> On the product page for the device: Documents/Software → Device drivers</li> <li>▪ <a href="http://www.profibus.org">www.profibus.org</a></li> </ul>
<b>Baud rates</b>	Automatic 100 Mbit/s with full-duplex detection

<b>Cycle times</b>	From 8 ms
<b>Polarity</b>	Auto-polarity for automatic correction of crossed TxD and RxD pairs
<b>Supported connections</b>	<ul style="list-style-type: none"> <li>▪ 1 x AR (Application Relation)</li> <li>▪ 1 x Input CR (Communication Relation)</li> <li>▪ 1 x Output CR (Communication Relation)</li> <li>▪ 1 x Alarm CR (Communication Relation)</li> </ul>
<b>Configuration options for measuring device</b>	<ul style="list-style-type: none"> <li>▪ DIP switches on the electronics module, for device name assignment (last part)</li> <li>▪ Manufacturer-specific software (FieldCare, DeviceCare)</li> <li>▪ Web browser</li> <li>▪ Device master file (GSD), can be read out via the integrated Web server of the measuring device</li> </ul>
<b>Configuration of the device name</b>	<ul style="list-style-type: none"> <li>▪ DIP switches on the electronics module, for device name assignment (last part)</li> <li>▪ DCP protocol</li> </ul>
<b>Output values</b> (from measuring device to automation system)	<p><b>Analog Input module (slot 1 to 14)</b></p> <ul style="list-style-type: none"> <li>▪ Mass flow</li> <li>▪ Volume flow</li> <li>▪ Corrected volume flow</li> <li>▪ Target mass flow</li> <li>▪ Carrier mass flow</li> <li>▪ Density</li> <li>▪ Reference density</li> <li>▪ Concentration</li> <li>▪ Temperature</li> <li>▪ Carrier pipe temperature</li> <li>▪ Electronic temperature</li> <li>▪ Oscillation frequency</li> <li>▪ Oscillation amplitude</li> <li>▪ Frequency fluctuation</li> <li>▪ Oscillation damping</li> <li>▪ Tube damping fluctuation</li> <li>▪ Signal asymmetry</li> <li>▪ Exciter current</li> </ul> <p><b>Discrete Input module (slot 1 to 14)</b></p> <ul style="list-style-type: none"> <li>▪ Empty pipe detection</li> <li>▪ Low flow cut off</li> </ul> <p><b>Diagnostics Input module (slot 1 to 14)</b></p> <ul style="list-style-type: none"> <li>▪ Last diagnostics</li> <li>▪ Current diagnosis</li> </ul> <p><b>Totalizer 1 to 3 (slot 15 to 17)</b></p> <ul style="list-style-type: none"> <li>▪ Mass flow</li> <li>▪ Volume flow</li> <li>▪ Corrected volume flow</li> </ul> <p><b>Heartbeat Verification module (fixed assignment)</b> Verification status (slot 23)</p> <p> The range of options increases if the measuring device has one or more application packages.</p>

<p><b>Input values</b> (from automation system to measuring device)</p>	<p><b>Analog Output module (fixed assignment)</b></p> <ul style="list-style-type: none"> <li>▪ External pressure (slot 18)</li> <li>▪ External temperature (slot 19)</li> <li>▪ External reference density (slot 20)</li> </ul> <p><b>Discrete Output module (fixed assignment)</b></p> <ul style="list-style-type: none"> <li>▪ Activate/deactivate positive zero return (slot 21)</li> <li>▪ Perform zero point adjustment (slot 22)</li> </ul> <p><b>Totalizer 1 to 3 (slot 15 to 17)</b></p> <ul style="list-style-type: none"> <li>▪ Totalize</li> <li>▪ Reset and hold</li> <li>▪ Preset and hold</li> <li>▪ Stop</li> <li>▪ Operating mode configuration: <ul style="list-style-type: none"> <li>- Net flow total</li> <li>- Forward flow total</li> <li>- Reverse flow total</li> </ul> </li> </ul> <p><b>Heartbeat Verification module (fixed assignment)</b> Start verification (slot 23)</p> <p> The range of options increases if the measuring device has one or more application packages.</p>
<p><b>Supported functions</b></p>	<ul style="list-style-type: none"> <li>▪ Identification &amp; Maintenance Simple device identification via: <ul style="list-style-type: none"> <li>- Control system</li> <li>- Nameplate</li> </ul> </li> <li>▪ Measured value status The process variables are communicated with a measured value status</li> <li>▪ Blinking feature via the onsite display for simple device identification and assignment</li> </ul>

#### Administration of software options

Input/output value	Process variable	Category	Slot
Output value	Mass flow	Process variable	1...14
	Volume flow		
	Corrected volume flow		
	Density		
	Reference density		
	Temperature		
	Electronic temperature		
	Oscillation frequency		
	Frequency fluctuation		
	Oscillation damping		
	Oscillation frequency		
	Signal asymmetry		
	Exciter current		
	Empty pipe detection		
	Low flow cut off		
Output value	Target mass flow	Concentration <sup>1)</sup>	1...14
	Carrier mass flow		
	Concentration		
Output value	Carrier pipe temperature	Heartbeat <sup>2)</sup>	1...14

Input/output value	Process variable	Category	Slot
	Oscillation damping 1		
	Oscillation frequency 1		
	Oscillation amplitude 0		
	Oscillation amplitude 1		
	Frequency fluctuation 1		
	Tube damping fluctuation 1		
	Exciter current 1		
Input value	External density	Process monitoring	18
	External temperature		19
	External reference density		20
	Flow override		21
	Zero point adjustment		22
	Verification status	Heartbeat Verification <sup>2)</sup>	23

- 1) Only available with the "Concentration" application package.
- 2) Only available with the "Heartbeat" application package.

*Startup configuration*

Startup configuration (NSU)	<p>If startup configuration is enabled, the configuration of the most important device parameters is taken from the automation system and used.</p> <p>The following configuration is taken from the automation system:</p> <ul style="list-style-type: none"> <li>■ Management <ul style="list-style-type: none"> <li>- Software revision</li> <li>- Write protection</li> </ul> </li> <li>■ System units <ul style="list-style-type: none"> <li>- Mass flow</li> <li>- Mass</li> <li>- Volume flow</li> <li>- Volume</li> <li>- Corrected volume flow</li> <li>- Corrected volume</li> <li>- Density</li> <li>- Reference density</li> <li>- Temperature</li> <li>- Pressure</li> </ul> </li> <li>■ Concentration application package <ul style="list-style-type: none"> <li>- Coefficients A0 to A4</li> <li>- Coefficients B1 to B3</li> </ul> </li> <li>■ Sensor adjustment</li> <li>■ Process param. <ul style="list-style-type: none"> <li>- Damping (flow, density, temperature)</li> <li>- Flow override</li> </ul> </li> <li>■ Low flow cut off <ul style="list-style-type: none"> <li>- Assign process variable</li> <li>- Switch-on/switch-off point</li> <li>- Pressure shock suppression</li> </ul> </li> <li>■ Empty pipe detection <ul style="list-style-type: none"> <li>- Assign process variable</li> <li>- Limit values</li> <li>- Response time</li> <li>- Max. damping</li> </ul> </li> <li>■ Corrected volume flow calculation <ul style="list-style-type: none"> <li>- External reference density</li> <li>- Fixed reference density</li> <li>- Reference temperature</li> <li>- Linear expansion coefficient</li> <li>- Square expansion coefficient</li> </ul> </li> <li>■ Measuring mode <ul style="list-style-type: none"> <li>- Medium</li> <li>- Gas type</li> <li>- Reference sound velocity</li> <li>- Temperature coefficient sound velocity</li> </ul> </li> <li>■ External compensation <ul style="list-style-type: none"> <li>- Pressure compensation</li> <li>- Pressure value</li> <li>- External pressure</li> </ul> </li> <li>■ Diagnostic settings</li> <li>■ Diagnostic behavior for diverse diagnostic information</li> </ul>
-----------------------------	--

# Power supply

Terminal assignment

Overview: housing version and connection versions

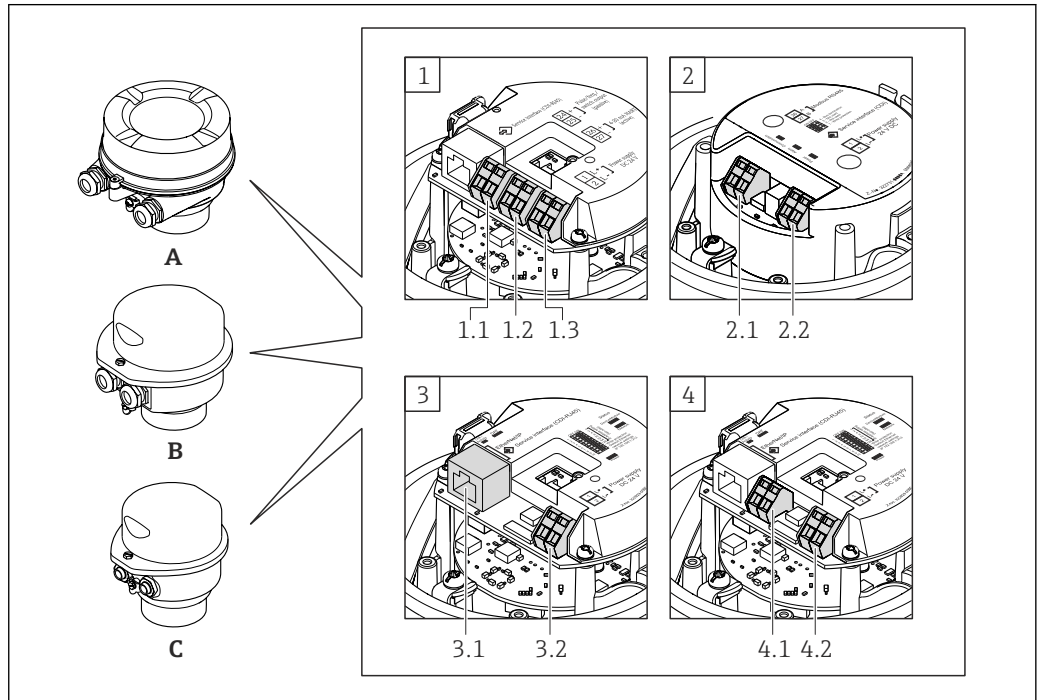

A0016770

- A Housing version: compact, aluminum coated
- B Housing version: compact, stainless
- C Housing version: ultra-compact, stainless
- 1 Connection version: 4-20 mA HART, pulse/frequency/switch output
  - 1.1 Signal transmission: pulse/frequency/switch output
  - 1.2 Signal transmission: 4-20 mA HART
  - 1.3 Supply voltage
- 2 Connection version: Modbus RS485
  - 2.1 Signal transmission
  - 2.2 Supply voltage
- 3 Connection version: EtherNet/IP and PROFINET
  - 3.1 Signal transmission
  - 3.2 Supply voltage
- 4 Connection version: PROFIBUS DP
  - 4.1 Signal transmission
  - 4.2 Supply voltage

**Transmitter**

Connection version 4-20 mA HART with pulse/frequency/switch output

Order code for "Output", option **B**

Depending on the housing version, the transmitters can be ordered with terminals or device plugs.

Order code for "Housing"	Connection methods available		Possible options for order code "Electrical connection"
	Outputs	Power supply	
Options A, B	Terminals	Terminals	<ul style="list-style-type: none"> <li>■ Option A: coupling M20x1</li> <li>■ Option B: thread M20x1</li> <li>■ Option C: thread G ½"</li> <li>■ Option D: thread NPT ½"</li> </ul>
Options A, B	Device plugs → ☰ 30	Terminals	<ul style="list-style-type: none"> <li>■ Option L: plug M12x1 + thread NPT ½"</li> <li>■ Option N: plug M12x1 + coupling M20</li> <li>■ Option P: plug M12x1 + thread G ½"</li> <li>■ Option U: plug M12x1 + thread M20</li> </ul>
Options A, B, C	Device plugs → ☰ 30	Device plugs → ☰ 30	Option Q: 2 x plug M12x1
Order code for "Housing": <ul style="list-style-type: none"> <li>■ Option A: compact, coated aluminum</li> <li>■ Option B: compact, stainless</li> <li>■ Option C: ultra-compact, stainless</li> </ul>			

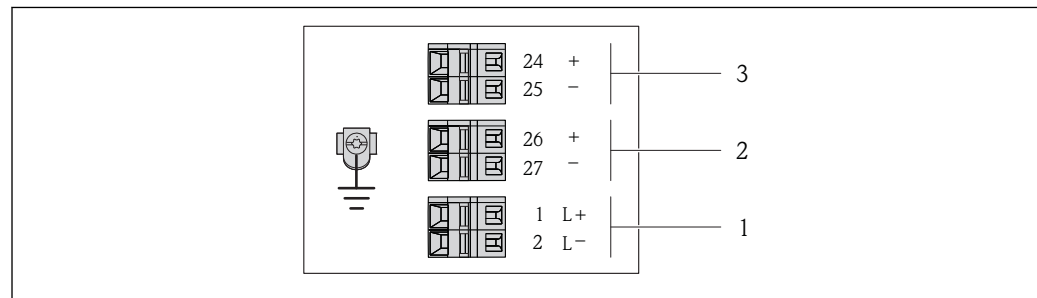

A001688B

☒ 2 Terminal assignment 4-20 mA HART with pulse/frequency/switch output

- 1 Power supply: DC 24 V
- 2 Output 1: 4-20 mA HART (active)
- 3 Output 2: pulse/frequency/switch output (passive)

Order code for "Output"	Terminal number					
	Power supply		Output 1		Output 2	
	2 (L-)	1 (L+)	27 (-)	26 (+)	25 (-)	24 (+)
Option B	DC 24 V		4-20 mA HART (active)		Pulse/frequency/switch output (passive)	
Order code for "Output": Option B: 4-20 mA HART with pulse/frequency/switch output						





PROFIBUS DP connection version

 For use in the non-hazardous area and Zone 2/Div. 2.

Order code for "Output", option **L**

Depending on the housing version, the transmitters can be ordered with terminals or device plugs.

Order code for "Housing"	Connection methods available		Possible options for order code "Electrical connection"
	Output	Power supply	
Options <b>A, B</b>	Terminals	Terminals	<ul style="list-style-type: none"> <li>▪ Option <b>A</b>: coupling M20x1</li> <li>▪ Option <b>B</b>: thread M20x1</li> <li>▪ Option <b>C</b>: thread G ½"</li> <li>▪ Option <b>D</b>: thread NPT ½"</li> </ul>
Options <b>A, B</b>	Device plugs →  30	Terminals	<ul style="list-style-type: none"> <li>▪ Option <b>L</b>: plug M12x1 + thread NPT ½"</li> <li>▪ Option <b>N</b>: plug M12x1 + coupling M20</li> <li>▪ Option <b>P</b>: plug M12x1 + thread G ½"</li> <li>▪ Option <b>U</b>: plug M12x1 + thread M20</li> </ul>
Options <b>A, B, C</b>	Device plugs →  30	Device plugs →  30	Option <b>Q</b> : 2 x plug M12x1
Order code for "Housing": <ul style="list-style-type: none"> <li>▪ Option <b>A</b>: compact, coated aluminum</li> <li>▪ Option <b>B</b>: compact, stainless</li> <li>▪ Option <b>C</b>: ultra-compact, stainless</li> </ul>			

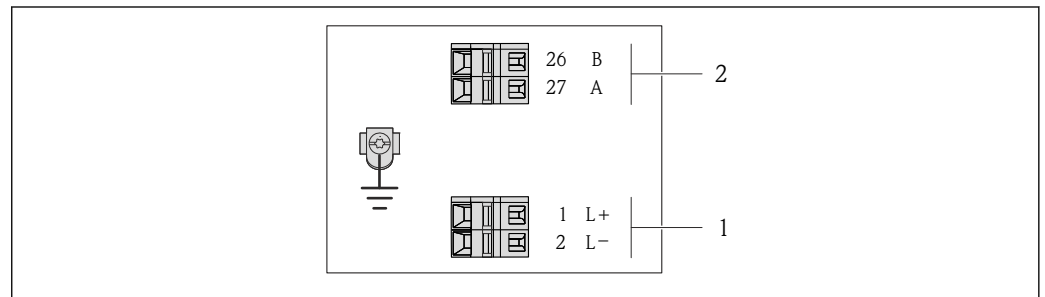

A0022716

 3 PROFIBUS DP terminal assignment

- 1 Power supply: DC 24 V
- 2 PROFIBUS DP



Order code for "Output"	Terminal number			
	Power supply		Output	
	2 (L-)	1 (L+)	26 (Rx/D/TxD-P)	27 (Rx/D/TxD-N)
Option <b>L</b>	DC 24 V		B	A
Order code for "Output": Option <b>L</b> : PROFIBUS DP, for use in non-hazardous areas and Zone 2/div. 2				

Modbus RS485 connection version

 For use in the non-hazardous area and Zone 2/Div. 2.

Order code for "Output", option **M**

Depending on the housing version, the transmitters can be ordered with terminals or device plugs.

Order code for "Housing"	Connection methods available		Possible options for order code "Electrical connection"
	Output	Power supply	
Options A, B	Terminals	Terminals	<ul style="list-style-type: none"> <li>▪ Option A: coupling M20x1</li> <li>▪ Option B: thread M20x1</li> <li>▪ Option C: thread G ½"</li> <li>▪ Option D: thread NPT ½"</li> </ul>
Options A, B	Device plugs →  30	Terminals	<ul style="list-style-type: none"> <li>▪ Option L: plug M12x1 + thread NPT ½"</li> <li>▪ Option N: plug M12x1 + coupling M20</li> <li>▪ Option P: plug M12x1 + thread G ½"</li> <li>▪ Option U: plug M12x1 + thread M20</li> </ul>
Options A, B, C	Device plugs →  30	Device plugs →  30	Option Q: 2 x plug M12x1
Order code for "Housing": <ul style="list-style-type: none"> <li>▪ Option A: compact, coated aluminum</li> <li>▪ Option B: compact, stainless</li> <li>▪ Option C: ultra-compact, stainless</li> </ul>			

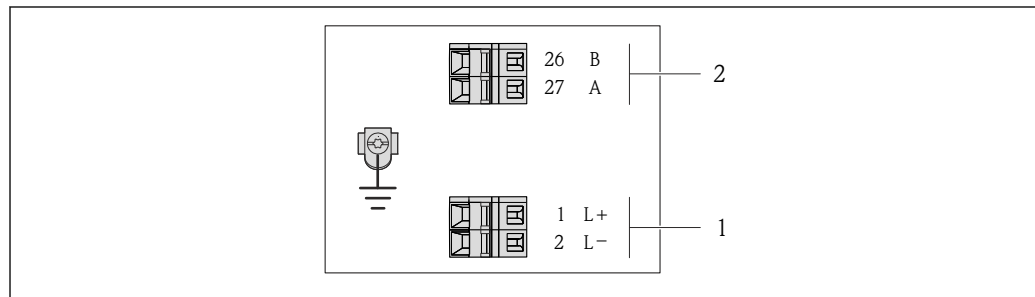

A0019528

 4 Modbus RS485 terminal assignment, connection version for use in non-hazardous areas and Zone 2/Div. 2

- 1 Power supply: DC 24 V
- 2 Modbus RS485

Order code for "Output"	Terminal number			
	Power supply		Output	
	2 (L-)	1 (L+)	27 (B)	26 (A)
Option <b>M</b>	DC 24 V		Modbus RS485	
Order code for "Output": Option <b>M</b> Modbus RS485, for use in non-hazardous areas and Zone 2/Div. 2				

*Modbus RS485 connection version*

 For use in the intrinsically safe area. Connection via Safety Barrier Promass 100.

Order code for "Output", option **M**

Depending on the housing version, the transmitters can be ordered with terminals or device plugs.

Order code for "Housing"	Connection methods available		Possible options for order code "Electrical connection"
	Output	Power supply	
Options A, B	Terminals	Terminals	<ul style="list-style-type: none"> <li>▪ Option A: coupling M20x1</li> <li>▪ Option B: thread M20x1</li> <li>▪ Option C: thread G ½"</li> <li>▪ Option D: thread NPT ½"</li> </ul>
A, B, C	Device plugs →  30		Option I: plug M12x1
Order code for "Housing": <ul style="list-style-type: none"> <li>▪ Option A: compact, coated aluminum</li> <li>▪ Option B: compact, stainless</li> <li>▪ Option C: ultra-compact, stainless</li> </ul>			

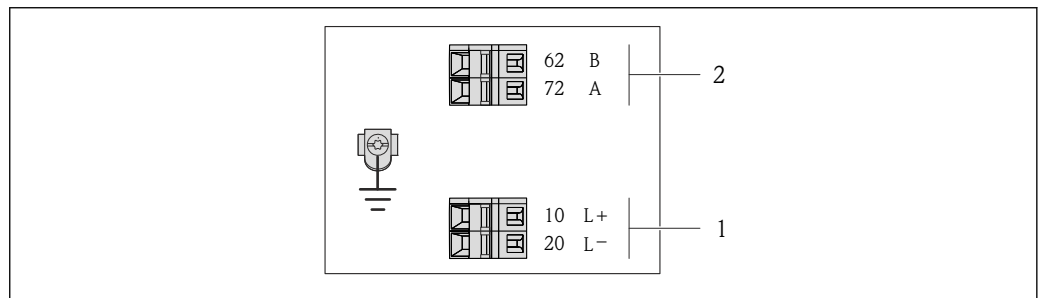

A0017053

 5 *Modbus RS485 terminal assignment, connection version for use in intrinsically safe areas (connection via Safety Barrier Promass 100)*

1 *Intrinsically safe power supply*

2 *Modbus RS485*

Order code for "Output"	20 (L-)	10 (L+)	72 (B)	62 (A)
Option <b>M</b>	Intrinsically safe supply voltage		Modbus RS485 intrinsically safe	
Order code for "Output": Option <b>M</b> : Modbus RS485, for use in intrinsically safe areas (connection via Safety Barrier Promass 100)				

*EtherNet/IP connection version*

Order code for "Output", option **N**

Depending on the housing version, the transmitters can be ordered with terminals or device plugs.

Order code for "Housing"	Connection methods available		Possible options for order code "Electrical connection"
	Output	Power supply	
Options <b>A, B</b>	Device plugs → 30	Terminals	<ul style="list-style-type: none"> <li>▪ Option <b>L</b>: plug M12x1 + thread NPT ½"</li> <li>▪ Option <b>N</b>: plug M12x1 + coupling M20</li> <li>▪ Option <b>P</b>: plug M12x1 + thread G ½"</li> <li>▪ Option <b>U</b>: plug M12x1 + thread M20</li> </ul>
Options <b>A, B, C</b>	Device plugs → 30	Device plugs → 30	Option <b>Q</b> : 2 x plug M12x1

Order code for "Housing":

- Option **A**: compact, coated aluminum
- Option **B**: compact, stainless
- Option **C**: ultra-compact, stainless

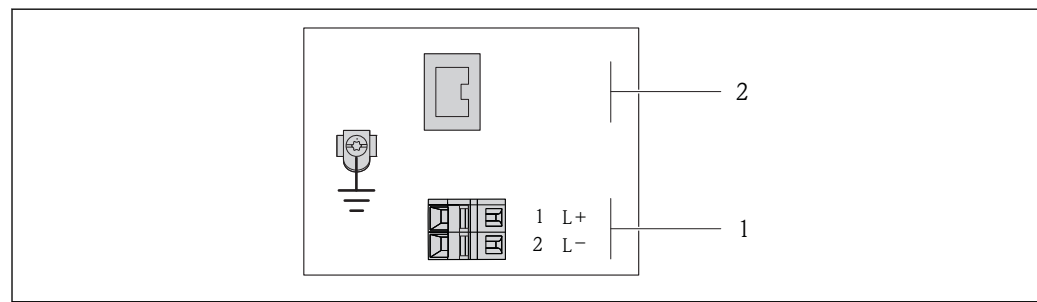

A0017054

6 EtherNet/IP terminal assignment

- 1 Power supply: DC 24 V
- 2 EtherNet/IP



Order code for "Output"	Terminal number		Output Device plug M12x1
	Power supply 2 (L-)	1 (L+)	
Option <b>N</b>	DC 24 V		EtherNet/IP

Order code for "Output":  
Option **N**: EtherNet/IP

*PROFINET connection version*

Order code for "Output", option **R**

Depending on the housing version, the transmitters can be ordered with terminals or device plugs.

Order code for "Housing"	Connection methods available		Possible options for order code "Electrical connection"
	Output	Power supply	
Options <b>A, B</b>	Device plugs →  30	Terminals	<ul style="list-style-type: none"> <li>▪ Option <b>L</b>: plug M12x1 + thread NPT 1/2"</li> <li>▪ Option <b>N</b>: plug M12x1 + coupling M20</li> <li>▪ Option <b>P</b>: plug M12x1 + thread G 1/2"</li> <li>▪ Option <b>U</b>: plug M12x1 + thread M20</li> </ul>
Options <b>A, B, C</b>	Device plugs →  30	Device plugs →  30	Option <b>Q</b> : 2 x plug M12x1
Order code for "Housing": <ul style="list-style-type: none"> <li>▪ Option <b>A</b>: compact, coated aluminum</li> <li>▪ Option <b>B</b>: compact, stainless</li> <li>▪ Option <b>C</b>: ultra-compact, stainless</li> </ul>			

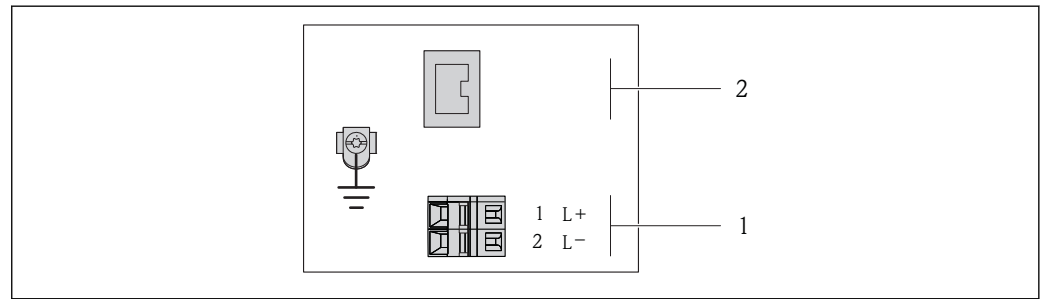

A0017054

 7 *PROFINET terminal assignment*

- 1 Power supply: DC 24 V
- 2 PROFINET

Order code for "Output"	Terminal number		Output Device plug M12x1
	Power supply 2 (L-)	1 (L+)	
Option <b>R</b>	DC 24 V		PROFINET
Order code for "Output": Option <b>R</b> : PROFINET			

Safety Barrier Promass 100

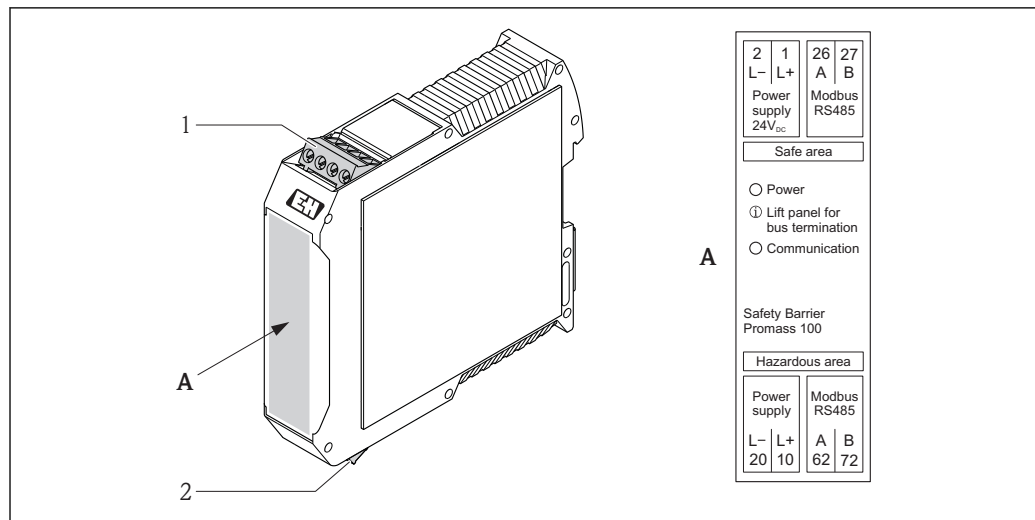

A0016922

8 Safety Barrier Promass 100 with terminals

- 1 Non-hazardous area and Zone 2/Div. 2
- 2 Intrinsically safe area

Pin assignment, device plug

- i** Order codes for the M12x1 connectors, see the "Order code for **electrical connection**" column:
  - 4-20 mA HART, pulse/frequency/switch output → 24
  - PROFIBUS DP → 25
  - Modbus RS485 → 26
  - EtherNet/IP → 28
  - PROFINET → 29

Supply voltage

For all connection versions except MODBUS RS485 intrinsically safe (device side)

- i** Device plug MODBUS RS485 intrinsically safe with supply voltage → 31

<p style="text-align: center;">A0016809</p>	Pin	Assignment	
	1	L+	DC 24 V
	2		Not assigned
	3		Not assigned
	4	L-	DC 24 V
	5		Grounding/shielding
Coding		Plug/socket	
A		Plug	

- i** The following is recommended as a socket:
  - Binder, series 763, part no. 79 3440 35 05
  - Alternatively: Phoenix part no. 1669767 SAC-5P-M12MS
    - With the order code for "Output", option **B**: 4-20 mA HART, pulse/frequency/switch output
    - With the order code for "Output", option **N**: EtherNet/IP
  - When using the device in a hazardous location: Use a suitably certified socket.

**4-20 mA HART with pulse/frequency/switch output**

Device plug for signal transmission (device side)

	Pin		Assignment
	1	+	4-20 mA HART (active)
	2	-	4-20 mA HART (active)
	3	+	Pulse/frequency/switch output (passive)
	4	-	Pulse/frequency/switch output (passive)
	5		Grounding/shielding
Coding		Plug/socket	
A		Socket	

- Recommended plug: Binder, series 763, part no. 79 3439 12 05
- When using the device in a hazardous location, use a suitably certified plug.

**PROFIBUS DP**

For use in the non-hazardous area and Zone 2/Div. 2.

Device plug for signal transmission (device side)

	Pin		Assignment
	1		Not assigned
	2	A	PROFIBUS DP
	3		Not assigned
	4	B	PROFIBUS DP
	5		Grounding/shielding
Coding		Plug/socket	
B		Socket	

- Recommended plug: Binder, series 763, part no. 79 4449 20 05
- When using the device in a hazardous location, use a suitably certified plug.

**MODBUS RS485**

Device plug for signal transmission with supply voltage (device side), MODBUS RS485 (intrinsically safe)

	Pin		Assignment
	1	L+	Supply voltage, intrinsically safe
	2	A	Modbus RS485 intrinsically safe
	3	B	
	4	L-	Supply voltage, intrinsically safe
	5		Grounding/shielding
Coding		Plug/socket	
A		Plug	

- Recommended socket: Binder, series 763, part no. 79 3439 12 05
- When using the device in a hazardous location: Use a suitably certified socket.

Device plug for signal transmission (device side), MODBUS RS485 (not intrinsically safe)

 For use in the non-hazardous area and Zone 2/Div. 2.

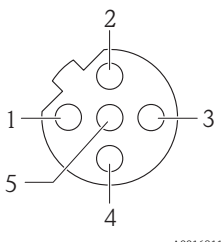
	Pin	Assignment	
	1		Not assigned
	2	A	Modbus RS485
	3		Not assigned
	4	B	Modbus RS485
	5		Grounding/shielding
Coding		Plug/socket	
B		Socket	

-  Recommended plug: Binder, series 763, part no. 79 4449 20 05
- When using the device in a hazardous location, use a suitably certified plug.

### EtherNet/IP

Device plug for signal transmission (device side)

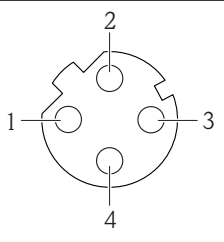
	Pin	Assignment	
	1	+	Tx
	2	+	Rx
	3	-	Tx
	4	-	Rx
	Coding		Plug/socket
D		Socket	

-  Recommended plug:
- Binder, series 763, part no. 99 3729 810 04
  - Phoenix, part no. 1543223 SACC-M12MSD-4Q
  - When using the device in a hazardous location, use a suitably certified plug.

### PROFINET

Device plug for signal transmission (device side)

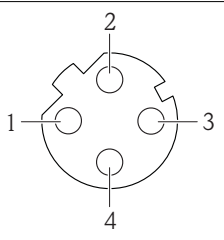
	Pin	Assignment	
	1	+	TD +
	2	+	RD +
	3	-	TD -
	4	-	RD -
	Coding		Plug/socket
D		Socket	

-  Recommended plug:
- Binder, series 763, part no. 99 3729 810 04
  - Phoenix, part no. 1543223 SACC-M12MSD-4Q
  - When using the device in a hazardous location, use a suitably certified plug.

### Supply voltage

The power unit must be tested to ensure it meets safety requirements (e.g. PELV, SELV).



**Transmitter**

For device version with communication type:

- HART, PROFIBUS DP, EtherNet/IP: DC 20 to 30 V
- Modbus RS485, device version:
  - For use in the non-hazardous area and Zone 2/Div. 2: DC 20 to 30 V
  - For use in the intrinsically safe area: power supply via Safety Barrier Promass 100

**Safety Barrier Promass 100**

DC 20 to 30 V

**Power consumption**

**Transmitter**

Order code for "Output"	Maximum Power consumption
Option <b>B</b> : 4-20 mA HART with pulse/frequency/switch output	3.5 W
Option <b>L</b> : PROFIBUS DP	3.5 W
Option <b>M</b> Modbus RS485, for use in non-hazardous areas and Zone 2/Div. 2	3.5 W
Option <b>M</b> : Modbus RS485, for use in intrinsically safe areas	2.45 W
Option <b>N</b> : EtherNet/IP	3.5 W
Option <b>R</b> : PROFINET	3.5 W

*Safety Barrier Promass 100*

Order code for "Output"	Maximum Power consumption
Option <b>M</b> : Modbus RS485, for use in intrinsically safe areas	4.8 W

**Current consumption**

**Transmitter**

Order code for "Output"	Maximum Current consumption	Maximum switch-on current
Option <b>B</b> : 4-20mA HART, pul./freq./switch output	145 mA	18 A (< 0.125 ms)
Option <b>L</b> : PROFIBUS DP	145 mA	18 A (< 0.125 ms)
Option <b>M</b> Modbus RS485, for use in non-hazardous areas and Zone 2/Div. 2	90 mA	10 A (< 0.8 ms)
Option <b>M</b> : Modbus RS485, for use in intrinsically safe areas	145 mA	16 A (< 0.4 ms)
Option <b>N</b> : EtherNet/IP	145 mA	18 A (< 0.125 ms)
Option <b>R</b> : PROFINET	145 mA	18 A (< 0.125 ms)

**Safety Barrier Promass 100**

Order code for "Output"	Maximum Current consumption	Maximum switch-on current
Option <b>M</b> : Modbus RS485, for use in intrinsically safe areas	230 mA	10 A (< 0.8 ms)

**Power supply failure**

- Totalizers stop at the last value measured.
- Depending on the device version, the configuration is retained in the device memory or in the plug-in memory (HistoROM DAT).
- Configuration is retained in the plug-in memory (HistoROM DAT).
- Error messages (incl. total operated hours) are stored.

## Electrical connection

## Connecting the transmitter

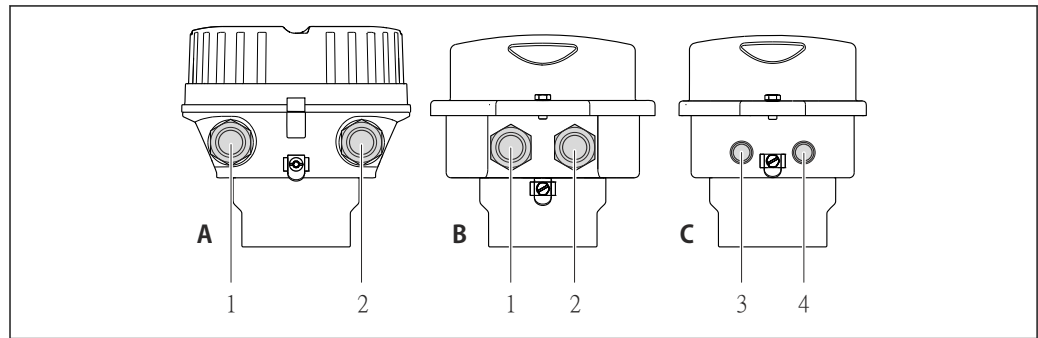

A0016924

- A Housing version: compact, aluminum coated  
 B Housing version: compact, stainless  
 1 Cable entry or device plug for signal transmission  
 2 Cable entry or device plug for supply voltage  
 C Housing version: ultra-compact, stainless  
 3 Device plug for signal transmission  
 4 Device plug for supply voltage

- i** Terminal assignment → 23
- i** Pin assignment, device plug → 30

**i** In the case of device versions with a connector, the transmitter housing does not need to be opened to connect the signal cable or power supply cable.

## Connection examples

## Current output 4-20 mA HART

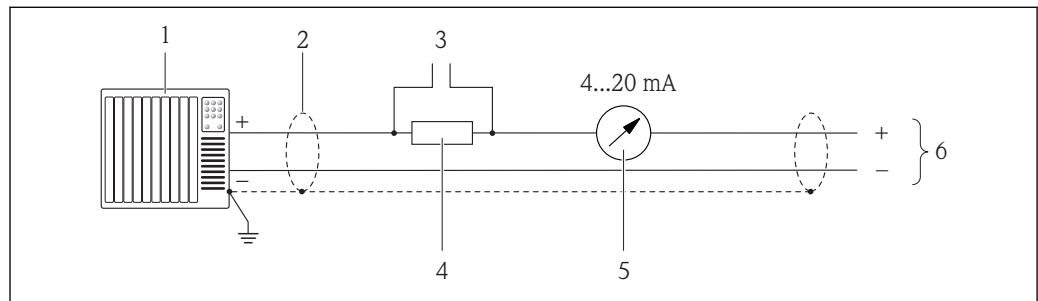

A0016800

- 9** Connection example for 4-20 mA HART current output (active)
- 1 Automation system with current input (e.g. PLC)  
 2 Cable shield, observe cable specifications  
 3 Connection for HART operating devices  
 4 Resistor for HART communication ( $\geq 250 \Omega$ ): observe maximum load  
 5 Analog display unit: observe maximum load  
 6 Transmitter

Pulse/frequency output

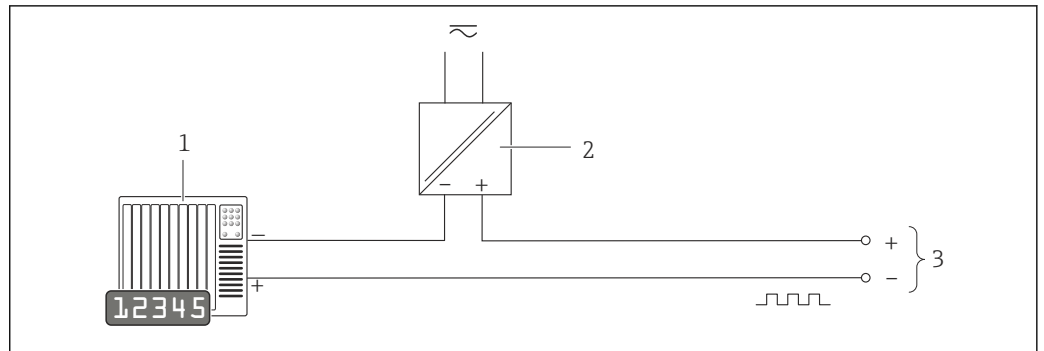

A0016801

10 Connection example for pulse/frequency output (passive)

- 1 Automation system with pulse/frequency input (e.g. PLC)
- 2 Power supply
- 3 Transmitter: observe input values → 9

Switch output

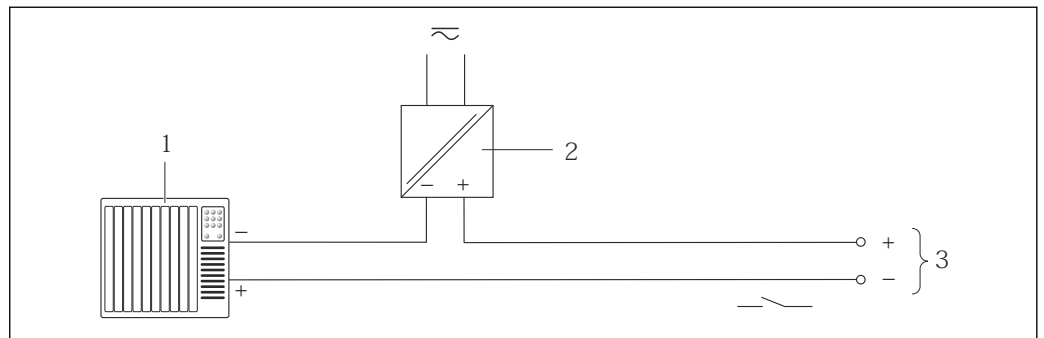

A0016802

11 Connection example for switch output (passive)

- 1 Automation system with switch input (e.g. PLC)
- 2 Power supply
- 3 Transmitter: observe input values

## PROFIBUS DP

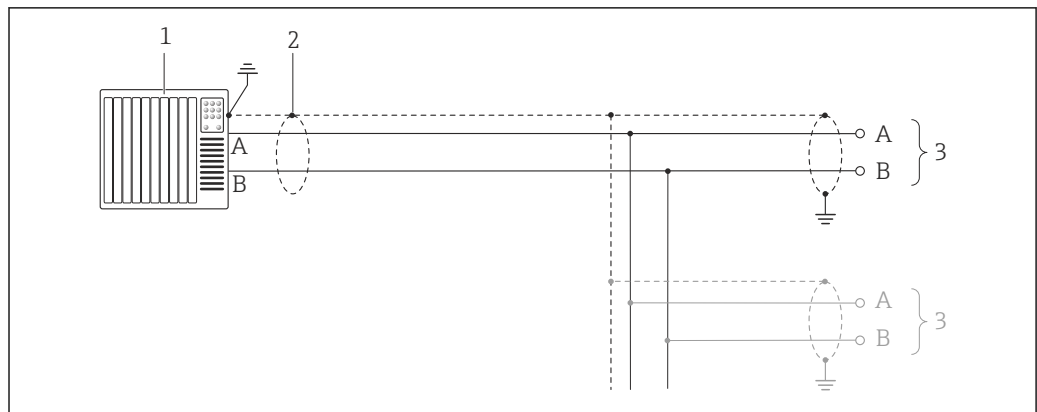

12 Connection example for PROFIBUS DP, non-hazardous area and Zone 2/Div. 2

- 1 Control system (e.g. PLC)
- 2 Cable shield: the cable shield must be grounded at both ends to comply with EMC requirements; observe cable specifications
- 3 Transmitter

**i** If baud rates > 1.5 MBaud an EMC cable entry must be used and the cable shield must continue as far as the terminal wherever possible.

## Modbus RS485

## Modbus RS485, non-hazardous area and Zone 2/Div. 2

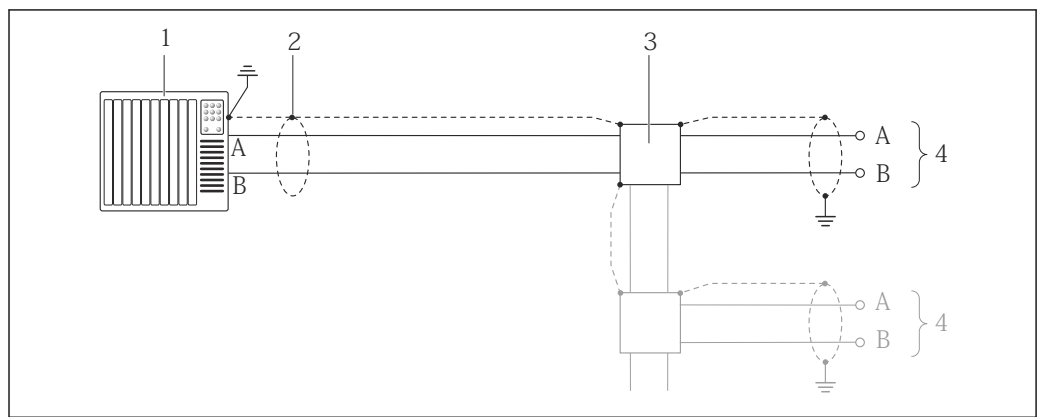

13 Connection example for Modbus RS485, non-hazardous area and Zone 2/Div. 2

- 1 Control system (e.g. PLC)
- 2 Cable shield: the cable shield must be grounded at both ends to comply with EMC requirements; observe cable specifications
- 3 Distribution box
- 4 Transmitter

Modbus RS485 intrinsically safe

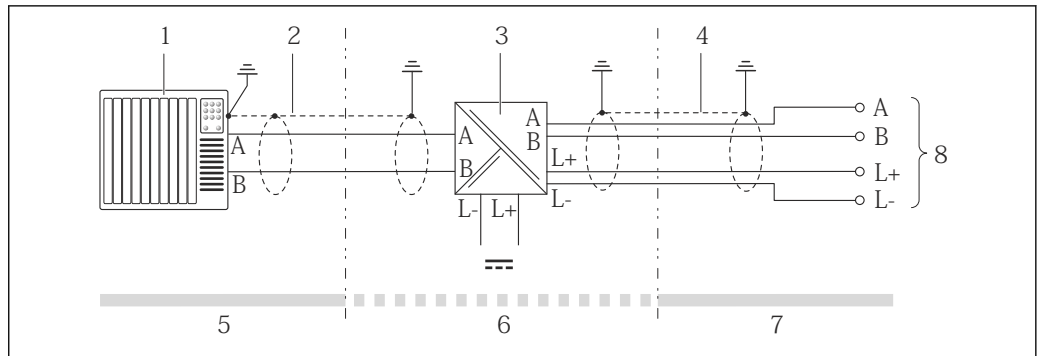

A0016804

14 Connection example for Modbus RS485 intrinsically safe

- 1 Control system (e.g. PLC)
- 2 Cable shield, observe cable specifications
- 3 Safety Barrier Promass 100
- 4 Observe cable specifications
- 5 Non-hazardous area
- 6 Non-hazardous area and Zone 2/Div. 2
- 7 Intrinsically safe area
- 8 Transmitter

EtherNet/IP

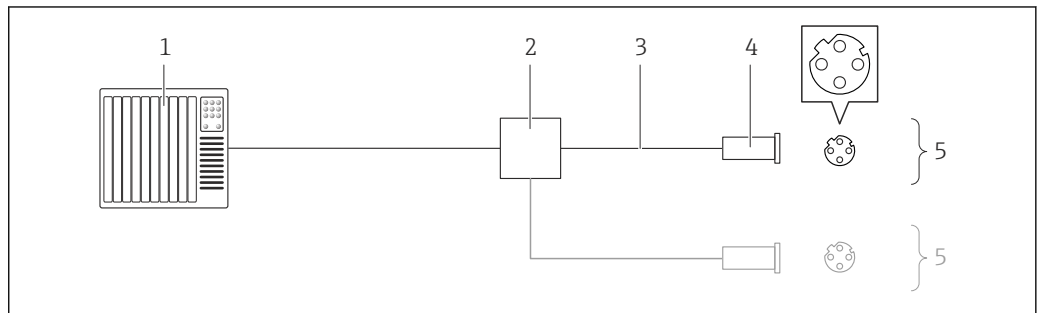

A0016805

15 Connection example for EtherNet/IP

- 1 Control system (e.g. PLC)
- 2 Ethernet switch
- 3 Observe cable specifications
- 4 Device plug
- 5 Transmitter

PROFINET

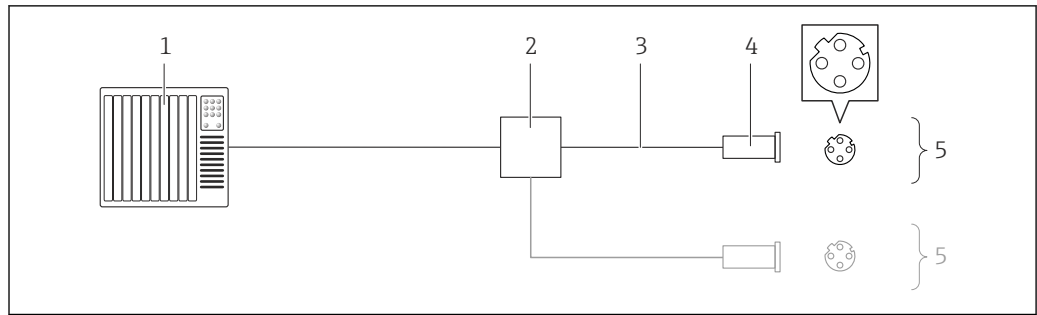

A0016805

16 Connecting cable for PROFINET

- 1 Control system (e.g. PLC)
- 2 Ethernet switch
- 3 Observe cable specifications
- 4 Connector
- 5 Transmitter

HART input

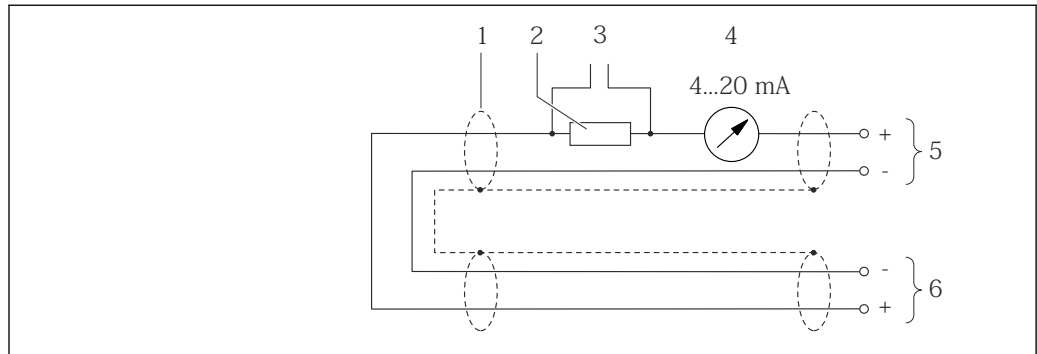

A0019828

17 Connection example for HART input (burst mode) via current output (active)

- 1 Cable shield, observe cable specifications
- 2 Resistor for HART communication ( $\geq 250 \Omega$ ): observe maximum load
- 3 Connection for HART operating devices
- 4 Analog display unit
- 5 Transmitter
- 6 Sensor for external measured variable

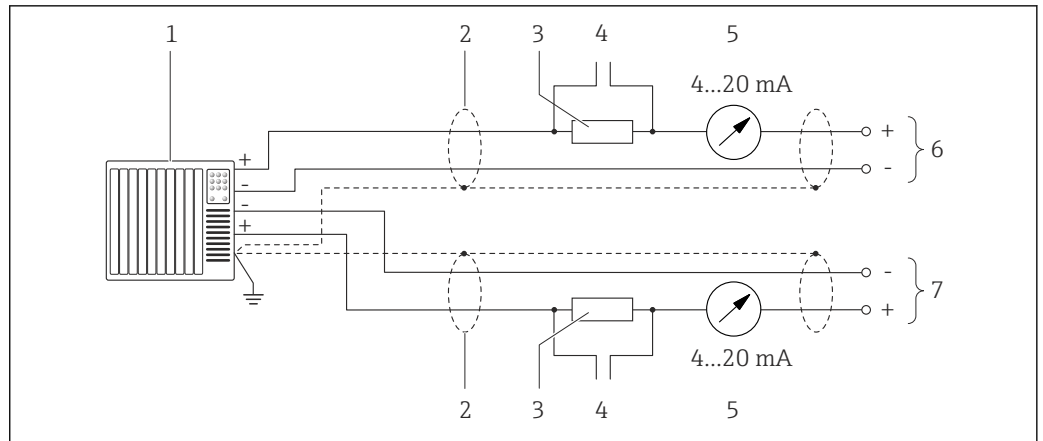

18 Connection example for HART input (master mode) via current output (active)

- 1 Automation system with current input (e.g. PLC).  
Prerequisite: automation system with HART version 6, HART commands 113 and 114 can be processed.
- 2 Cable shield, observe cable specifications
- 3 Resistor for HART communication ( $\geq 250 \Omega$ ): observe maximum load
- 4 Connection for HART operating devices
- 5 Analog display unit
- 6 Transmitter
- 7 Sensor for external measured variable

**Potential equalization**

**Requirements**

No special measures for potential equalization are required.

Please consider the following to ensure correct measurement:

- Same electrical potential for the fluid and sensor
- Company-internal grounding concepts

For devices intended for use in hazardous locations, please observe the guidelines in the Ex documentation (XA).

**Terminals**

**Transmitter**

Spring terminals for wire cross-sections 0.5 to 2.5 mm<sup>2</sup> (20 to 14 AWG)

**Safety Barrier Promass 100**

Plug-in screw terminals for wire cross-sections 0.5 to 2.5 mm<sup>2</sup> (20 to 14 AWG)

**Cable entries**

- Cable gland: M20 × 1.5 with cable  $\phi$ 6 to 12 mm (0.24 to 0.47 in)
- Thread for cable entry:
  - NPT 1/2"
  - G 1/2"
  - M20

**Cable specification**

**Permitted temperature range**

- -40 °C (-40 °F) to +80 °C (+176 °F)
- Minimum requirement: cable temperature range  $\geq$  ambient temperature +20 K

**Power supply cable**

Standard installation cable is sufficient.

**Signal cable**

*Current output*

For 4-20 mA HART: Shielded cable recommended. Observe grounding concept of the plant.

*Pulse/frequency/switch output*

Standard installation cable is sufficient.

*PROFIBUS DP*

The IEC 61158 standard specifies two types of cable (A and B) for the bus line which can be used for every transmission rate. Cable type A is recommended.

<b>Cable type</b>	A
<b>Characteristic impedance</b>	135 to 165 $\Omega$ at a measuring frequency of 3 to 20 MHz
<b>Cable capacitance</b>	<30 pF/m
<b>Wire cross-section</b>	>0.34 mm <sup>2</sup> (22 AWG)
<b>Cable type</b>	Twisted pairs
<b>Loop resistance</b>	$\leq$ 110 $\Omega$ /km
<b>Signal damping</b>	Max. 9 dB over the entire length of the cable cross-section
<b>Shield</b>	Copper braided shielding or braided shielding with foil shield. When grounding the cable shield, observe the grounding concept of the plant.

*Modbus RS485*

The EIA/TIA-485 standard specifies two types of cable (A and B) for the bus line which can be used for every transmission rate. Cable type A is recommended.

<b>Cable type</b>	A
<b>Characteristic impedance</b>	135 to 165 $\Omega$ at a measuring frequency of 3 to 20 MHz
<b>Cable capacitance</b>	<30 pF/m
<b>Wire cross-section</b>	>0.34 mm <sup>2</sup> (22 AWG)
<b>Cable type</b>	Twisted pairs
<b>Loop resistance</b>	$\leq$ 110 $\Omega$ /km
<b>Signal damping</b>	Max. 9 dB over the entire length of the cable cross-section
<b>Shield</b>	Copper braided shielding or braided shielding with foil shield. When grounding the cable shield, observe the grounding concept of the plant.

*EtherNet/IP*

The standard ANSI/TIA/EIA-568-B.2 Annex specifies CAT 5 as the minimum category for a cable used for EtherNet/IP. CAT 5e and CAT 6 are recommended.



For more information on planning and installing EtherNet/IP networks, please refer to the "Media Planning and Installation Manual. EtherNet/IP" of ODVA Organization

*PROFINET*

Standard IEC 61156-6 specifies CAT 5 as the minimum category for a cable used for PROFINET. CAT 5e and CAT 6 are recommended.



For more information on planning and installing PROFINET networks, see: "PROFINET Cabling and Interconnection Technology", Guideline for PROFINET

**Connecting cable between Safety Barrier Promass 100 and measuring device**

<b>Cable type</b>	Shielded twisted-pair cable with 2x2 wires. When grounding the cable shield, observe the grounding concept of the plant.
<b>Maximum cable resistance</b>	2.5 $\Omega$ , one side



Comply with the maximum cable resistance specifications to ensure the operational reliability of the measuring device.





The maximum cable length for individual wire cross-sections is specified in the table below. Observe the maximum capacitance and inductance per unit length of the cable and connection values for hazardous areas .

Wire cross-section		Maximum cable length	
[mm <sup>2</sup> ]	[AWG]	[m]	[ft]
0.5	20	70	230
0.75	18	100	328
1.0	17	100	328
1.5	16	200	656
2.5	14	300	984

## Performance characteristics

### Reference operating conditions

- Error limits based on ISO 11631
- Water with +15 to +45 °C (+59 to +113 °F) at 2 to 6 bar (29 to 87 psi)
- Specifications as per calibration protocol
- Accuracy based on accredited calibration rigs that are traced to ISO 17025.

 To obtain measured errors, use the *Applicator* sizing tool →  76

### Maximum measured error

o.r. = of reading; 1 g/cm<sup>3</sup> = 1 kg/l; T = medium temperature

#### Base accuracy

 Design fundamentals →  44

#### Mass flow and volume flow (liquids)

±0.10 % o.r.

#### Mass flow (gases)

±0.50 % o.r. (tantalum 2.5W)

#### Density (liquids)

Under reference operating conditions		Standard density calibration <sup>1)</sup>		Wide-range density specification <sup>2) 3)</sup>	
[g/cm <sup>3</sup> ]	[lbs/in <sup>3</sup> ]	[g/cm <sup>3</sup> ]	[lbs/in <sup>3</sup> ]	[g/cm <sup>3</sup> ]	[lbs/in <sup>3</sup> ]
±0.0005	±0.00097	±0.02	±0.039	±0.002	±0.0039

- 1) Valid over the entire temperature and density range
- 2) Valid range for special density calibration: 0 to 2 g/cm<sup>3</sup>, +5 to +80 °C (+41 to +176 °F)
- 3) Order code for "Application package", option EF "Special density and concentration "

#### Temperature

±0.5 °C ± 0.005 · T °C (±0.9 °F ± 0.003 · (T - 32) °F)

**Zero point stability**

DN		Zero point stability	
[mm]	[in]	[kg/h]	[lb/min]
8	$\frac{3}{8}$	0.40	0.015
15	$\frac{1}{2}$	0.65	0.024
25	1	1.80	0.066
40	$1\frac{1}{2}$	9.00	0.331
50	2	14.00	0.514

**Flow values**

Flow values as turndown parameter depending on nominal diameter.

*SI units*

DN	1:1	1:10	1:20	1:50	1:100	1:500
[mm]	[kg/h]	[kg/h]	[kg/h]	[kg/h]	[kg/h]	[kg/h]
8	2 000	200	100	40	20	4
15	6 500	650	325	130	65	13
25	18 000	1 800	900	360	180	36
40	45 000	4 500	2 250	900	450	90
50	70 000	7 000	3 500	1 400	700	140

*US units*

DN	1:1	1:10	1:20	1:50	1:100	1:500
[inch]	[lb/min]	[lb/min]	[lb/min]	[lb/min]	[lb/min]	[lb/min]
$\frac{3}{8}$	73.50	7.350	3.675	1.470	0.735	0.147
$\frac{1}{2}$	238.9	23.89	11.95	4.778	2.389	0.478
1	661.5	66.15	33.08	13.23	6.615	1.323
$1\frac{1}{2}$	1 654	165.4	82.70	33.08	16.54	3.308
2	2 573	257.3	128.7	51.46	25.73	5.146

**Accuracy of outputs**

In the case of analog outputs, the output accuracy must also be considered for the measured error; in contrast, this need not be considered in the case of fieldbus outputs (e.g. Modbus RS485, EtherNet/IP).

The outputs have the following base accuracy specifications.

*Current output*

<b>Accuracy</b>	Max. $\pm 5 \mu\text{A}$
-----------------	--------------------------

*Pulse/frequency output*

o.r. = of reading

<b>Accuracy</b>	Max. $\pm 50 \text{ ppm o.r.}$ (across the entire ambient temperature range)
-----------------	--

**Repeatability**

o.r. = of reading;  $1 \text{ g/cm}^3 = 1 \text{ kg/l}$ ; T = medium temperature

**Base repeatability**

**Mass flow and volume flow (liquids)**

$\pm 0.05 \%$  o.r.

**Mass flow (gases)**

$\pm 0.25 \%$  o.r. (tantalum 2.5W)

 Design fundamentals →  44

**Density (liquids)**

$\pm 0.00025 \text{ g/cm}^3$

**Temperature**

$\pm 0.25 \text{ }^\circ\text{C} \pm 0.0025 \cdot T \text{ }^\circ\text{C}$  ( $\pm 0.45 \text{ }^\circ\text{F} \pm 0.0015 \cdot (T-32) \text{ }^\circ\text{F}$ )

**Response time**

The response time depends on the configuration (damping).

**Influence of ambient temperature**

**Current output**

o.r. = of reading

<b>Temperature coefficient</b>	Max. $\pm 0.005\%$ o.r./ $^\circ\text{C}$
--------------------------------	---

**Pulse/frequency output**

<b>Temperature coefficient</b>	No additional effect. Included in accuracy.
--------------------------------	---

**Influence of medium temperature**

**Mass flow and volume flow**

When there is a difference between the temperature for zero point adjustment and the process temperature, the typical measured error of the sensor is  $\pm 0.0002 \%$  of the full scale value/ $^\circ\text{C}$  ( $\pm 0.0001 \%$  of the full scale value/ $^\circ\text{F}$ ).

**Density**

When there is a difference between the density calibration temperature and the process temperature, the typical measured error of the sensor is  $\pm 0.0001 \text{ g/cm}^3 \text{ }^\circ\text{C}$  ( $\pm 0.00005 \text{ g/cm}^3 \text{ }^\circ\text{F}$ ). Field density calibration is possible.

**Wide-range density specification (special density calibration)**

If the process temperature is outside the valid range (→  41) the measured error is  $\pm 0.0001 \text{ g/cm}^3 \text{ }^\circ\text{C}$  ( $\pm 0.00005 \text{ g/cm}^3 \text{ }^\circ\text{F}$ )

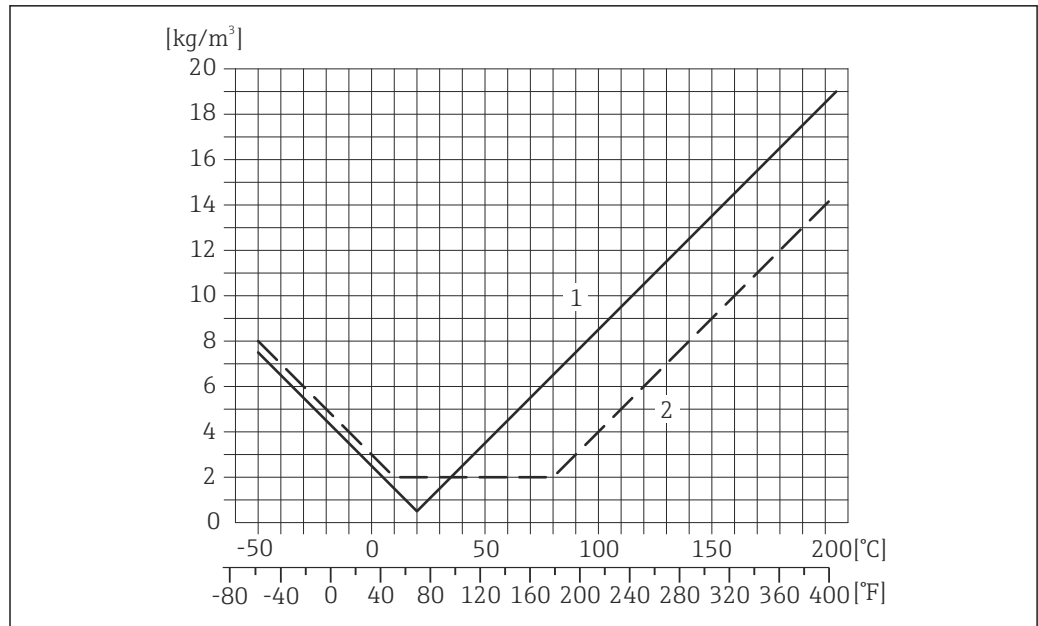

A0016615

- 1 Field density calibration, for example at +20 °C (+68 °F)
- 2 Special density calibration

**Temperature**

$\pm 0.005 \cdot T \text{ } ^\circ\text{C}$  ( $\pm 0.005 \cdot (T - 32) \text{ } ^\circ\text{F}$ )

**Influence of medium pressure**

The table below shows the effect on accuracy of mass flow due to a difference between calibration pressure and process pressure.

o.r. = of reading

DN		Promass H zirconium 702/R 60702		Promass H tantalum 2.5W	
[mm]	[in]	[% o.r./bar]	[% o.r./psi]	[% o.r./bar]	[% o.r./psi]
8	3/8	-0.017	-0.0012	-0.007	-0.0005
15	1/2	-0.021	-0.0014	-0.005	-0.0003
25	1	-0.013	-0.0009	-0.015	-0.0010
40	1 1/2	-0.018	-0.0012	-0.012	-0.0008
50	2	-0.015	-0.0010	-0.011	-0.0008

**Design fundamentals**

o.r. = of reading, o.f.s. = of full scale value

BaseAccu = base accuracy in % o.r., BaseRepeat = base repeatability in % o.r.

MeasValue = measured value; ZeroPoint = zero point stability

Calculation of the maximum measured error as a function of the flow rate

Flow rate	Maximum measured error in % o.r.
$\geq \frac{\text{ZeroPoint}}{\text{BaseAccu}} \cdot 100$ <small>A0021332</small>	$\pm \text{BaseAccu}$ <small>A0021339</small>
$< \frac{\text{ZeroPoint}}{\text{BaseAccu}} \cdot 100$ <small>A0021333</small>	$\pm \frac{\text{ZeroPoint}}{\text{MeasValue}} \cdot 100$ <small>A0021334</small>

Calculation of the maximum repeatability as a function of the flow rate

Flow rate	Maximum repeatability in % o.r.
$\geq \frac{1/2 \cdot \text{ZeroPoint}}{\text{BaseRepeat}} \cdot 100$ <small>A0021335</small>	$\pm \text{BaseRepeat}$ <small>A0021340</small>
$< \frac{1/2 \cdot \text{ZeroPoint}}{\text{BaseRepeat}} \cdot 100$ <small>A0021336</small>	$\pm 1/2 \cdot \frac{\text{ZeroPoint}}{\text{MeasValue}} \cdot 100$ <small>A0021337</small>

**Example for max. measured error**

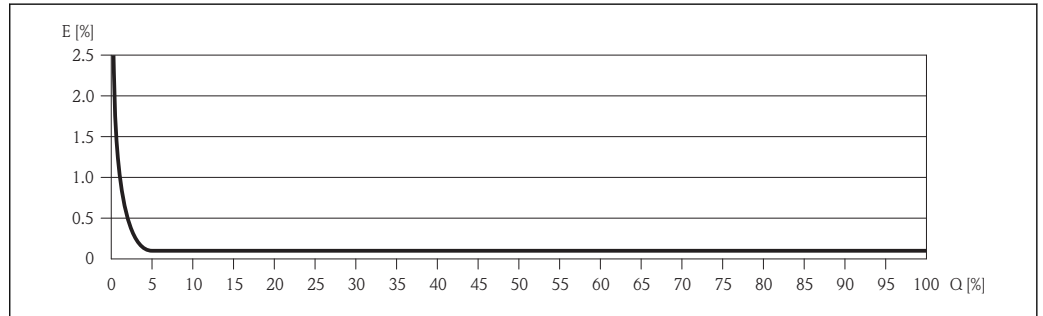

E Error: Maximum measured error as % o.r. (example)  
Q Flow rate as %

## Installation

No special measures such as supports are necessary. External forces are absorbed by the construction of the device.

### Mounting location

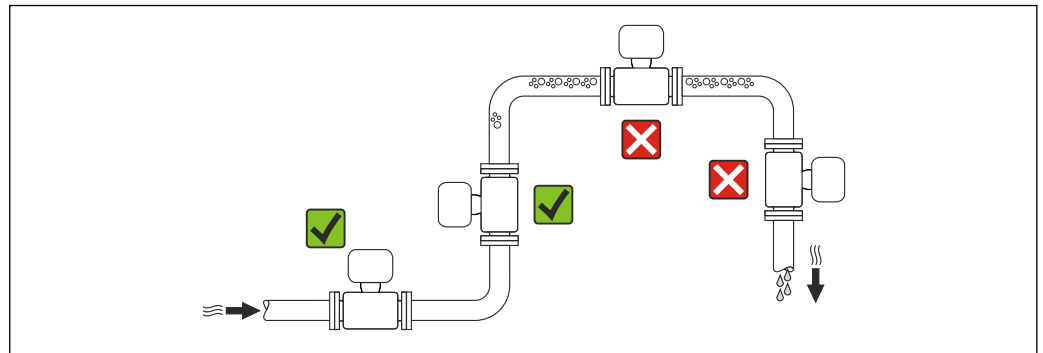

To prevent measuring errors arising from accumulation of gas bubbles in the measuring tube, avoid the following mounting locations in the pipe:

- Highest point of a pipeline.
- Directly upstream of a free pipe outlet in a down pipe.

#### Installation in down pipes

However, the following installation suggestion allows for installation in an open vertical pipeline. Pipe restrictions or the use of an orifice with a smaller cross-section than the nominal diameter prevent the sensor running empty while measurement is in progress.

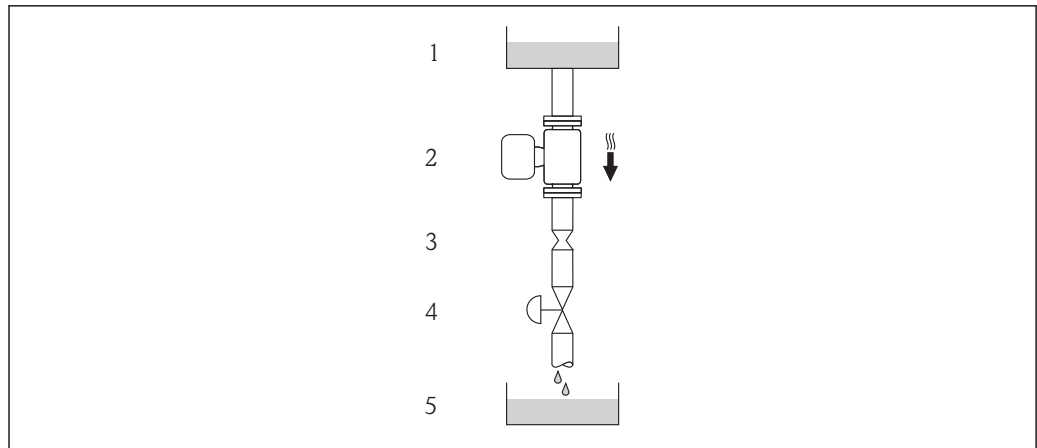

A0015596

19 Installation in a down pipe (e.g. for batching applications)

- 1 Supply tank
- 2 Sensor
- 3 Orifice plate, pipe restriction
- 4 Valve
- 5 Batching tank

DN		Ø orifice plate, pipe restriction	
[mm]	[in]	[mm]	[in]
8	3/8	6	0.24
15	1/2	10	0.40
25	1	14	0.55
40	1 1/2	22	0.87
50	2	28	1.10

**Orientation**

The direction of the arrow on the sensor nameplate helps you to install the sensor according to the flow direction (direction of medium flow through the piping).

Orientation		Recommendation
<b>A</b>	Vertical orientation	 A0015591
<b>B</b>	Horizontal orientation, transmitter head up	 A0015589
<b>C</b>	Horizontal orientation, transmitter head down	 A0015590
<b>D</b>	Horizontal orientation, transmitter head at side	 A0015592

- 1) Applications with low process temperatures may decrease the ambient temperature. To maintain the minimum ambient temperature for the transmitter, this orientation is recommended.
- 2) Applications with high process temperatures may increase the ambient temperature. To maintain the maximum ambient temperature for the transmitter, this orientation is recommended.

If a sensor is installed horizontally with a curved measuring tube, match the position of the sensor to the fluid properties.

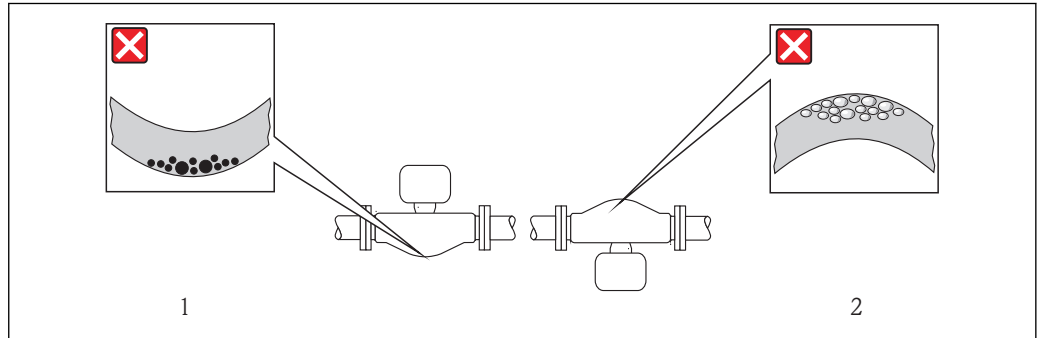

20 Orientation of sensor with curved measuring tube

- 1 Avoid this orientation for fluids with entrained solids: Risk of solids accumulating.
- 2 Avoid this orientation for outgassing fluids: Risk of gas accumulating.

A0014057

**Inlet and outlet runs**

No special precautions need to be taken for fittings which create turbulence, such as valves, elbows or T-pieces, as long as no cavitation occurs → 53.

**Special mounting instructions**

**Zero point adjustment**

All measuring devices are calibrated in accordance with state-of-the-art technology. Calibration takes place under reference conditions → 41. Therefore, a zero point adjustment in the field is generally not required.

Experience shows that zero point adjustment is advisable only in special cases:

- To achieve maximum measuring accuracy even with low flow rates
- Under extreme process or operating conditions (e.g. very high process temperatures or very high-viscosity fluids).

**Mounting Safety Barrier Promass 100**

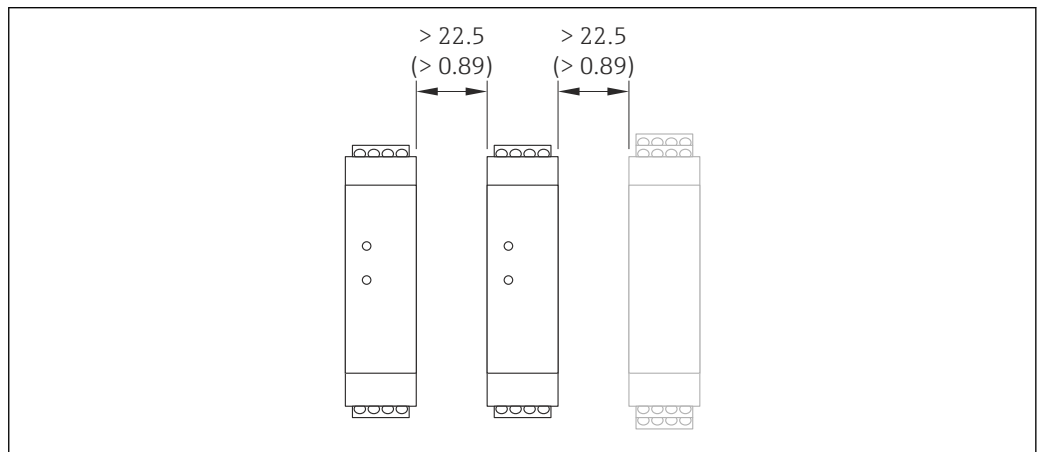

21 Minimum distance between additional Safety Barrier Promass 100 or other modules. Engineering unit mm (in)

A0016894

**Environment**

**Ambient temperature range**

Measuring device	Non-Ex	-40 to +60 °C (-40 to +140 °F)
	Ex na, NI version	-40 to +60 °C (-40 to +140 °F)

	Ex ia, IS version	<ul style="list-style-type: none"> <li>■ -40 to +60 °C (-40 to +140 °F)</li> <li>■ -50 to +60 °C (-58 to +140 °F) (order code for "Test, certificate", option JM))</li> </ul>
<b>Readability of the local display</b>		-20 to +60 °C (-4 to +140 °F) The readability of the display may be impaired at temperatures outside the temperature range.
<b>Safety Barrier Promass 100</b>		-40 to +60 °C (-40 to +140 °F)

- If operating outdoors:  
Avoid direct sunlight, particularly in warm climatic regions.

 Weather protection covers can be ordered from Endress+Hauser: see "Accessories" section

### Temperature tables

In the following tables, the following interdependencies between the maximum medium temperature  $T_m$  for T6 to T1 and the maximum ambient temperature  $T_a$  apply when operating the device in hazardous areas.

#### Ex ia, cCSA<sub>US</sub> IS

##### SI units

Order code for "Housing"	$T_a$ [°C]	T6 [85 °C]	T5 [100 °C]	T4 [135 °C]	T3 [200 °C]	T2 [300 °C]	T1 [450 °C]
Option A "Compact coated alu" Option B "Compact, stainless"	35	50	85	120	150 <sup>1)</sup>	150 <sup>2)</sup>	150 <sup>2)</sup>
	50	–	85	120	150 <sup>1)</sup>	150 <sup>2)</sup>	150 <sup>2)</sup>
	60	–	–	120	150 <sup>1)</sup>	150 <sup>2)</sup>	150 <sup>2)</sup>
Option C "Ultra-compact, stainless"	35	50	85	120	150 <sup>1)</sup>	150 <sup>2)</sup>	150 <sup>2)</sup>
	45	–	85	120	150 <sup>1)</sup>	150 <sup>2)</sup>	150 <sup>2)</sup>
	50	–	–	120	150 <sup>1)</sup>	150 <sup>2)</sup>	150 <sup>2)</sup>

- 1) The following applies for specified sensors with a maximum medium temperature  $T_m = 205$  °C:  $T_m = 170$  °C  
2) The following applies for specified sensors with a maximum medium temperature  $T_m = 205$  °C:  $T_m = 205$  °C

##### US units

Order code for "Housing"	$T_a$ [°F]	T6 [185 °F]	T5 [212 °F]	T4 [275 °F]	T3 [392 °F]	T2 [572 °F]	T1 [842 °F]
Option A "Compact coated alu" Option B "Compact, stainless"	95	122	185	248	302 <sup>1)</sup>	302 <sup>2)</sup>	302 <sup>2)</sup>
	122	–	185	248	302 <sup>1)</sup>	302 <sup>2)</sup>	302 <sup>2)</sup>
	140	–	–	248	302 <sup>1)</sup>	302 <sup>2)</sup>	302 <sup>2)</sup>
Option C "Ultra-compact, stainless"	95	122	185	248	302 <sup>1)</sup>	302 <sup>2)</sup>	302 <sup>2)</sup>
	113	–	185	248	302 <sup>1)</sup>	302 <sup>2)</sup>	302 <sup>2)</sup>
	122	–	–	248	302 <sup>1)</sup>	302 <sup>2)</sup>	302 <sup>2)</sup>

- 1) The following applies for specified sensors with a maximum medium temperature  $T_m = 401$  °F:  $T_m = 338$  °F  
2) The following applies for specified sensors with a maximum medium temperature  $T_m = 401$  °F:  $T_m = 401$  °F



Ex nA, cCSA<sub>US</sub> NI

SI units

Order code for "Housing"	T <sub>a</sub> [°C]	T6 [85 °C]	T5 [100 °C]	T4 [135 °C]	T3 [200 °C]	T2 [300 °C]	T1 [450 °C]
Option A "Compact coated alu"	35	50	85	120	150 <sup>1)</sup>	150 <sup>2)</sup>	150
	50	-	85	120	150	150	150
Option B "Compact, stainless"	60	-	-	120	150	150	150
Option C "Ultra-compact, stainless"	50	-	85	120	150	150	150
	60	-	-	120	150	150	150

- 1) The following applies for specified sensors with a maximum medium temperature T<sub>m</sub> = 205 °C: T<sub>m</sub> = 170 °C
- 2) The following applies for specified sensors with a maximum medium temperature T<sub>m</sub> = 205 °C: T<sub>m</sub> = 205 °C

US units

Order code for "Housing"	T <sub>a</sub> [°F]	T6 [185 °F]	T5 [212 °F]	T4 [275 °F]	T3 [392 °F]	T2 [572 °F]	T1 [842 °F]
Option A "Compact coated alu"	95	122	185	248	302 <sup>1)</sup>	302 <sup>2)</sup>	302
	122	-	185	248	302	302	302
Option B "Compact, stainless"	140	-	-	248	302	302	302
Option C "Ultra-compact, stainless"	122	-	185	248	302	302	302
	140	-	-	248	302	302	302

- 1) The following applies for specified sensors with a maximum medium temperature T<sub>m</sub> = 401 °F: T<sub>m</sub> = 338 °F
- 2) The following applies for specified sensors with a maximum medium temperature T<sub>m</sub> = 401 °F: T<sub>m</sub> = 401 °F

Explosion hazards arising from gas and dust

Determining the temperature class and surface temperature with the temperature table

- In the case of gas: Determine the temperature class as a function of the ambient temperature T<sub>a</sub> and the medium temperature T<sub>m</sub>.
- In the case of dust: Determine the maximum surface temperature as a function of the maximum ambient temperature T<sub>a</sub> and the maximum medium temperature T<sub>m</sub>.

Example

- Measured maximum ambient temperature: T<sub>ma</sub> = 47 °C
- Measured maximum medium temperature: T<sub>mm</sub> = 108 °C



	T <sub>a</sub> [°C]	T6 [85 °C]	T5 [100 °C]	T4 [135 °C]	T3 [200 °C]	T2 [300 °C]	T1 [450 °C]
1.	35	50	85	120	140	140	140
	50	-	85	120	140	140	140
	60	-	-	120	140	140	140
	35	50	85	120	140	140	140
	45	-	85	120	140	140	140
	50	-	-	120	140	140	140

A0019758

22 Procedure for determining the maximum surface temperature

- 1. Select device (optional).

2. In the column for the maximum ambient temperature  $T_a$  select the temperature that is immediately greater than or equal to the measured maximum ambient temperature  $T_{ma}$  that is present.
  - ↳  $T_a = 50\text{ °C}$ .  
The row showing the maximum medium temperature is determined.
3. Select the maximum medium temperature  $T_m$  of this row, which is larger or equal to the measured maximum medium temperature  $T_{mm}$ .
  - ↳ The column with the temperature class for gas is determined:  $108\text{ °C} \leq 120\text{ °C} \rightarrow T4$ .
4. The maximum temperature of the temperature class determined corresponds to the maximum surface temperature for dust:  $T4 = 135\text{ °C}$

<b>Storage temperature</b>	-40 to +80 °C (-40 to +176 °F), preferably at +20 °C (+68 °F) (standard version) -50 to +80 °C (-58 to +176 °F) (Order code for "Test, certificate", option JM)
<b>Climate class</b>	DIN EN 60068-2-38 (test Z/AD)
<b>Degree of protection</b>	<p><b>Transmitter and sensor</b></p> <ul style="list-style-type: none"> <li>■ As standard: IP66/67, type 4X enclosure</li> <li>■ With the order code for "Sensor options", option <b>CM</b>: IP69K can also be ordered</li> <li>■ When housing is open: IP20, type 1 enclosure</li> <li>■ Display module: IP20, type 1 enclosure</li> </ul> <p><b>Safety Barrier Promass 100</b> IP20</p>
<b>Vibration resistance</b>	<p><b>Compact version</b></p> <ul style="list-style-type: none"> <li>■ Vibration, sinusoidal according to IEC 60068-2-6           <ul style="list-style-type: none"> <li>- 2 to 8.4 Hz, 3.5 mm peak</li> <li>- 8.4 to 2 000 Hz, 1 g peak</li> </ul> </li> <li>■ Vibration broad-band random, according to IEC 60068-2-64           <ul style="list-style-type: none"> <li>- 10 to 200 Hz, 0.003 g<sup>2</sup>/Hz</li> <li>- 200 to 2 000 Hz, 0.001 g<sup>2</sup>/Hz</li> <li>- Total: 1.54 g rms</li> </ul> </li> </ul>
<b>Shock resistance</b>	<p><b>Compact version</b></p> <p>Shock, half-sine according to IEC 60068-2-27 6 ms 30 g</p>
<b>Shock resistance</b>	<p><b>Compact version</b></p> <p>Rough handling shocks according to IEC 60068-2-31</p>
<b>Interior cleaning</b>	<ul style="list-style-type: none"> <li>■ Cleaning in place (CIP)</li> <li>■ Sterilization in place (SIP)</li> </ul> <p><b>Options</b></p> <p>Oil- and grease-free version for wetted parts, without inspection certificate Order code for "Service", option <b>HA</b></p>
<b>Electromagnetic compatibility (EMC)</b>	<ul style="list-style-type: none"> <li>■ Depends on the communication protocol:           <ul style="list-style-type: none"> <li>- HART, PROFIBUS DP, Modbus RS485, EtherNet/IP: As per IEC/EN 61326 and NAMUR Recommendation 21 (NE 21)</li> <li>- PROFINET: as per IEC/EN 61326</li> </ul> </li> <li>■ Complies with emission limits for industry as per EN 55011 (Class A)</li> <li>■ Device version with PROFIBUS DP: Complies with emission limits for industry as per EN 50170 Volume 2, IEC 61784</li> </ul> <p> The following applies for PROFIBUS DP: If baud rates &gt; 1.5 MBaud, an EMC cable entry must be used and the cable shield must continue as far as the terminal wherever possible.</p> <p> For details, refer to the Declaration of Conformity.</p>

## Process

**Medium temperature range**

**Sensor**

- Zirconium 702/R 60702: -50 to +205 °C (-58 to +401 °F)
- Tantalum 2.5W: -50 to +150 °C (-58 to +302 °F)

**Seals**

No internal seals

**Density**

0 to 5 000 kg/m<sup>3</sup> (0 to 312 lb/cf)

**Pressure-temperature ratings**

The following pressure-temperature ratings refer to the entire device and not just the process connection.

**Flange connection according to EN 1092-1 (DIN 2501)**

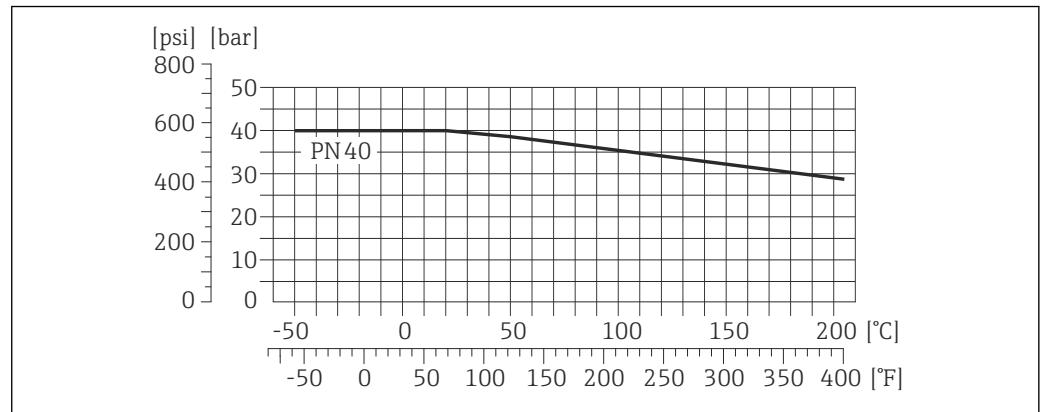

A0027769-EN

23 With flange material 1.4301 (304); wetted parts: zirconium 702, tantalum

The material load curves for the temperature range +150 to +205 °C (+302 to +401 °F) apply only to the order code for "Measuring tube material", option TJ

**Flange connection according to ASME B16.5**

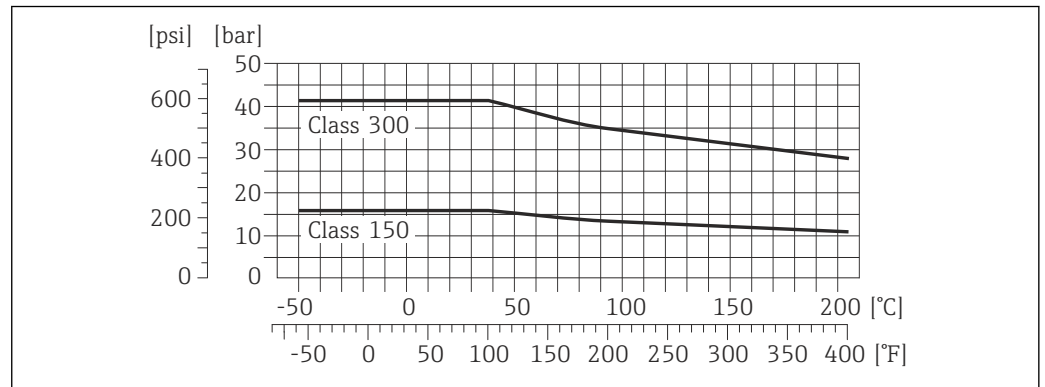

A0027771-EN

24 With flange material 1.4301 (304); wetted parts: zirconium 702, tantalum

The material load curves for the temperature range +150 to +205 °C (+302 to +401 °F) apply only to the order code for "Measuring tube material", option TJ

### Flange connection according to JIS B2220

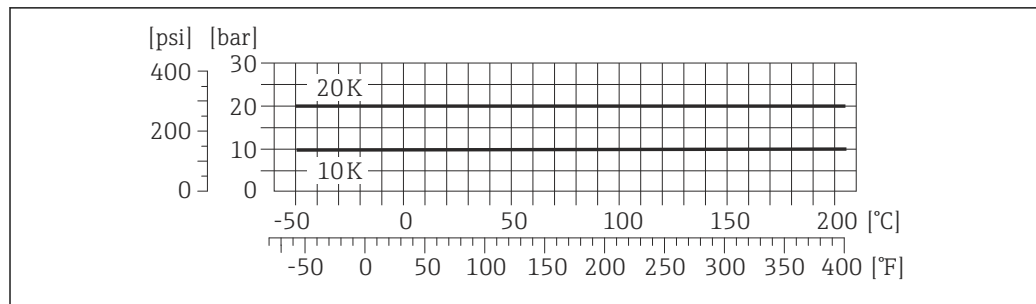

A0027772-EN

25 With flange material 1.4301 (304); wetted parts: zirconium 702, tantalum

The material load curves for the temperature range +150 to +205 °C (+302 to +401 °F) apply only to the order code for "Measuring tube material", option TJ

### Secondary containment pressure rating

The sensor housing is filled with dry nitrogen and protects the electronics and mechanics inside.

The following secondary containment pressure rating is only valid for a fully welded sensor housing and/or a device equipped with closed purge connections (never opened/as delivered).

DN		Secondary containment pressure rating (designed with a safety factor $\geq 4$ )		Secondary containment burst pressure	
[mm]	[in]	[bar]	[psi]	[bar]	[psi]
8	$\frac{3}{8}$	25	362	170	2465
15	$\frac{1}{2}$	25	362	160	2320
25	1	25	362	130	1885
40	$1\frac{1}{2}$	16	232	85	1200
50	2	16	232	85	1200

**i** If there is a risk of measuring tube failure due to process characteristics, e.g. with corrosive fluids, we recommend the use of sensors whose secondary containment is equipped with special pressure monitoring connections (order code for "Sensor option", option CH "Purge connection").

With the help of these connections, the fluid collected in the secondary containment can be bled off in the event of tube failure. This is especially important in high-pressure gas applications. These connections can also be used for gas purging (gas detection).

Do not open the purge connections unless the containment can be filled immediately with a dry, inert gas. Use only low gauge pressure to purge. Maximum pressure: 5 bar (72.5 psi).

If a device fitted with purge connections is connected to the purge system, the maximum nominal pressure is determined by the purge system itself or by the device, depending on which component has the lower nominal pressure.

Dimensions:



### Flow limit

Select the nominal diameter by optimizing between the required flow range and permissible pressure loss.

**i** For an overview of the full scale values for the measuring range, see the "Measuring range" section

- The minimum recommended full scale value is approx. 1/20 of the maximum full scale value
- In most applications, 20 to 50 % of the maximum full scale value can be considered ideal
- A low full scale value must be selected for abrasive media (such as liquids with entrained solids): flow velocity < 1 m/s (< 3 ft/s).
- For gas measurement the following rules apply:
  - The flow velocity in the measuring tubes should not exceed half the sound velocity (0.5 Mach)
  - The maximum mass flow depends on the density of the gas: formula

**Pressure loss**

 To calculate the pressure loss, use the *Applicator* sizing tool →  76

**System pressure**

It is important that cavitation does not occur, or that gases entrained in the liquids do not outgas. This is prevented by means of a sufficiently high system pressure.

For this reason, the following mounting locations are recommended:

- At the lowest point in a vertical pipe
- Downstream from pumps (no danger of vacuum)

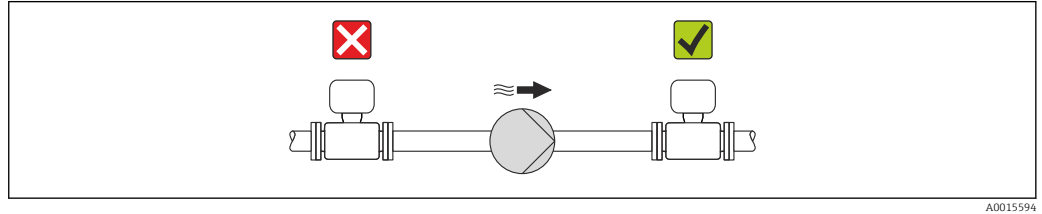

A001594

**Thermal insulation**

In the case of some fluids, it is important that the heat radiated from the sensor to the transmitter is kept to a minimum. A wide range of materials can be used for the required insulation.

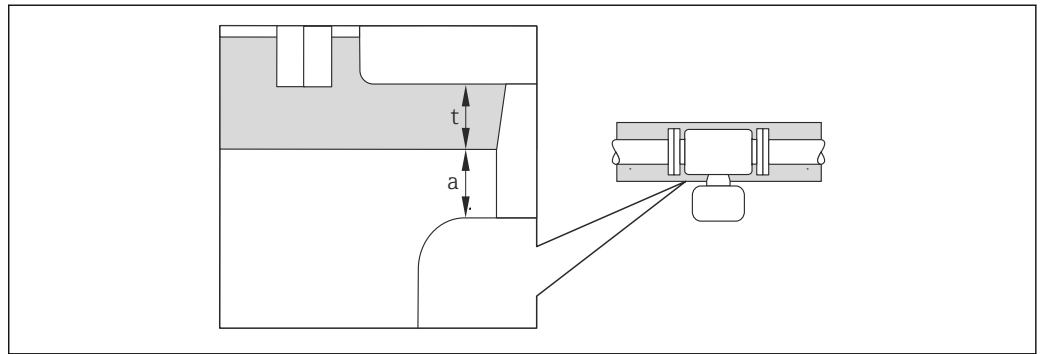

A0019919

- a* Minimum distance to insulation
- t* maximum Insulation thickness

The minimum distance between the transmitter housing and the insulation is 10 mm (0.39 in) so that the transmitter head remains completely exposed.

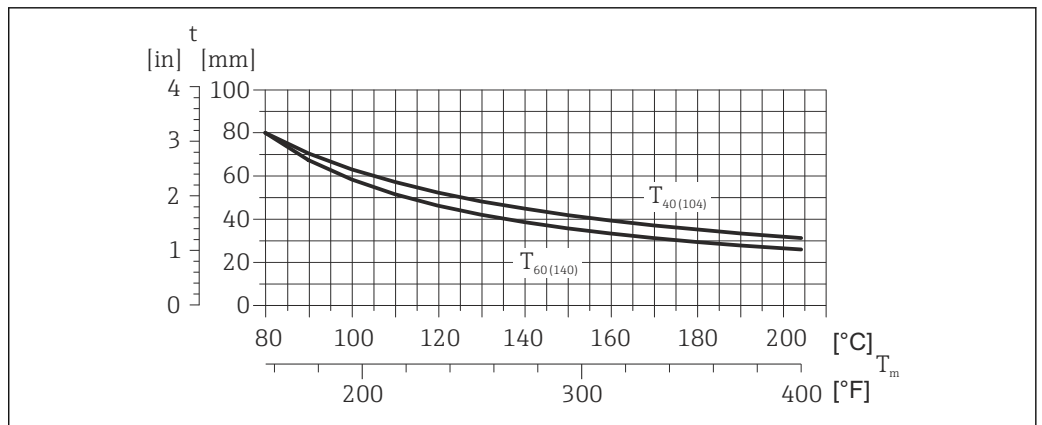

A0023177

 26 Maximum recommended insulation thickness depending on the temperature of the medium and the ambient temperature

- t* Insulation thickness
- $T_m$  Medium temperature
- $T_{40(104)}$  Maximum recommended insulation thickness at an ambient temperature of  $T_a = 40$  °C (104 °F)
- $T_{60(140)}$  Maximum recommended insulation thickness at an ambient temperature of  $T_a = 60$  °C (140 °F)

**NOTICE****Danger of overheating with insulation**

- ▶ Ensure that the temperature at the lower end of the transmitter housing does not exceed 80 °C (176 °F)

**NOTICE****The insulation can also be thicker than the maximum recommended insulation thickness.**

Prerequisite:

- ▶ Ensure that convection takes place on a sufficiently large scale at the transmitter neck.
- ▶ Ensure that a sufficiently large area of the housing support remains exposed. The uncovered part serves as a radiator and protects the electronics from overheating and excessive cooling.

---

**Heating**

Some fluids require suitable measures to avoid loss of heat at the sensor.

**Heating options**

- Electrical heating, e.g. with electric band heaters
- Via pipes carrying hot water or steam
- Via heating jackets



Heating jackets for the sensors can be ordered as accessories from Endress+Hauser →  75.

**NOTICE****Danger of overheating when heating**

- ▶ Ensure that the temperature at the lower end of the transmitter housing does not exceed 80 °C (176 °F).
- ▶ Ensure that convection takes place on a sufficiently large scale at the transmitter neck.
- ▶ Ensure that a sufficiently large area of the housing support remains exposed. The uncovered part serves as a radiator and protects the electronics from overheating and excessive cooling.

---

**Vibrations**

The high oscillation frequency of the measuring tubes ensures that the correct operation of the measuring system is not influenced by plant vibrations.

## Mechanical construction

Dimensions in SI units

Compact version

Order code for "Housing", option A "Compact coated alu"

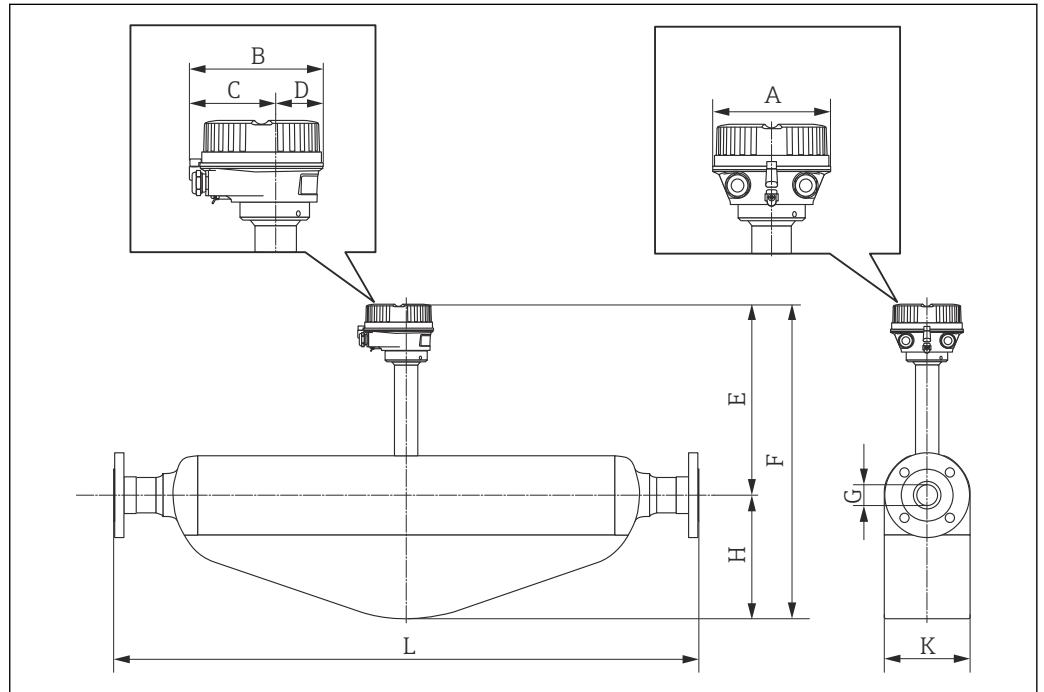

A0019436

DN [mm]	A [mm]	B [mm]	C [mm]	D [mm]	E <sup>1)</sup> [mm]	F <sup>1)</sup> [mm]	G [mm]	H [mm]	L [mm]	K [mm]
8	136	147.5	93.5	54	261	369	8.51	108	<sup>2)</sup>	92
15	136	147.5	93.5	54	261	369	12.0	108	<sup>2)</sup>	92
25	136	147.5	93.5	54	261	382	17.6	121	<sup>2)</sup>	92
40	136	147.5	93.5	54	285	458	25.5	173	<sup>2)</sup>	132
50	136	147.5	93.5	54	296	537	40.5	241	<sup>2)</sup>	167

- 1) If using a display, order code for "Display; Operation", option B: values + 28 mm
- 2) Dependent on the specific process connection

Order code for "Housing", option B "Compact hygienic, stainless"

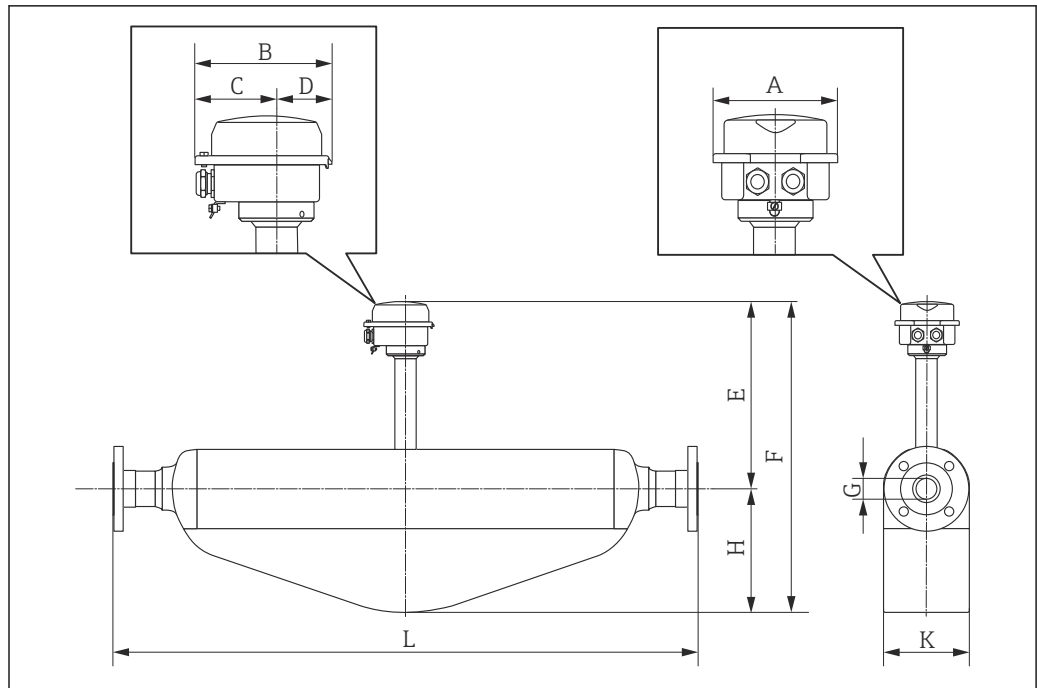

A0019437

DN [mm]	A [mm]	B [mm]	C [mm]	D [mm]	E <sup>1)</sup> [mm]	F <sup>1)</sup> [mm]	G [mm]	H [mm]	L [mm]	K [mm]
8	133.5	136.8	78	58.8	257	365	8.51	108	<sup>2)</sup>	92
15	133.5	136.8	78	58.8	257	365	12.0	108	<sup>2)</sup>	92
25	133.5	136.8	78	58.8	257	378	17.6	121	<sup>2)</sup>	92
40	133.5	136.8	78	58.8	281	454	25.5	173	<sup>2)</sup>	132
50	133.5	136.8	78	58.8	292	533	40.5	241	<sup>2)</sup>	167

- 1) If using a display, order code for "Display; Operation", option B: values + 14 mm
- 2) Dependent on the specific process connection



Order code for "Housing", option C "Ultra-compact hygienic, stainless"

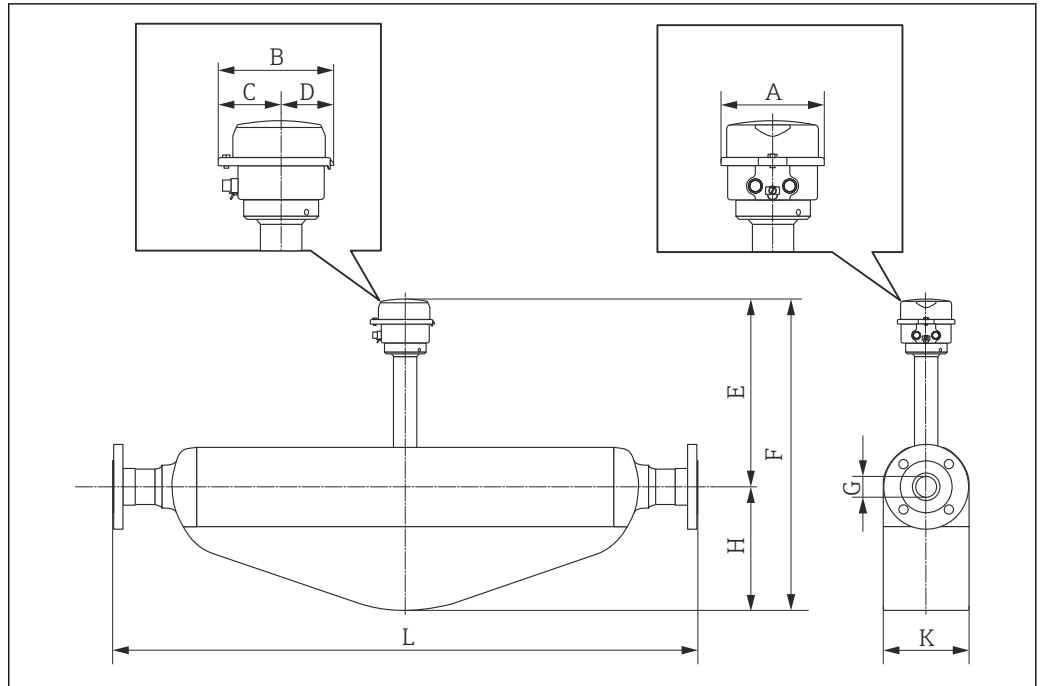

A0019438

DN [mm]	A [mm]	B [mm]	C [mm]	D [mm]	E <sup>1)</sup> [mm]	F <sup>1)</sup> [mm]	G [mm]	H [mm]	L [mm]	K [mm]
8	114.9	123.6	67.7	55.9	256	364	8.51	108	<sup>2)</sup>	92
15	114.9	123.6	67.7	55.9	256	364	12.0	108	<sup>2)</sup>	92
25	114.9	123.6	67.7	55.9	256	377	17.6	121	<sup>2)</sup>	92
40	114.9	123.6	67.7	55.9	280	453	25.5	173	<sup>2)</sup>	132
50	114.9	123.6	67.7	55.9	291	532	40.5	241	<sup>2)</sup>	167

- 1) If using a display, order code for "Display; Operation", option B: values + 14 mm
- 2) Dependent on the specific process connection

**Flange connections**

Fixed flange EN 1092-1, ASME B16.5, JIS B2220

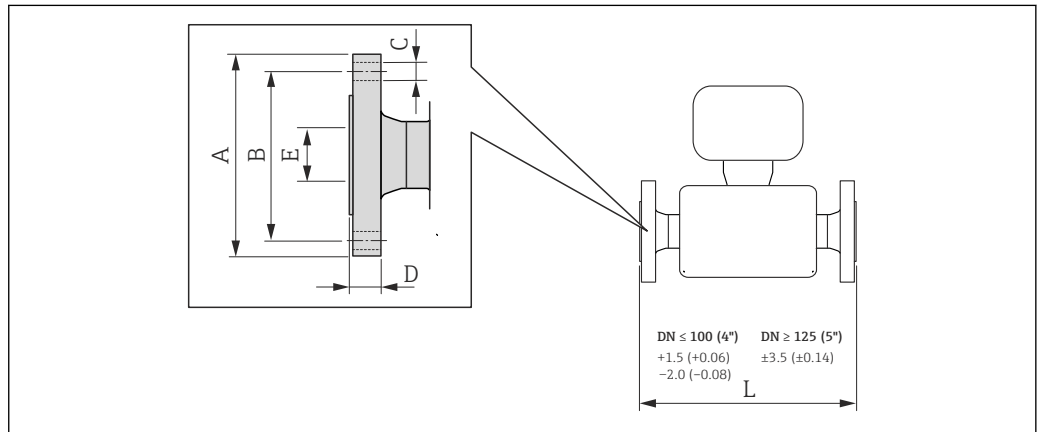

A0015621

27 Engineering unit mm (in)

<b>Flange according to EN 1092-1 (DIN 2501): PN 40 1.4404 (316/316L)</b>						
<i>Order code for "Process connection", option D2W</i>						
<b>DN [mm]</b>	<b>A [mm]</b>	<b>B [mm]</b>	<b>C [mm]</b>	<b>D [mm]</b>	<b>E [mm]</b>	<b>L [mm]</b>
8 <sup>1)</sup>	95	65	4 × Ø14	20	17.3	336
15	95	65	4 × Ø14	20	17.3	440
25	115	85	4 × Ø14	19.0	28.5	580
40	150	110	4 × Ø18	21.5	43.1	794
50	165	125	4 × Ø18	23.5	54.5	1071
Surface roughness (flange): EN 1092-1 Form B1 (DIN 2526 Form C), Ra 3.2 to 12.5 µm						

1) DN 8 with DN 15 flanges as standard

<b>Flange according to ASME B16.5: Cl 150 1.4404 (316/316L)</b>						
<i>Order code for "Process connection", option AAW</i>						
<b>DN [mm]</b>	<b>A [mm]</b>	<b>B [mm]</b>	<b>C [mm]</b>	<b>D [mm]</b>	<b>E [mm]</b>	<b>L [mm]</b>
8 <sup>1)</sup>	90	60.3	4 × Ø15.7	12.8	15.7	336
15	90	60.3	4 × Ø15.7	12.8	15.7	440
25	110	79.4	4 × Ø15.7	15.1	26.7	580
40	125	98.4	4 × Ø15.7	17.5	40.9	794
50	150	120.7	4 × Ø19.1	23.6	52.6	1071
Surface roughness (flange): Ra 3.2 to 6.3 µm						

1) DN 8 with DN 15 flanges as standard

<b>Flange according to ASME B16.5: Cl 300 1.4404 (316/316L)</b>						
<i>Order code for "Process connection", option ABW</i>						
<b>DN [mm]</b>	<b>A [mm]</b>	<b>B [mm]</b>	<b>C [mm]</b>	<b>D [mm]</b>	<b>E [mm]</b>	<b>L [mm]</b>
8 <sup>1)</sup>	95	66.7	4 × Ø15.7	14.2	15.7	336
15	95	66.7	4 × Ø15.7	14.2	15.7	440
25	125	88.9	4 × Ø19.1	17.5	26.7	580
40	155	114.3	4 × Ø22.3	20.6	40.9	794
50	165	127.0	8 × Ø19.1	23.6	52.6	1071
Surface roughness (flange): Ra 3.2 to 6.3 µm						

1) DN 8 with DN 15 flanges as standard

<b>Flange JIS B2220: 20K 1.4404 (316/316L)</b>						
<i>Order code for "Process connection", option NEW</i>						
<b>DN [mm]</b>	<b>A [mm]</b>	<b>B [mm]</b>	<b>C [mm]</b>	<b>D [mm]</b>	<b>E [mm]</b>	<b>L [mm]</b>
8 <sup>1)</sup>	95	70	4 × Ø15	14	15	336
15	95	70	4 × Ø15	14	15	440
25	125	90	4 × Ø19	16	25	580

**Flange JIS B2220: 20K**  
**1.4404 (316/316L)**  
*Order code for "Process connection", option NEW*

DN [mm]	A [mm]	B [mm]	C [mm]	D [mm]	E [mm]	L [mm]
40	140	105	4 × Ø19	18	40	794
50	165	120	8 × Ø19	22	50	1071

Surface roughness (flange): Ra 3.2 to 6.3 µm

1) DN 8 with DN 15 flanges as standard

**Safety Barrier Promass 100**

Top-hat rail EN 60715:

- TH 35 x 7.5
- TH 35 x 15

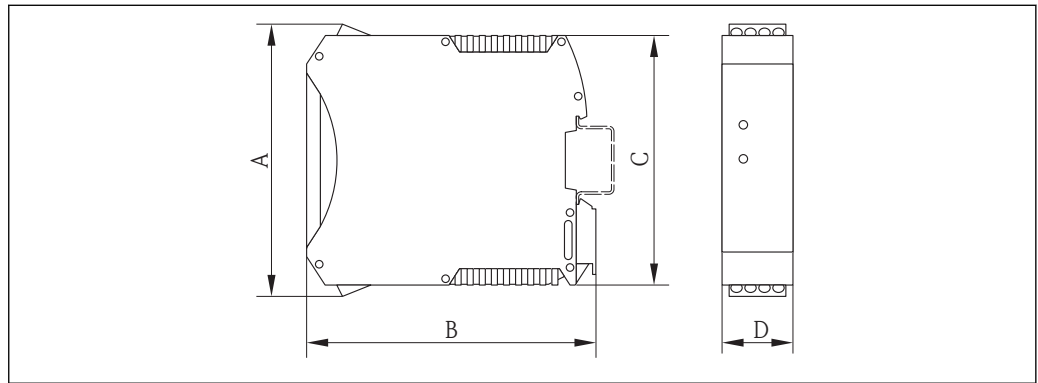

A0016777

A [mm]	B [mm]	C [mm]	D [mm]
108	114.5	99	22.5

**Accessories**

*Purge connections / secondary containment monitoring*

Order code for "Sensor options", option CH

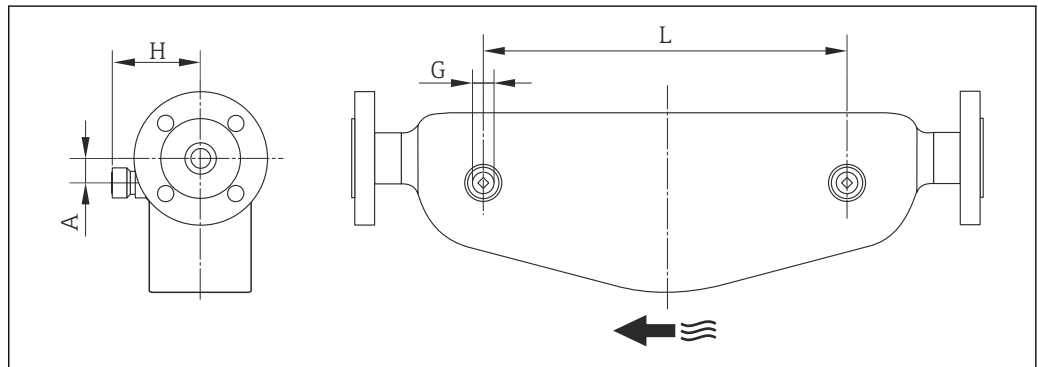

A0003288

DN	G	A	H	L
[mm]	[in]	[mm]	[mm]	[mm]
8	½ NPT	25	82	110
15	½ NPT	25	82	204
25	½ NPT	25	82	348
40	½ NPT	45	102	526
50	½ NPT	58	119.5	763

## Dimensions in US units

## Compact version

Order code for "Housing", option A "Compact coated alu"

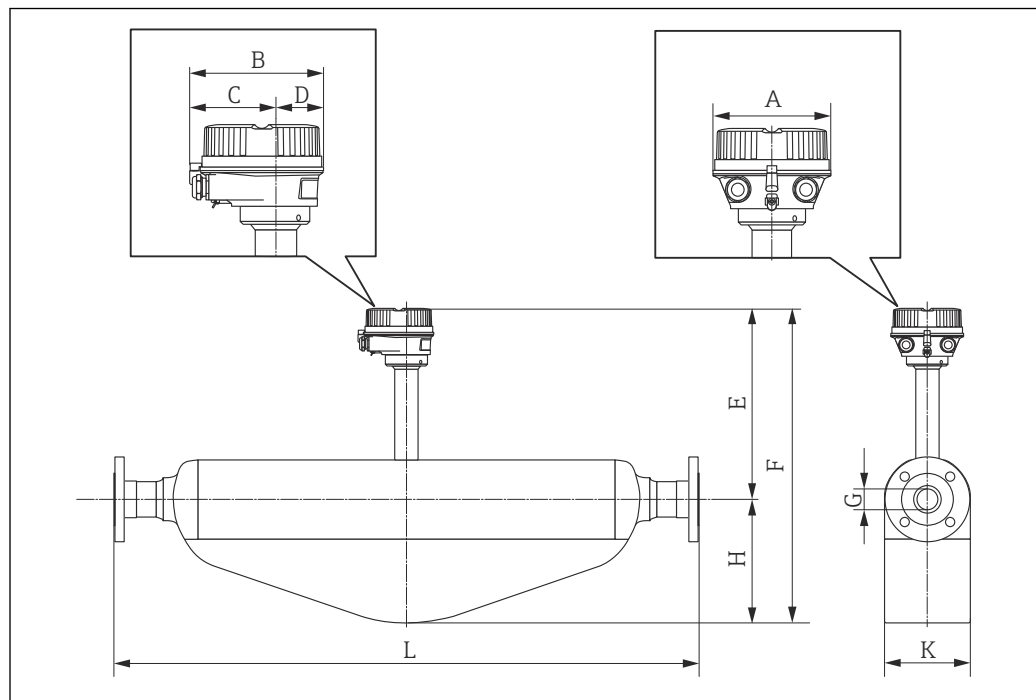

DN [in]	A [in]	B [in]	C [in]	D [in]	E <sup>1)</sup> [in]	F <sup>1)</sup> [in]	G [in]	H [in]	L [in]	K [in]
¾	5.35	5.81	3.68	2.13	10.3	14.5	0.34	4.25	<sup>2)</sup>	3.62
½	5.35	5.81	3.68	2.13	10.3	14.5	0.47	4.25	<sup>2)</sup>	3.62
1	5.35	5.81	3.68	2.13	10.3	15.0	0.69	4.76	<sup>2)</sup>	3.62
1½	5.35	5.81	3.68	2.13	11.2	18.0	1	6.81	<sup>2)</sup>	5.2
2	5.35	5.81	3.68	2.13	11.7	21.1	1.59	9.49	<sup>2)</sup>	6.57

- 1) If using a display, order code for "Display; Operation", option B: values + 1.1 in  
 2) Dependent on the specific process connection

Order code for "Housing", option B "Compact hygienic, stainless"

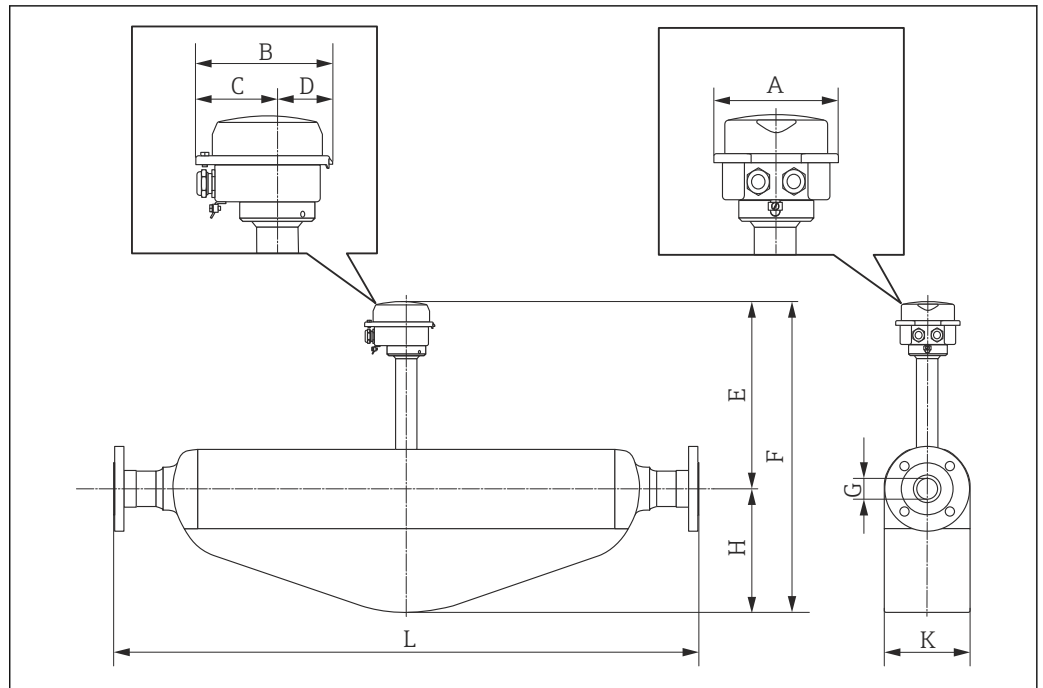

A0019437

DN [in]	A [in]	B [in]	C [in]	D [in]	E <sup>1)</sup> [in]	F <sup>1)</sup> [in]	G [in]	H [in]	L [in]	K [in]
3/8	5.26	5.39	3.07	2.31	10.1	14.4	0.34	4.25	<sup>2)</sup>	3.62
1/2	5.26	5.39	3.07	2.31	10.1	14.4	0.47	4.25	<sup>2)</sup>	3.62
1	5.26	5.39	3.07	2.31	10.1	14.9	0.69	4.76	<sup>2)</sup>	3.62
1 1/2	5.26	5.39	3.07	2.31	11.1	17.9	1	6.81	<sup>2)</sup>	5.2
2	5.26	5.39	3.07	2.31	11.5	21.0	1.59	9.49	<sup>2)</sup>	6.57

- 1) If using a display, order code for "Display; Operation", option B: values + 0.55 in
- 2) Dependent on the specific process connection

Order code for "Housing", option C "Ultra-compact hygienic, stainless"

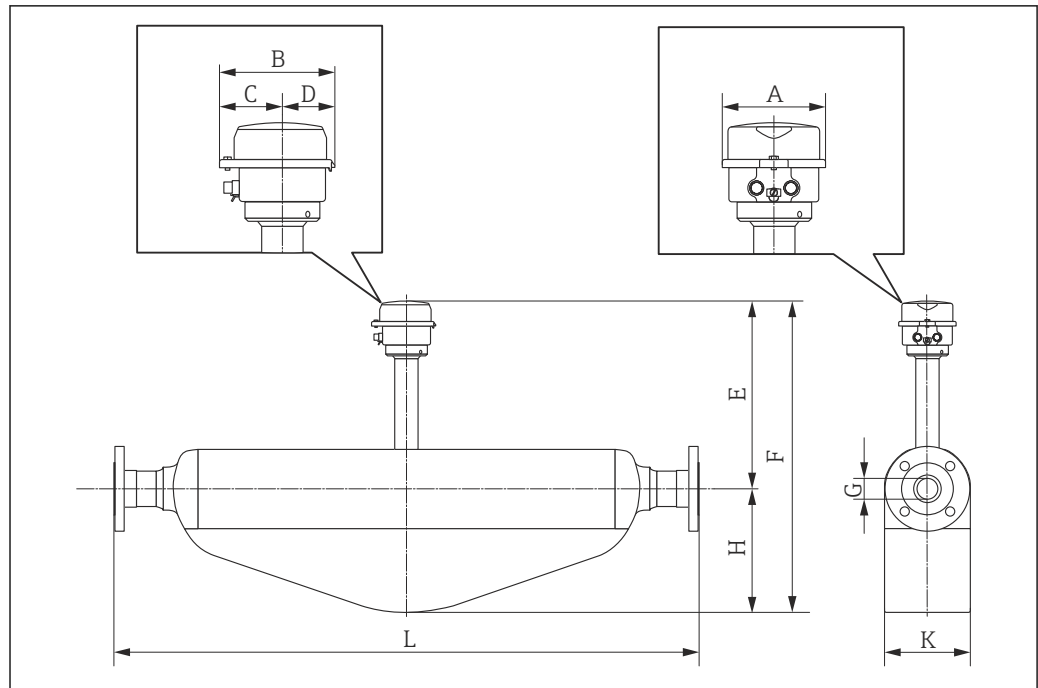

A0019438

DN [in]	A [in]	B [in]	C [in]	D [in]	E <sup>1)</sup> [in]	F <sup>1)</sup> [in]	G [in]	H [in]	L [in]	K [in]
3/8	4.39	4.87	2.67	2.2	10.1	14.3	0.34	4.25	<sup>2)</sup>	3.62
1/2	4.39	4.87	2.67	2.2	10.1	14.3	0.47	4.25	<sup>2)</sup>	3.62
1	4.39	4.87	2.67	2.2	10.1	14.8	0.69	4.76	<sup>2)</sup>	3.62
1 1/2	4.39	4.87	2.67	2.2	11.0	17.8	1	6.81	<sup>2)</sup>	5.2
2	4.39	4.87	2.67	2.2	11.5	20.9	1.59	9.49	<sup>2)</sup>	6.57

- 1) If using a display, order code for "Display; Operation", option B: values + 0.55 in
- 2) Dependent on the specific process connection

### Flange connections

Fixed flange ASME B16.5

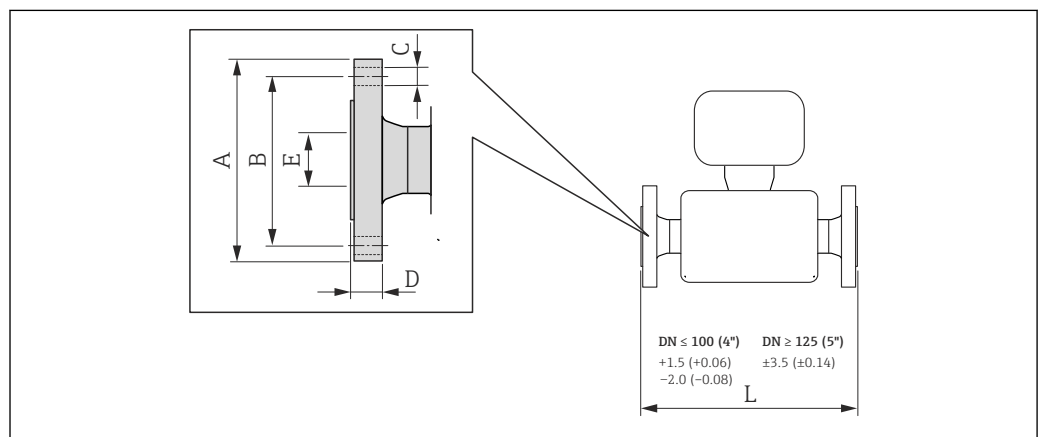

DN ≤ 100 (4")    DN ≥ 125 (5")  
 +1.5 (+0.06)    ±3.5 (±0.14)  
 -2.0 (-0.08)

A0015621

28 Engineering unit mm (in)

Flange according to ASME B16.5: Cl 150 1.4404 (316/316L) Order code for "Process connection", option AAW						
DN [in]	A [in]	B [in]	C [in]	D [in]	E [in]	L [in]
$\frac{3}{8}$ <sup>1)</sup>	3.54	2.37	4 × Ø0.62	0.50	0.62	13.23
$\frac{1}{2}$	3.54	2.37	4 × Ø0.62	0.50	0.62	17.32
1	4.33	3.13	4 × Ø0.62	0.59	1.05	22.83
1½	4.92	3.87	4 × Ø0.62	0.69	1.61	31.26
2	5.91	4.75	4 × Ø0.75	0.93	2.07	42.17
Surface roughness (flange): Ra 125 to 248 µin						

1) DN  $\frac{3}{8}$ " with DN  $\frac{1}{2}$ " flanges as standard

Flange according to ASME B16.5: Cl 300 1.4404 (316/316L) Order code for "Process connection", option ABW						
DN [in]	A [in]	B [in]	C [in]	D [in]	E [in]	L [in]
$\frac{3}{8}$ <sup>1)</sup>	3.74	2.63	4 × Ø0.62	0.56	0.62	13.23
$\frac{1}{2}$	3.74	2.63	4 × Ø0.62	0.56	0.62	17.32
1	4.92	3.50	4 × Ø0.75	0.69	1.05	22.83
1½	6.10	4.50	4 × Ø0.88	0.81	1.61	31.26
2	6.50	5.00	8 × Ø0.75	0.93	2.07	42.17
Surface roughness (flange): Ra 125 to 248 µin						

1) DN  $\frac{3}{8}$ " with DN  $\frac{1}{2}$ " flanges as standard

**Safety Barrier Promass 100**

Top-hat rail EN 60715:

- TH 35 x 7.5
- TH 35 x 15

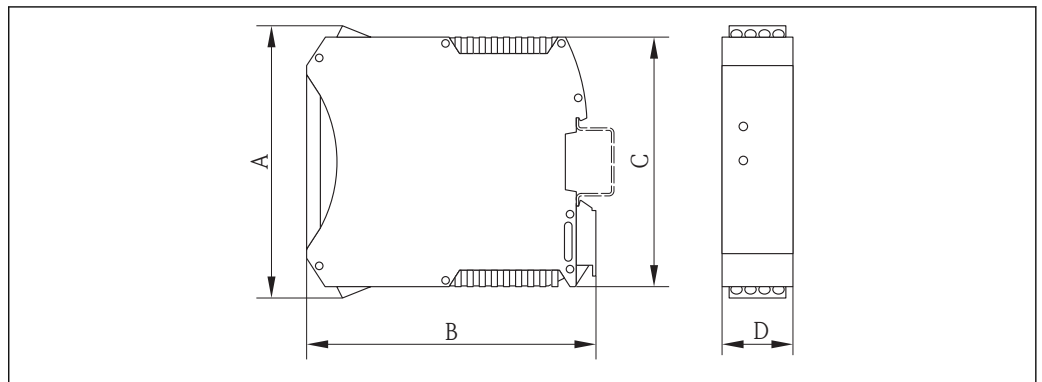

A0016777

A	B	C	D
[in]	[in]	[in]	[in]
4.25	4.51	3.9	0.89

**Accessories**

*Purge connections / secondary containment monitoring*

Order code for "Sensor options", option CH

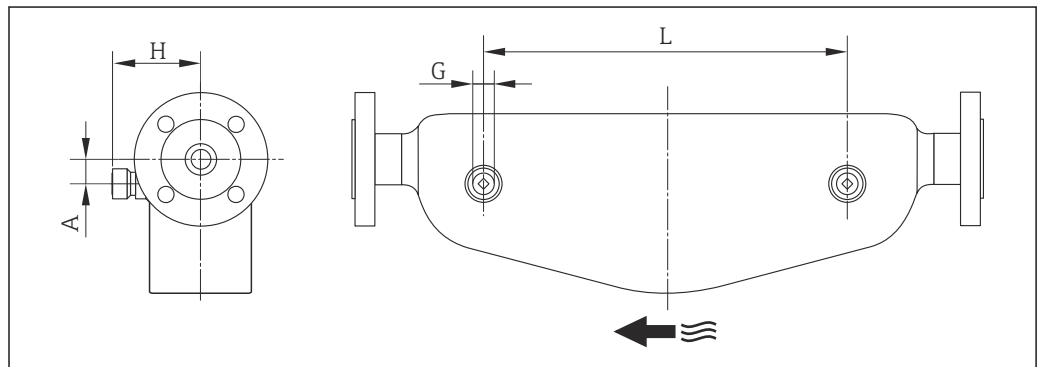

A0003288

DN	G	A	H	L
[in]	[in]	[in]	[in]	[in]
3/8	1/2 NPT	0.98	3.23	4.34
1/2	1/2 NPT	0.98	3.23	8.04
1	1/2 NPT	0.98	3.23	13.54
1 1/2	1/2 NPT	1.77	4.02	20.70
2	1/2 NPT	2.28	4.70	30.04

**Weight**

**Compact version**

*Weight in SI units*

All values (weight) refer to devices with EN/DIN PN 40 flanges. Weight information in [kg].

DN [mm]	Weight [kg]
8	10
15	11
25	17
40	34
50	67

*Weight in US units*

All values (weight) refer to devices with EN/DIN PN 40 flanges. Weight information in [lbs].

DN [in]	Weight [lbs]
3/8	22
1/2	24
1	37
1 1/2	75
2	148



**Safety Barrier Promass 100**

49 g (1.73 ounce)

**Materials**

**Transmitter housing**

- Order code for "Housing", option **A** "Compact, aluminum coated":  
Aluminum, AlSi10Mg, coated
- Order code for "Housing", option **B** "Compact, stainless":  
Stainless steel 1.4301 (304)
- Order code for "Housing", option **C** "Ultra-compact, stainless":  
Stainless steel 1.4301 (304)
- Window material for optional local display (→ ☰ 67):
  - For order code for "Housing", option **A**: glass
  - For order code for "Housing", option **B** and **C**: plastic

**Cable entries/cable glands**

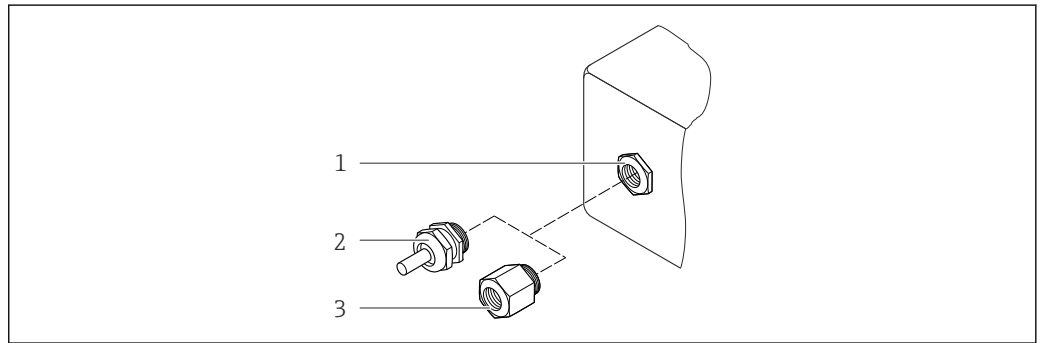

☰ 29 Possible cable entries/cable glands

- 1 Cable entry in transmitter housing with internal thread M20 x 1.5
- 2 Cable gland M20 x 1.5
- 3 Adapter for cable entry with internal thread G ½" or NPT ½"

Order code for "Housing", option **A** "Compact, coated aluminum"

The various cable entries are suitable for hazardous and non-hazardous areas.

Cable entry/cable gland	Material
Cable gland M20 × 1.5	Nickel-plated brass
Adapter for cable entry with internal thread G ½"	
Adapter for cable entry with internal thread NPT ½"	

Order code for "Housing", option **B** "Compact, stainless"

The various cable entries are suitable for hazardous and non-hazardous areas.

Cable entry/cable gland	Material
Cable gland M20 × 1.5	Stainless steel, 1.4404 (316L)
Adapter for cable entry with internal thread G ½"	
Adapter for cable entry with internal thread NPT ½"	

**Device plug**

Electrical connection	Material
Plug M12x1	<ul style="list-style-type: none"> <li>▪ Socket: Stainless steel, 1.4404 (316L)</li> <li>▪ Contact housing: Polyamide</li> <li>▪ Contacts: Gold-plated brass</li> </ul>

**Sensor housing**

- Acid and alkali-resistant outer surface
- Stainless steel 1.4301 (304)

**Measuring tubes**

- Zirconium 702/R 60702
- Tantalum 2.5W

**Process connections**

- Stainless steel, 1.4301 (304); wetted parts: zirconium 702, tantalum
- Flanges according to EN 1092-1 (DIN 2501) / according to ASME B16.5 / according to JIS B2220



List of all available process connections → 66

**Seals**

Welded process connections without internal seals

**Safety Barrier Promass 100**

Housing: Polyamide

**Process connections**

Fixed flange connections:

- EN 1092-1 (DIN 2501) flange
- EN 1092-1 (DIN 2512N) flange
- ASME B16.5 flange
- JIS B2220 flange



For information on the different materials used in the process connections → 65

**Surface roughness**

All data relate to parts in contact with fluid.  
Not polished

## Operability

**Operating concept****Operator-oriented menu structure for user-specific tasks**

- Commissioning
- Operation
- Diagnostics
- Expert level

**Quick and safe commissioning**

- Individual menus for applications
- Menu guidance with brief explanations of the individual parameter functions

**Reliable operation**

- Operation in the following languages:
  - Via "FieldCare" operating tool: English, German, French, Spanish, Italian, Chinese, Japanese
  - Via integrated Web browser (only available for device versions with HART, PROFIBUS DP, PROFINET and EtherNet/IP): English, German, French, Spanish, Italian, Dutch, Portuguese, Polish, Russian, Turkish, Chinese, Japanese, Bahasa (Indonesian), Vietnamese, Czech, Swedish, Korean
- Uniform operating philosophy applied to operating tools and Web browser
- If replacing the electronic module, transfer the device configuration via the plug-in memory (HistoROM DAT) which contains the process and measuring device data and the event logbook. No need to reconfigure.  
For devices with Modbus RS485, the data recovery function is implemented without the plug-in memory (HistoROM DAT).

**Efficient diagnostics increase measurement availability**

- Troubleshooting measures can be called up via the operating tools and Web browser
- Diverse simulation options
- Status indicated by several light emitting diodes (LEDs) on the electronic module in the housing compartment

**Local display**

 A local display is only available for device versions with the following communication protocols: HART, PROFIBUS-DP, PROFINET, EtherNet/IP

The local display is only available with the following device order code:  
Order code for "Display; Operation", option **B**: 4-line; lit, via communication

**Display element**

- 4-line liquid crystal display with 16 characters per line.
- White background lighting; switches to red in event of device errors.
- Format for displaying measured variables and status variables can be individually configured.
- Permitted ambient temperature for the display: -20 to +60 °C (-4 to +140 °F). The readability of the display may be impaired at temperatures outside the temperature range.

**Remote operation**

**Via HART protocol**

This communication interface is available in device versions with a HART output.

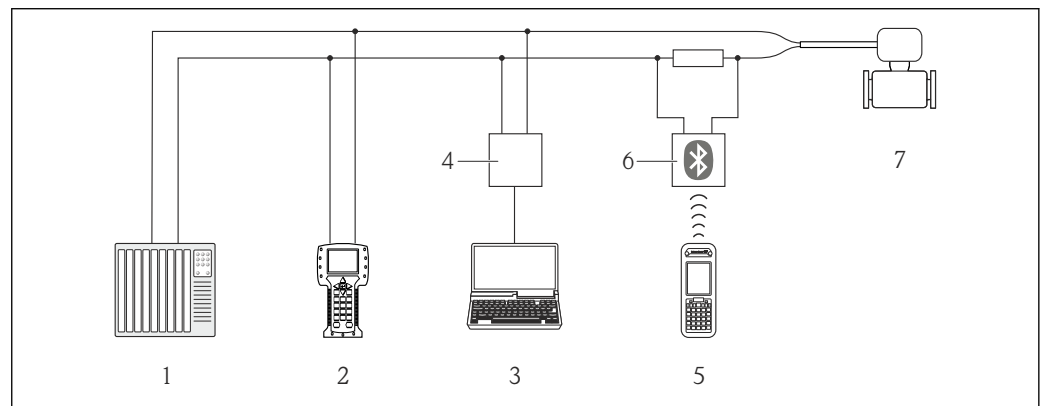

 30 Options for remote operation via HART protocol

- 1 Control system (e.g. PLC)
- 2 Field Communicator 475
- 3 Computer with operating tool (e.g. FieldCare, AMS Device Manager, SIMATIC PDM)
- 4 Commubox FXA195 (USB)
- 5 Field Xpert SFX350 or SFX370
- 6 VIATOR Bluetooth modem with connecting cable
- 7 Transmitter

**Via PROFIBUS DP network**

This communication interface is available in device versions with PROFIBUS DP.

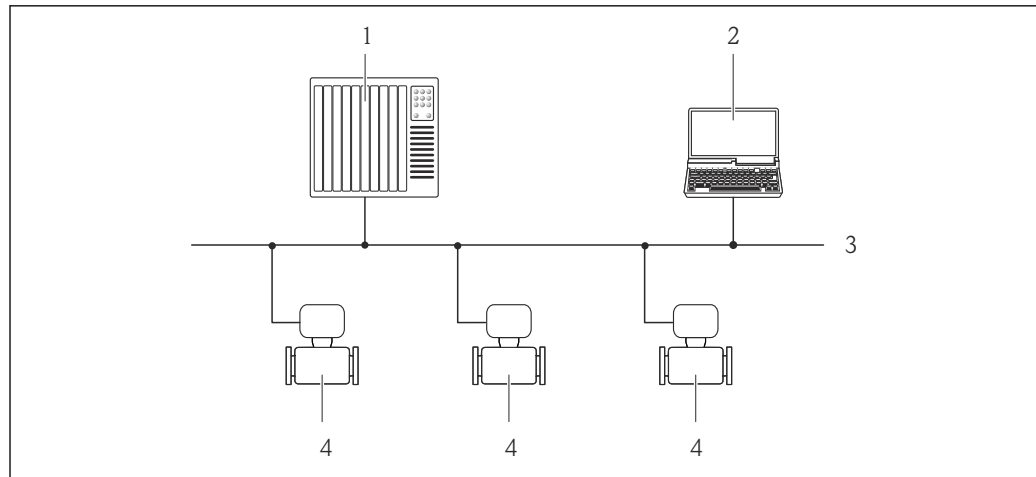

A0020903

31 Options for remote operation via PROFIBUS DP network

- 1 Automation system
- 2 Computer with PROFIBUS network card
- 3 PROFIBUS DP network
- 4 Measuring device

### Via Ethernet-based fieldbus

This communication interface is available in device versions with EtherNet/IP.

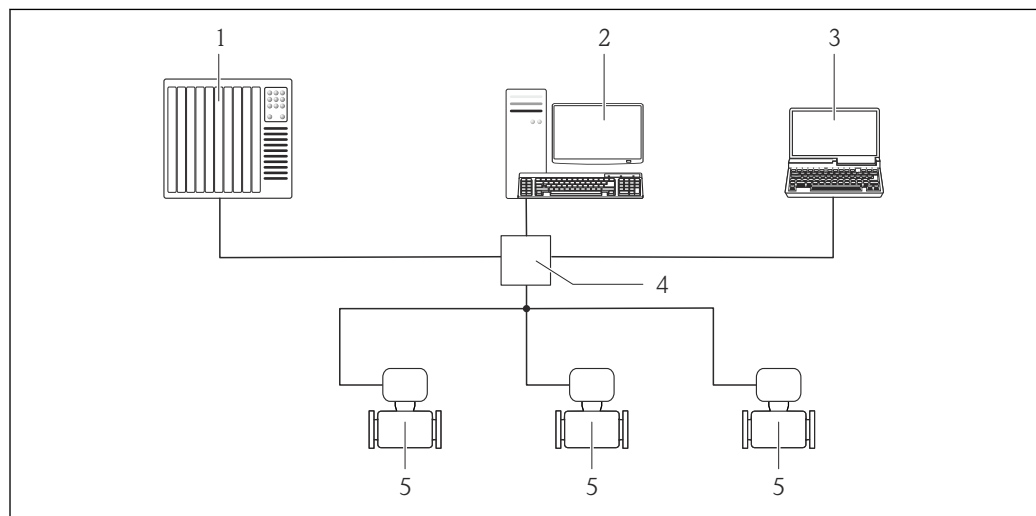

A0016961

32 Options for remote operation via Ethernet-based fieldbus

- 1 Control system, e.g. "RSLogix" (Rockwell Automation)
- 2 Workstation for measuring device operation: with Add-on Profile Level 3 for "RSLogix 5000" (Rockwell Automation) or with Electronic Data Sheet (EDS)
- 3 Computer with Web browser (e.g. Internet Explorer) for accessing the integrated device Web server or with "FieldCare" operating tool with COM DTM "CDI Communication TCP/IP"
- 4 Ethernet switch
- 5 Measuring device

### Via PROFINET network

This communication interface is available in device versions with PROFINET.

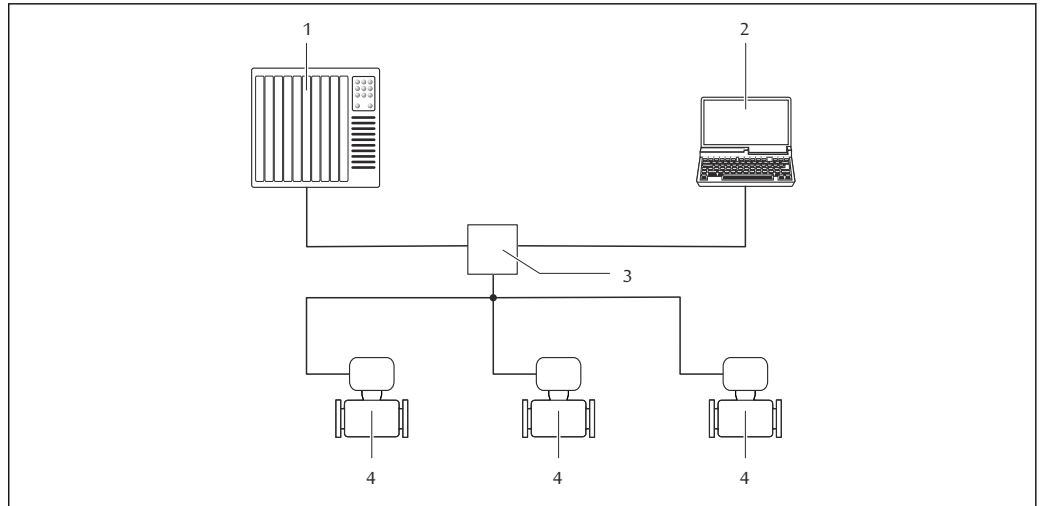

A0026545

33 Options for remote operation via PROFINET network

- 1 Automation system, e.g. Simatic S7 (Siemens)
- 2 Computer with Web browser (e.g. Internet Explorer) for accessing the integrated device Web server or with "FieldCare" operating tool with COM DTM "CDI Communication TCP/IP"
- 3 Switch, e.g. Scalance X204 (Siemens)
- 4 Measuring device

**Service interface**

**Via service interface (CDI-RJ45)**

This communication interface is present in the following device version:

- Order code for "Output", option B: 4-20 mA HART, pulse/frequency/switch output
- Order code for "Output", option L: PROFIBUS DP
- Order code for "Output", option N: EtherNet/IP
- Order code for "Output", option R: PROFINET

*HART*

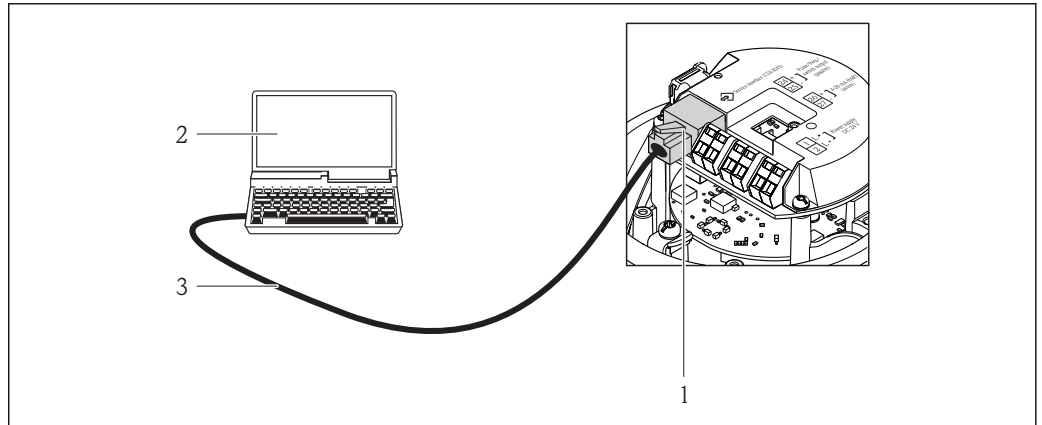

A0016926

34 Connection for the order code for "Output", option B: 4-20 mA HART, pulse/frequency/switch output

- 1 Service interface (CDI -RJ45) of the measuring device with access to the integrated Web server
- 2 Computer with Web browser (e.g. Internet Explorer) for accessing the integrated device Web server or with "FieldCare" operating tool with COM DTM "CDI Communication TCP/IP"
- 3 Standard Ethernet connecting cable with RJ45 plug

## PROFIBUS DP

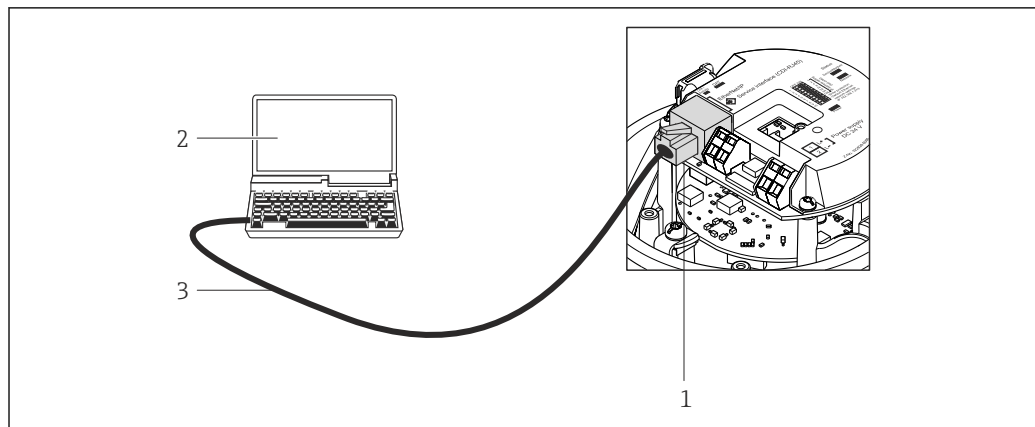

A0021270

35 Connection for order code for "Output", option L: PROFIBUS DP

- 1 Service interface (CDI -RJ45) of the measuring device with access to the integrated Web server
- 2 Computer with Web browser (e.g. Internet Explorer) for accessing the integrated device Web server or with "FieldCare" operating tool with COM DTM "CDI Communication TCP/IP"
- 3 Standard Ethernet connecting cable with RJ45 plug

## EtherNet/IP

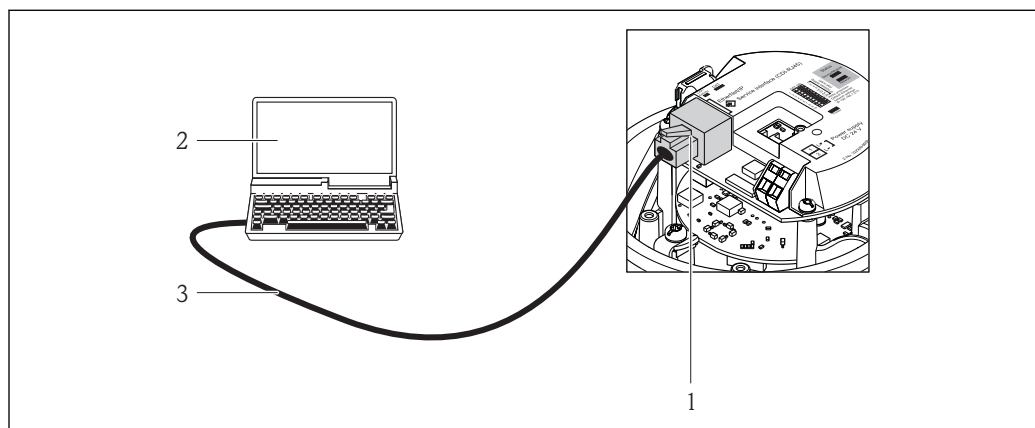

A0016940

36 Connection for order code for "Output", option N: EtherNet/IP

- 1 Service interface (CDI -RJ45) and EtherNet/IP interface of the measuring device with access to the integrated Web server
- 2 Computer with Web browser (e.g. Internet Explorer) for accessing the integrated device Web server or with "FieldCare" operating tool with COM DTM "CDI Communication TCP/IP"
- 3 Standard Ethernet connecting cable with RJ45 plug

PROFINET

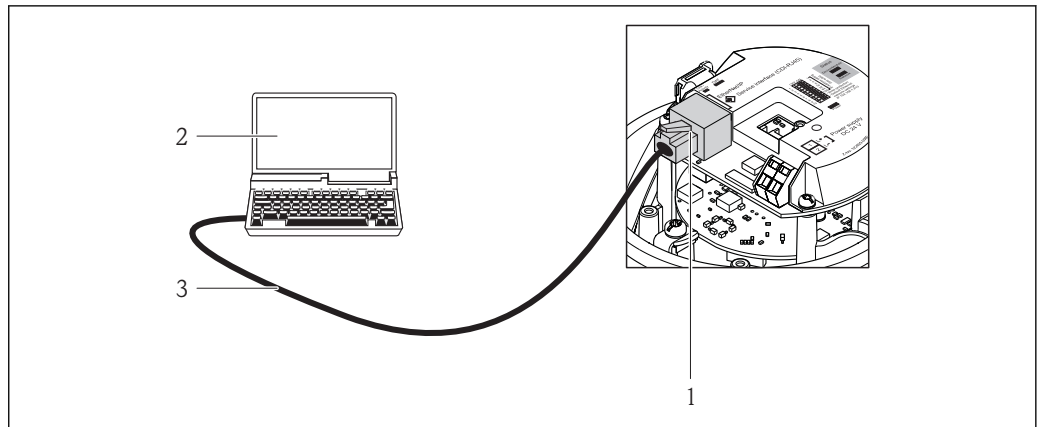

A0016940

37 Connection for order code for "Output", option R: PROFINET

- 1 Service interface (CDI -RJ45) and PROFINET interface of the measuring device with access to the integrated Web server
- 2 Computer with Web browser (e.g. Internet Explorer) for accessing the integrated device Web server or with "FieldCare" operating tool with COM DTM "CDI Communication TCP/IP"
- 3 Standard Ethernet connecting cable with RJ45 plug

**Via service interface (CDI)**

This communication interface is present in the following device version:

Order code for "Output", option **M**: Modbus RS485

*Modbus RS485*

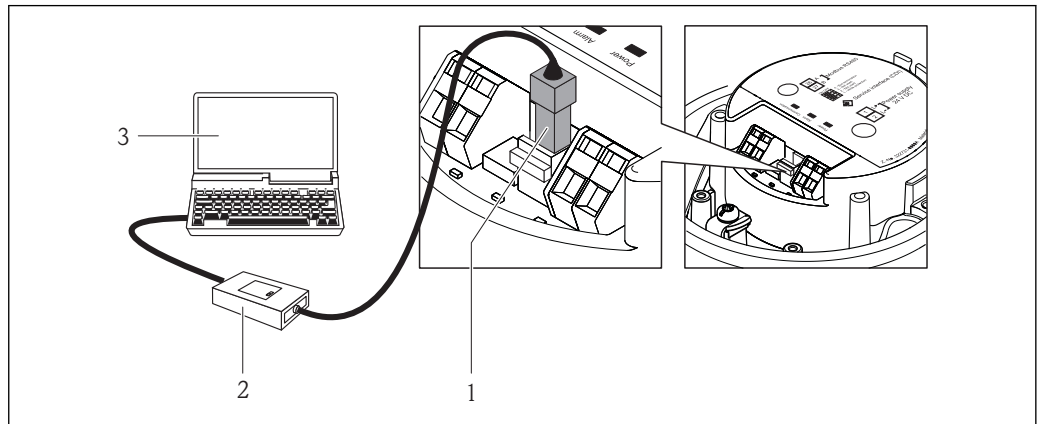

A0016925

- 1 Service interface (CDI) of the measuring device
- 2 Commubox FXA291
- 3 Computer with "FieldCare" operating tool with COM DTM "CDI Communication FXA291"

## Certificates and approvals

**CE mark**

The measuring system is in conformity with the statutory requirements of the applicable EC Directives. These are listed in the corresponding EC Declaration of Conformity along with the standards applied.

Endress+Hauser confirms successful testing of the device by affixing to it the CE mark.

**C-Tick symbol**

The measuring system meets the EMC requirements of the "Australian Communications and Media Authority (ACMA)".

**Ex approval**

The measuring device is certified for use in hazardous areas and the relevant safety instructions are provided in the separate "Safety Instructions" (XA) document. Reference is made to this document on the nameplate.

 The separate Ex documentation (XA) containing all the relevant explosion protection data is available from your Endress+Hauser sales center.

**ATEX/IECEX**

Currently, the following versions for use in hazardous areas are available:

*Ex ia*

Category (ATEX)	Type of protection
II2G	Ex ia IIC T6...T1 Gb
II2G	Ex ia IIC T6...T1 Gb or Ex ia IIB T6...T1 Gb
II1/2G, II2D	Ex ia IIC T6...T1 Ga/Gb or Ex ia IIB T6...T1 Ga/Gb Ex tb IIIC Txx °C Db
II2G, II2D	Ex ia IIC T6...T1 Gb or Ex ia IIB T6...T1 Gb Ex tb IIIC Txx °C Db

*Ex nA*

Category (ATEX)	Type of protection
II3G	Ex nA IIC T6...T1 Gc or Ex nA IIC T5-T1 Gc

**cCSA<sub>US</sub>**

Currently, the following versions for use in hazardous areas are available:

*IS (Ex i)*

- Class I Division 1 Groups ABCD
- Class II Division 1 Groups EFG and Class III

*NI (Ex nA)*

Class I Division 2 Groups ABCD

**HART certification****HART interface**

The measuring device is certified and registered by the FieldComm Group. The measuring system meets all the requirements of the following specifications:

- Certified according to HART 7
- The device can also be operated with certified devices of other manufacturers (interoperability)

**Certification PROFIBUS****PROFIBUS interface**

The measuring device is certified and registered by the PROFIBUS User Organization (PNO). The measuring system meets all the requirements of the following specifications:

- Certified in accordance with PROFIBUS PA Profile 3.02
- The device can also be operated with certified devices of other manufacturers (interoperability)

**Certification PROFINET****PROFINET interface**

The measuring device is certified and registered by the PNO (PROFIBUS User Organization). The measuring system meets all the requirements of the following specifications:

- Certified according to:
  - Test specification for PROFINET devices
  - PROFINET Security Level 1 – Net load test
- The device can also be operated with certified devices of other manufacturers (interoperability)



<b>EtherNet/IP certification</b>	<p>The measuring device is certified and registered by the ODVA (Open Device Vendor Association). The measuring system meets all the requirements of the following specifications:</p> <ul style="list-style-type: none"> <li>■ Certified in accordance with the ODVA Conformance Test</li> <li>■ EtherNet/IP Performance Test</li> <li>■ EtherNet/IP PlugFest compliance</li> <li>■ The device can also be operated with certified devices of other manufacturers (interoperability)</li> </ul>
<b>Modbus RS485 certification</b>	<p>The measuring device meets all the requirements of the MODBUS/TCP conformity test and has the "MODBUS/TCP Conformance Test Policy, Version 2.0". The measuring device has successfully passed all the test procedures carried out and is certified by the "MODBUS/TCP Conformance Test Laboratory" of the University of Michigan.</p>
<b>Pressure Equipment Directive</b>	<p>The devices can be ordered with or without a PED approval. If a device with a PED approval is required, this must be explicitly stated in the order. For devices with nominal diameters less than or equal to DN 25 (1"), this is neither possible nor necessary.</p> <ul style="list-style-type: none"> <li>■ With the PED/G1/x (x = category) marking on the sensor nameplate, Endress+Hauser confirms compliance with the "Essential Safety Requirements" specified in Annex I of the Pressure Equipment Directive 97/23/EC.</li> <li>■ Devices bearing this marking (PED) are suitable for the following types of medium: <ul style="list-style-type: none"> <li>- Media in Group 1 and 2 with a vapor pressure greater than, or smaller and equal to 0.5 bar (7.3 psi)</li> <li>- Unstable gases</li> </ul> </li> <li>■ Devices not bearing this marking (PED) are designed and manufactured according to good engineering practice. They meet the requirements of Art. 3 Section 3 of the Pressure Equipment Directive 97/23/EC. The range of application is indicated in tables 6 to 9 in Annex II of the Pressure Equipment Directive.</li> </ul>
<b>Other standards and guidelines</b>	<ul style="list-style-type: none"> <li>■ EN 60529 Degrees of protection provided by enclosures (IP code)</li> <li>■ IEC/EN 60068-2-6 Environmental influences: Test procedure - Test Fc: vibrate (sinusoidal).</li> <li>■ IEC/EN 60068-2-31 Environmental influences: Test procedure - Test Ec: shocks due to rough handling, primarily for devices.</li> <li>■ EN 61010-1 Safety requirements for electrical equipment for measurement, control and laboratory use - general requirements</li> <li>■ IEC/EN 61326 Emission in accordance with Class A requirements. Electromagnetic compatibility (EMC requirements).</li> <li>■ NAMUR NE 21 Electromagnetic compatibility (EMC) of industrial process and laboratory control equipment</li> <li>■ NAMUR NE 32 Data retention in the event of a power failure in field and control instruments with microprocessors</li> <li>■ NAMUR NE 43 Standardization of the signal level for the breakdown information of digital transmitters with analog output signal.</li> <li>■ NAMUR NE 53 Software of field devices and signal-processing devices with digital electronics</li> <li>■ NAMUR NE 80 The application of the pressure equipment directive to process control devices</li> <li>■ NAMUR NE 105 Specifications for integrating fieldbus devices in engineering tools for field devices</li> <li>■ NAMUR NE 107 Self-monitoring and diagnosis of field devices</li> <li>■ NAMUR NE 131 Requirements for field devices for standard applications</li> <li>■ NAMUR NE 132 Coriolis mass meter</li> </ul>

## Ordering information

Detailed ordering information is available from the following sources:

- In the Product Configurator on the Endress+Hauser website: [www.endress.com](http://www.endress.com) → Select your country → Products → Select measuring technology, software or components → Select the product (picklists: measurement method, product family etc.) → Device support (right-hand column): Configure the selected product → The Product Configurator for the selected product opens.
- From your Endress+Hauser Sales Center: [www.addresses.endress.com](http://www.addresses.endress.com)



### Product Configurator - the tool for individual product configuration

- Up-to-the-minute configuration data
- Depending on the device: Direct input of measuring point-specific information such as measuring range or operating language
- Automatic verification of exclusion criteria
- Automatic creation of the order code and its breakdown in PDF or Excel output format
- Ability to order directly in the Endress+Hauser Online Shop

## Application packages

Many different application packages are available to enhance the functionality of the device. Such packages might be needed to address safety aspects or specific application requirements.

The application packages can be ordered with the device or subsequently from Endress+Hauser. Detailed information on the order code in question is available from your local Endress+Hauser sales center or on the product page of the Endress+Hauser website: [www.endress.com](http://www.endress.com).



Detailed information on the application packages:

- Special Documentation for the device
- Special Documentation for the device

### Heartbeat Technology

Package	Description
Heartbeat Verification +Monitoring	<p><b>Heartbeat Monitoring</b> Continuously supplies data, which are characteristic of the measuring principle, to an external condition monitoring system for the purpose of preventive maintenance or process analysis. These data enable the operator to:</p> <ul style="list-style-type: none"> <li>▪ Draw conclusions - using these data and other information - about the impact process influences (such as corrosion, abrasion, buildup etc.) have on the measuring performance over time.</li> <li>▪ Schedule servicing in time.</li> <li>▪ Monitor the process or product quality, e.g. gas pockets.</li> </ul> <p><b>Heartbeat Verification</b> Meets the requirement for traceable verification to DIN ISO 9001:2008 Chapter 7.6 a) "Control of monitoring and measuring equipment".</p> <ul style="list-style-type: none"> <li>▪ Functional testing in the installed state without interrupting the process.</li> <li>▪ Traceable verification results on request, including a report.</li> <li>▪ Simple testing process via local operation or other operating interfaces.</li> <li>▪ Clear measuring point assessment (pass/fail) with high test coverage within the framework of manufacturer specifications.</li> <li>▪ Extension of calibration intervals according to operator's risk assessment.</li> </ul>

**Concentration**

Package	Description
Concentration measurement and special density	<p><b>Calculation and outputting of fluid concentrations</b></p> <p>Many applications use density as a key measured value for monitoring quality or controlling processes. The device measures the density of the fluid as standard and makes this value available to the control system.</p> <p>The "Special Density" application package offers high-precision density measurement over a wide density and temperature range particularly for applications subject to varying process conditions.</p> <p>With the help of the "Concentration Measurement" application package, the measured density is used to calculate other process parameters:</p> <ul style="list-style-type: none"> <li>▪ Temperature-compensated density (reference density).</li> <li>▪ Percentage mass of the individual substances in a two-phase fluid. (Concentration in %).</li> <li>▪ Fluid concentration is output with special units (°Brix, °Baumé, °API, etc.) for standard applications.</li> </ul> <p>The measured values are output via the digital and analog outputs of the device.</p>

## Accessories





Various accessories, which can be ordered with the device or subsequently from Endress+Hauser, are available for the device. Detailed information on the order code in question is available from your local Endress+Hauser sales center or on the product page of the Endress+Hauser website: [www.endress.com](http://www.endress.com).



**Device-specific accessories**

**For the sensor**



Accessories	Description
Heating jacket	<p>Is used to stabilize the temperature of the fluids in the sensor. Water, water vapor and other non-corrosive liquids are permitted for use as fluids. If using oil as a heating medium, please consult with Endress+Hauser.</p> <p> For details, see Operating Instructions BA00099D</p>

**Communication-specific accessories**



Accessories	Description
Commubox FXA195 HART	<p>For intrinsically safe HART communication with FieldCare via the USB interface.</p> <p> For details, see "Technical Information" TI00404F</p>
Commubox FXA291	<p>Connects Endress+Hauser field devices with a CDI interface (= Endress+Hauser Common Data Interface) and the USB port of a computer or laptop.</p> <p> For details, see the "Technical Information" document TI405C/07</p>
HART Loop Converter HMX50	<p>Is used to evaluate and convert dynamic HART process variables to analog current signals or limit values.</p> <p> For details, see "Technical Information" TI00429F and Operating Instructions BA00371F</p>
Wireless HART adapter SWA70	<p>Is used for the wireless connection of field devices. The WirelessHART adapter can be easily integrated into field devices and existing infrastructures, offers data protection and transmission safety and can be operated in parallel with other wireless networks with minimum cabling complexity.</p> <p> For details, see Operating Instructions BA00061S</p>
Fieldgate FXA320	<p>Gateway for the remote monitoring of connected 4-20 mA measuring devices via a Web browser.</p> <p> For details, see "Technical Information" TI00025S and Operating Instructions BA00053S</p>

Fieldgate FXA520	Gateway for the remote diagnostics and remote configuration of connected HART measuring devices via a Web browser.  For details, see "Technical Information" TI00025S and Operating Instructions BA00051S
Field Xpert SFX350	Field Xpert SFX350 is a mobile computer for commissioning and maintenance. It enables efficient device configuration and diagnostics for HART and FOUNDATION Fieldbus devices in the <b>non-Ex area</b> .  For details, see Operating Instructions BA01202S
Field Xpert SFX370	Field Xpert SFX370 is a mobile computer for commissioning and maintenance. It enables efficient device configuration and diagnostics for HART and FOUNDATION Fieldbus devices in the <b>non-Ex area</b> and the <b>Ex area</b> .  For details, see Operating Instructions BA01202S

## Service-specific accessories

Accessories	Description
Applicator	Software for selecting and sizing Endress+Hauser measuring devices: <ul style="list-style-type: none"> <li>Calculation of all the necessary data for identifying the optimum flowmeter: e.g. nominal diameter, pressure loss, accuracy or process connections.</li> <li>Graphic illustration of the calculation results</li> </ul> Administration, documentation and access to all project-related data and parameters throughout the entire life cycle of a project. Applicator is available: <ul style="list-style-type: none"> <li>Via the Internet: <a href="https://wapps.endress.com/applicator">https://wapps.endress.com/applicator</a></li> <li>On CD-ROM for local PC installation.</li> </ul>
W@M	Life cycle management for your plant W@M supports you with a wide range of software applications over the entire process: from planning and procurement, to the installation, commissioning and operation of the measuring devices. All the relevant device information, such as the device status, spare parts and device-specific documentation, is available for every device over the entire life cycle. The application already contains the data of your Endress+Hauser device. Endress+Hauser also takes care of maintaining and updating the data records. W@M is available: <ul style="list-style-type: none"> <li>Via the Internet: <a href="http://www.endress.com/lifecyclemanagement">www.endress.com/lifecyclemanagement</a></li> <li>On CD-ROM for local PC installation.</li> </ul>
FieldCare	FDT-based plant asset management tool from Endress+Hauser. It can configure all smart field units in your system and helps you manage them. By using the status information, it is also a simple but effective way of checking their status and condition.  For details, see Operating Instructions BA00027S and BA00059S
DeviceCare	Tool for connecting and configuring Endress+Hauser field devices.  For details, see Innovation brochure IN01047S
Commubox FXA291	Connects Endress+Hauser field devices with a CDI interface (= Endress+Hauser Common Data Interface) and the USB port of a computer or laptop.  For details, see "Technical Information" TI00405C

**System components**

Accessories	Description
Memograph M graphic display recorder	The Memograph M graphic display recorder provides information on all relevant measured variables. Measured values are recorded correctly, limit values are monitored and measuring points analyzed. The data are stored in the 256 MB internal memory and also on a SD card or USB stick.  For details, see "Technical Information" TI00133R and Operating Instructions BA00247R
iTEMP	The temperature transmitters can be used in all applications and are suitable for the measurement of gases, steam and liquids. They can be used to read in the fluid temperature.  For details, see "Fields of Activity", FA00006T

## Supplementary documentation



For an overview of the scope of the associated Technical Documentation, refer to the following:

- The *W@M Device Viewer* : Enter the serial number from the nameplate ([www.endress.com/deviceviewer](http://www.endress.com/deviceviewer))
- The *Endress+Hauser Operations App*: Enter the serial number from the nameplate or scan the 2-D matrix code (QR code) on the nameplate.

**Standard documentation**

**Brief Operating Instructions**



Brief Operating Instructions containing the most important information for standard commissioning are supplied with the device.

**Operating Instructions**

Measuring device	Documentation code				
	HART	PROFIBUS DP	Modbus RS485	EtherNet/IP	PROFINET
Promass H 100	BA01189D	BA01250D	BA01177D	BA01184D	BA01428D

**Description of device parameters**

Measuring device	Documentation code				
	HART	PROFIBUS DP	Modbus RS485	EtherNet/IP	PROFINET
Promass 100	GP01033D	GP01034D	GP01035D	GP01036D	GP01037D

**Supplementary device-dependent documentation**

**Safety Instructions**

Content	Documentation code
ATEX/IECEX Ex i	XA00159D
ATEX/IECEX Ex nA	XA01029D
cCSAus IS	XA00160D
INMETRO Ex i	XA01219D
INMETRO Ex nA	XA01220D
NEPSI Ex i	XA01249D
NEPSI Ex nA	XA01262D

**Special Documentation**

Content	Documentation code
Information on the Pressure Equipment Directive	SD00142D
Modbus RS485 Register Information	SD00154D
Concentration Measurement	SD01152D
Heartbeat Technology	SD01153D

**Installation Instructions**

Contents	Documentation code
Installation Instructions for spare part sets	Specified for each individual accessory

**Registered trademarks****HART®**

Registered trademark of the HART Communication Foundation, Austin, USA

**PROFIBUS®**

Registered trademark of the PROFIBUS User Organization, Karlsruhe, Germany

**Modbus®**

Registered trademark of SCHNEIDER AUTOMATION, INC.

**EtherNet/IP™**

Trademark of ODVA, Inc.

**PROFINET®**

Registered trademark of the PROFIBUS User Organization, Karlsruhe, Germany

**Microsoft®**

Registered trademark of the Microsoft Corporation, Redmond, Washington, USA

**TRI-CLAMP®**

Registered trademark of Ladish & Co., Inc., Kenosha, USA

**Applicator®, FieldCare®, DeviceCare®, Field Xpert™, HistoROM®, TMB®, Heartbeat Technology™**

Registered or registration-pending trademarks of the Endress+Hauser Group

---

[www.addresses.endress.com](http://www.addresses.endress.com)

---