

Technical Information

Proline Promag P 300

Electromagnetic flowmeter



The flowmeter for highest medium temperatures with a compact, easily accessible transmitter

Application

- The bidirectional measuring principle is virtually independent of pressure, density, temperature and viscosity
- Dedicated to chemical and process applications with corrosive liquids and high medium temperatures

Device properties

- Nominal diameter: max. DN 600 (24")
- All common Ex approvals
- Liner made of PTFE or PFA
- Compact dual-compartment housing with up to 3 I/Os
- Backlit display with touch control and WLAN access
- Remote display available

Your benefits

- Versatile applications – wide variety of wetted materials
- Energy-saving flow measurement – no pressure loss due to cross-section constriction
- Maintenance-free – no moving parts
- Full access to process and diagnostic information – numerous, freely combinable I/Os and fieldbuses
- Reduced complexity and variety – freely configurable I/O functionality
- Integrated verification – Heartbeat Technology

Table of contents





About this document	4	Mechanical load	48
Symbols used	4	Electromagnetic compatibility (EMC)	48
Function and system design	5	Process	49
Measuring principle	5	Medium temperature range	49
Measuring system	6	Conductivity	50
Equipment architecture	7	Pressure-temperature ratings	50
Safety	7	Pressure tightness	52
Input	9	Flow limit	53
Measured variable	9	Pressure loss	53
Measuring range	9	System pressure	54
Operable flow range	10	Thermal insulation	54
Input signal	11	Vibrations	55
Output	12	Mechanical construction	55
Output and input variants	12	Dimensions in SI units	55
Output signal	13	Dimensions in US units	64
Signal on alarm	16	Weight	69
Ex connection data	19	Measuring tube specification	70
Low flow cut off	20	Materials	71
Galvanic isolation	20	Fitted electrodes	72
Protocol-specific data	20	Process connections	73
Power supply	25	Surface roughness	73
Terminal assignment	25	Operability	73
Device plugs available	26	Operating concept	73
Pin assignment, device plug	27	Languages	73
Supply voltage	28	Local operation	73
Power consumption	29	Remote operation	75
Current consumption	29	Service interface	80
Power supply failure	29	Network integration	81
Electrical connection	30	Supported operating tools	82
Potential equalization	39	HistoROM data management	83
terminals	41	Certificates and approvals	85
Cable entries	41	CE mark	85
Cable specification	41	C-Tick symbol	85
Performance characteristics	43	Ex approval	85
Reference operating conditions	43	Pharmaceutical compatibility	86
Maximum measured error	43	Functional safety	86
Repeatability	44	HART certification	86
Influence of ambient temperature	44	FOUNDATION Fieldbus certification	86
Installation	45	Certification PROFIBUS	86
Mounting location	45	EtherNet/IP certification	86
Orientation	46	Certification PROFINET	86
Inlet and outlet runs	47	Radio approval	86
Adapters	47	Pressure Equipment Directive	86
Environment	48	Measuring instrument approval	87
Ambient temperature range	48	Additional certification	87
Storage temperature	48	Other standards and guidelines	87
Degree of protection	48	Ordering information	88
Vibration resistance	48	Application packages	88
Shock resistance	48	Diagnostics functions	88
Shock resistance	48	Heartbeat Technology	88
		Cleaning	89

OPC-UA server	89
Accessories	89
Device-specific accessories	89
Communication-specific accessories	90
Service-specific accessories	91
System components	91
Supplementary documentation	92
Standard documentation	92
Device-dependent additional documentation	92
Registered trademarks	93





About this document

Symbols used









Electrical symbols

Symbol	Meaning
	Direct current
	Alternating current
	Direct current and alternating current
	Ground connection A grounded terminal which, as far as the operator is concerned, is grounded via a grounding system.
	Protective Earth (PE) A terminal which must be connected to ground prior to establishing any other connections. The ground terminals are situated inside and outside the device: <ul style="list-style-type: none"> ▪ Inner ground terminal: Connects the protective earth to the mains supply. ▪ Outer ground terminal: Connects the device to the plant grounding system.



Communication symbols

Symbol	Meaning
	Wireless Local Area Network (WLAN) Communication via a wireless, local network.
	LED Light emitting diode is off.
	LED Light emitting diode is on.
	LED Light emitting diode is flashing.

Symbols for certain types of information

Symbol	Meaning
	Permitted Procedures, processes or actions that are permitted.
	Preferred Procedures, processes or actions that are preferred.
	Forbidden Procedures, processes or actions that are forbidden.
	Tip Indicates additional information.
	Reference to documentation.
	Reference to page.
	Reference to graphic.
	Visual inspection.

Symbols in graphics

Symbol	Meaning
1, 2, 3, ...	Item numbers
1, 2, 3, ...	Series of steps
A, B, C, ...	Views
A-A, B-B, C-C, ...	Sections
	Hazardous area
	Safe area (non-hazardous area)
	Flow direction

Function and system design

Measuring principle

Following *Faraday's law of magnetic induction*, a voltage is induced in a conductor moving through a magnetic field.

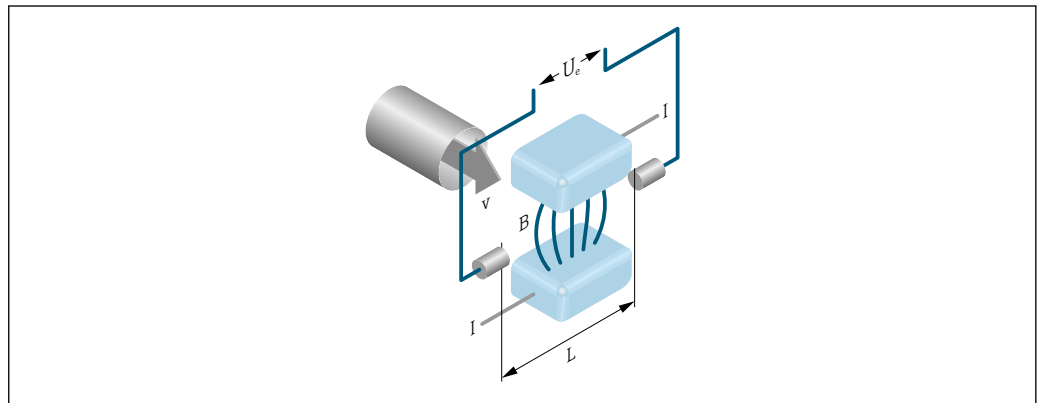

A0028962

- U_e Induced voltage
- B Magnetic induction (magnetic field)
- L Electrode spacing
- I Current
- v Flow velocity

In the electromagnetic measuring principle, the flowing medium is the moving conductor. The voltage induced (U_e) is proportional to the flow velocity (v) and is supplied to the amplifier by means of two measuring electrodes. The flow volume (Q) is calculated via the pipe cross-section (A). The DC magnetic field is created through a switched direct current of alternating polarity.

Formulae for calculation

- Induced voltage $U_e = B \cdot L \cdot v$
- Volume flow $Q = A \cdot v$

Measuring system

The device consists of a transmitter and a sensor.

The device is available as a compact version:

The transmitter and sensor form a mechanical unit.

Transmitter

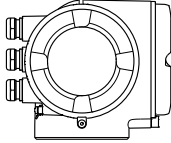
<p>Promag 300</p>  <p>A0026708</p>	<p>Device versions and materials:</p> <ul style="list-style-type: none"> ■ Transmitter housing <ul style="list-style-type: none"> Aluminum, coated: aluminum, AlSi10Mg, coated ■ Material of window in transmitter housing: <ul style="list-style-type: none"> Aluminum, coated: glass <p>Configuration:</p> <ul style="list-style-type: none"> ■ External operation via 4-line, backlit, graphic local display with touch control and guided menus ("Make-it-run" wizards) for application-specific commissioning. ■ Via service interface or WLAN interface: <ul style="list-style-type: none"> - Operating tools (e.g. FieldCare, DeviceCare, SmartBlue app) - Web server (access via Web browser, e.g. Microsoft Internet Explorer, Microsoft Edge)
--	--

Sensor

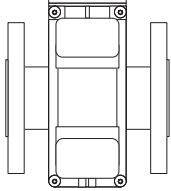
<p>Promag P</p>  <p>A0017703</p>	<p>Nominal diameter range: DN 15 to 600 (½ to 24")</p> <p>Materials:</p> <ul style="list-style-type: none"> ■ Sensor housing: <ul style="list-style-type: none"> - Aluminum, AlSi10Mg, coated - DN 15 to 300 (½ to 12"): aluminum, AlSi10Mg, coated - DN 350 to 600 (14 to 24"): carbon steel with protective varnish ■ Measuring tubes ¹⁾: stainless steel, 1.4301/1.4306 ■ Liner: PFA, PTFE ■ Electrodes: stainless steel, 1.4435 (F316L); Alloy C22, 2.4602 (UNS N06022); platinum; tantalum; titanium ■ Process connections: stainless steel, 1.4571/F316L; carbon steel, A105/FE410WB/HII/S235JRG2/S275JR ■ Seals: as per DIN EN 1514-1 ■ Ground disks: stainless steel, 1.4435 (316L); Alloy C22, 2.4602 (UNS N06022); tantalum; titanium
---	---

1) For flanges made of carbon steel with Al/Zn protective coating (DN 15 to 300 (½ to 12")) or protective varnish (DN 350 to 600 (14 to 24"))

Equipment architecture

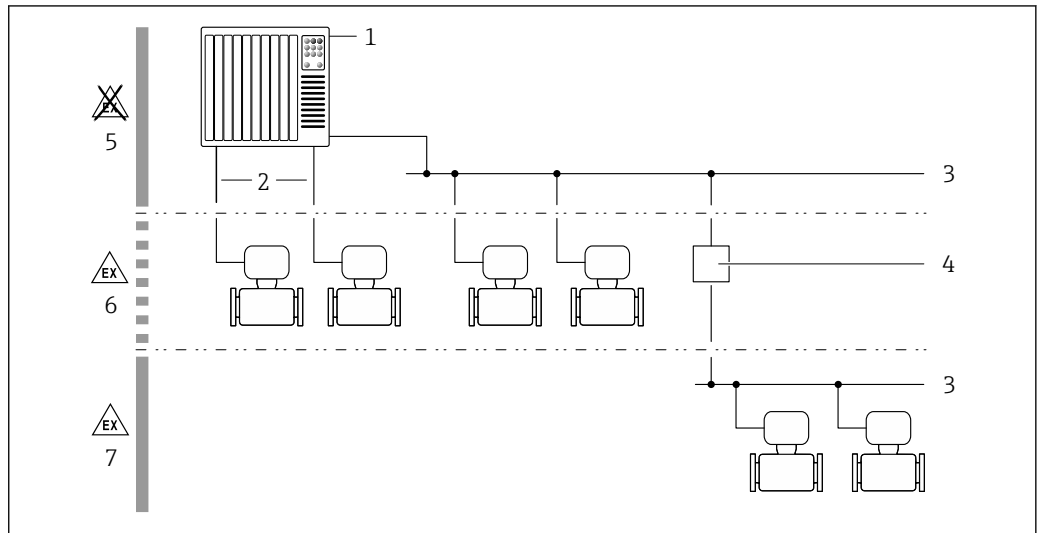

A0027512

1 Possibilities for integrating measuring devices into a system

- 1 Control system (e.g. PLC)
- 2 Connecting cable (0/4 to 20 mA HART etc.)
- 3 Fieldbus
- 4 Segment coupler
- 5 Non-hazardous area
- 6 Hazardous area: Zone 2; Class I, Division 2
- 7 Hazardous area: Zone 1; Class I, Division 1

Safety

IT security

Our warranty is valid only if the device is installed and used as described in the Operating Instructions. The device is equipped with security mechanisms to protect it against any inadvertent changes to the settings.

IT security measures, which provide additional protection for the device and associated data transfer, must be implemented by the operators themselves in line with their security standards.

Device-specific IT security

The device offers a range of specific functions to support protective measures on the operator's side. These functions can be configured by the user and guarantee greater in-operation safety if used correctly. An overview of the most important functions is provided in the following section.

Function/interface	Factory setting	Recommendation
Write protection via hardware write protection switch → 8	Not enabled.	On an individual basis following risk assessment.
Access code (also applies for Web server login or FieldCare connection) → 8	Not enabled (0000).	Assign a customized access code during commissioning.
WLAN (order option in display module)	Enabled.	On an individual basis following risk assessment.
WLAN security mode	Enabled (WPA2-PSK)	Do not change.
WLAN passphrase (password) → 8	Serial number	Assign a customized access code during commissioning.
WLAN mode	Access Point	On an individual basis following risk assessment.
Web server → 8	Enabled.	On an individual basis following risk assessment.
CDI-RJ45 service interface → 9	-	On an individual basis following risk assessment.

Protecting access via hardware write protection

Write access to the device parameters via the local display, Web browser or operating tool (e.g. FieldCare, DeviceCare) can be disabled via a write protection switch (DIP switch on the motherboard). When hardware write protection is enabled, only read access to the parameters is possible.

Hardware write protection is disabled when the device is delivered.

Protecting access via a password

Different passwords are available to protect write access to the device parameters or access to the device via the WLAN interface.

- **User-specific access code**
Protect write access to the device parameters via the local display, Web browser or operating tool (e.g. FieldCare, DeviceCare). Access authorization is clearly regulated through the use of a user-specific access code.
- **WLAN passphrase**
The network key protects a connection between an operating unit (e.g. notebook or tablet) and the device via the WLAN interface which can be ordered as an option.
- **Infrastructure mode**
When the device is operated in infrastructure mode, the WLAN passphrase corresponds to the WLAN passphrase configured on the operator side.

User-specific access code

Write access to the device parameters via the local display, Web browser or operating tool (e.g. FieldCare, DeviceCare) can be protected by the modifiable, user-specific access code.

WLAN passphrase: Operation as WLAN access point

A connection between an operating unit (e.g. notebook or tablet) and the device via the WLAN interface, which can be ordered as an optional extra, is protected by the network key. The WLAN authentication of the network key complies with the IEEE 802.11 standard.

When the device is delivered, the network key is pre-defined depending on the device. It can be changed via the **WLAN settings** submenu in the **WLAN passphrase** parameter.

Infrastructure mode

A connection between the device and WLAN access point is protected by means of an SSID and passphrase on the system side. Please contact the relevant system administrator for access.

General notes on the use of passwords

- The access code and network key supplied with the device should be changed during commissioning.
- Follow the general rules for generating a secure password when defining and managing the access code or network key.
- The user is responsible for the management and careful handling of the access code and network key.

Access via Web server

The device can be operated and configured via a Web browser with the integrated Web server. The connection is via the service interface (CDI-RJ45) or the WLAN interface. For device versions with the EtherNet/IP and PROFINET communication protocols, the connection can also be established via the terminal connection for signal transmission with EtherNet/IP or PROFINET (RJ45 connector).

The Web server is enabled when the device is delivered. The Web server can be disabled if necessary (e.g. after commissioning) via the **Web server functionality** parameter.

The device and status information can be hidden on the login page. This prevents unauthorized access to the information.



For detailed information on device parameters, see:
The "Description of Device Parameters" document → 92

Access via OPC-UA

The "OPC UA Server" application package is available in the device version with the HART communication protocol → 89.

The device can communicate with OPC UA clients using the "OPC UA Server" application package.

The OPC UA server integrated in the device can be accessed via the WLAN access point using the WLAN interface - which can be ordered as an optional extra - or the service interface (CDI- RJ45) via Ethernet network. Access rights and authorization as per separate configuration.



The following Security Modes are supported as per the OPC UA Specification (IEC 62541):

- None
- Basic128Rsa15 – signed
- Basic128Rsa15 – signed and encrypted

Access via service interface (CDI-RJ45)

The device can be connected to a network via the service interface (CDI-RJ45). Device-specific functions guarantee the secure operation of the device in a network.

The use of relevant industrial standards and guidelines that have been defined by national and international safety committees, such as IEC/ISA62443 or the IEEE, is recommended. This includes organizational security measures such as the assignment of access authorization as well as technical measures such as network segmentation.

 The device can be integrated in a ring topology. The device is integrated via the terminal connection for signal transmission (output 1) and the connection to the service interface (CDI-RJ45) →  78.

Input

Measured variable

Direct measured variables

- Volume flow (proportional to induced voltage)
- Electrical conductivity

Calculated measured variables

- Mass flow
- Corrected volume flow

Measuring range

Typically $v = 0.01$ to 10 m/s (0.03 to 33 ft/s) with the specified accuracy

Flow characteristic values in SI units: DN 15 to 125 (½ to 4")

Nominal diameter		Recommended flow min./max. full scale value ($v \sim 0.3/10$ m/s) [dm ³ /min]	Factory settings		
[mm]	[in]		Full scale value current output ($v \sim 2.5$ m/s) [dm ³ /min]	Pulse value (~ 2 pulse/s) [dm ³]	Low flow cut off ($v \sim 0.04$ m/s) [dm ³ /min]
15	½	4 to 100	25	0.2	0.5
25	1	9 to 300	75	0.5	1
32	–	15 to 500	125	1	2
40	1 ½	25 to 700	200	1.5	3
50	2	35 to 1100	300	2.5	5
65	–	60 to 2000	500	5	8
80	3	90 to 3000	750	5	12
100	4	145 to 4700	1200	10	20
125	–	220 to 7500	1850	15	30

Flow characteristic values in SI units: DN 150 to 600 (6 to 24")

Nominal diameter		Recommended flow min./max. full scale value (v ~ 0.3/10 m/s)	Factory settings		
[mm]	[in]		Full scale value current output (v ~ 2.5 m/s)	Pulse value (~ 2 pulse/s)	Low flow cut off (v ~ 0.04 m/s)
		[m ³ /h]	[m ³ /h]	[m ³]	[m ³ /h]
150	6	20 to 600	150	0.03	2.5
200	8	35 to 1 100	300	0.05	5
250	10	55 to 1 700	500	0.05	7.5
300	12	80 to 2 400	750	0.1	10
350	14	110 to 3 300	1 000	0.1	15
400	16	140 to 4 200	1 200	0.15	20
450	18	180 to 5 400	1 500	0.25	25
500	20	220 to 6 600	2 000	0.25	30
600	24	310 to 9 600	2 500	0.3	40

Flow characteristic values in US units

Nominal diameter		Recommended flow min./max. full scale value (v ~ 0.3/10 m/s)	Factory settings		
[in]	[mm]		Full scale value current output (v ~ 2.5 m/s)	Pulse value (~ 2 pulse/s)	Low flow cut off (v ~ 0.04 m/s)
		[gal/min]	[gal/min]	[gal]	[gal/min]
½	15	1.0 to 27	6	0.1	0.15
1	25	2.5 to 80	18	0.2	0.25
1 ½	40	7 to 190	50	0.5	0.75
2	50	10 to 300	75	0.5	1.25
3	80	24 to 800	200	2	2.5
4	100	40 to 1 250	300	2	4
6	150	90 to 2 650	600	5	12
8	200	155 to 4 850	1 200	10	15
10	250	250 to 7 500	1 500	15	30
12	300	350 to 10 600	2 400	25	45
14	350	500 to 15 000	3 600	30	60
16	400	600 to 19 000	4 800	50	60
18	450	800 to 24 000	6 000	50	90
20	500	1 000 to 30 000	7 500	75	120
24	600	1 400 to 44 000	10 500	100	180



To calculate the measuring range, use the *Applicator* sizing tool → 91

Recommended measuring range

"Flow limit" section → 53

Operable flow range

Over 1000 : 1

Input signal

Input and output versions

→  12

External measured values

To increase the accuracy of certain measured variables or to calculate the corrected volume flow, the automation system can continuously write different measured values to the measuring device:

- Medium temperature to increase the accuracy of the electrical conductivity (e.g. iTEMP)
- Reference density for calculating the corrected volume flow

 Various pressure transmitters and temperature measuring devices can be ordered from Endress +Hauser: see "Accessories" section →  91

It is recommended to read in external measured values to calculate the corrected volume flow.

HART protocol

The measured values are written from the automation system to the measuring device via the HART protocol. The pressure transmitter must support the following protocol-specific functions:

- HART protocol
- Burst mode

Current input

The measured values are written from the automation system to the measuring device via the current input →  11.

Digital communication

The measured values can be written from the automation system to the measuring via:

- FOUNDATION Fieldbus
- PROFIBUS DP
- PROFIBUS PA
- Modbus RS485
- EtherNet/IP
- PROFINET

Current input 0/4 to 20 mA

Current input	0/4 to 20 mA (active/passive)
Current span	<ul style="list-style-type: none"> ■ 4 to 20 mA (active) ■ 0/4 to 20 mA (passive)
Resolution	1 µA
Voltage drop	Typically: 0.6 to 2 V for 3.6 to 22 mA (passive)
Maximum input voltage	≤ 30 V (passive)
Open-circuit voltage	≤ 28.8 V (active)
Possible input variables	<ul style="list-style-type: none"> ■ Pressure ■ Temperature ■ Density

Status input

Maximum input values	<ul style="list-style-type: none"> ■ DC -3 to 30 V ■ If status input is active (ON): $R_i > 3 \text{ k}\Omega$
Response time	Adjustable: 5 to 200 ms
Input signal level	<ul style="list-style-type: none"> ■ Low signal: DC -3 to +5 V ■ High signal: DC 12 to 30 V
Assignable functions	<ul style="list-style-type: none"> ■ Off ■ Reset the individual totalizers separately ■ Reset all totalizers ■ Flow override

Output

Output and input variants

Depending on the option selected for output/input 1, different options are available for the other outputs and inputs. Only one option can be selected for each output/input 1 to 3. The table must be read vertically (↓).

Example: If the option BA "4–20 mA HART" was selected for output/input 1, one of the options A, B, D, E, F, H, I or J is available for output 2 and one of the options A, B, D, E, F, H, I or J is available for output 3.

Order code for "Output; input 1" (020) →	Possible options									
Current output 4 to 20 mA HART	BA									
Current output 4 to 20 mA HART Ex i	↓	CA								
FOUNDATION Fieldbus		↓	SA							
FOUNDATION Fieldbus Ex i			↓	TA						
PROFIBUS DP				↓	LA					
PROFIBUS PA					↓	GA				
PROFIBUS PA Ex i						↓	HA			
Modbus RS485							↓	MA		
EtherNet/IP 2-port switch integrated								↓	NA	
PROFINET 2-port switch integrated									↓	RA
Order code for "Output; input 2" (021) →	↓	↓	↓	↓	↓	↓	↓	↓	↓	↓
Not assigned	A	A	A	A	A	A	A	A	A	A
Current output 0/4 to 20 mA	B		B		B	B		B	B	B
Current output 0/4 to 20 mA (Ex i)		C		C			C			
User configurable input/output ¹⁾	D		D		D	D		D	D	D
Pulse/frequency/switch output	E		E		E	E		E	E	E
Double pulse output ²⁾	F							F		
Pulse/frequency/switch output (Ex i)		G		G			G			
Relay output	H		H		H	H		H	H	H
Current input 0/4 to 20 mA	I		I		I	I		I	I	I
Status input	J		J		J	J		J	J	J
Order code for "Output; input 3" (022) →	↓	↓	↓	↓	↓	↓	↓	↓	↓	↓
Not assigned	A	A	A	A	A	A	A	A	A	A
Current output 0/4 to 20 mA	B				B			B	B	B
Current output 0/4 to 20 mA (Ex i)		C								
User configurable input/output	D				D			D	D	D
Pulse/frequency/switch output	E				E			E	E	E
Double pulse output (slave) ²⁾	F							F		
Pulse/frequency/switch output (Ex i)		G								
Relay output	H				H			H	H	H
Current input 0/4 to 20 mA	I				I			I	I	I
Status input	J				J			J	J	J

1) A specific input or output can be assigned to a user configurable input/output → 16.

2) If double pulse output (F) is selected for output/input 2 (021), only the double pulse output (F) option is available for selection for output/input 3 (022).

Output signal

HART current output

Current output	4 to 20 mA HART
Current span	Can be set to: 4 to 20 mA (active/passive)  Ex-i, passive
Open-circuit voltage	DC 28.8 V (active)
Maximum input voltage	DC 30 V (passive)
Load	250 to 700 Ω
Resolution	0.38 µA
Damping	Configurable: 0.07 to 999 s
Assignable measured variables	<ul style="list-style-type: none"> ▪ Volume flow ▪ Mass flow ▪ Corrected volume flow ▪ Flow velocity ▪ Conductivity ▪ Corrected conductivity ▪ Electronic temperature

PROFIBUS PA

PROFIBUS PA	In accordance with EN 50170 Volume 2, IEC 61158-2 (MBP), galvanically isolated
Data transmission	31.25 kbit/s
Current consumption	10 mA
Permitted supply voltage	9 to 32 V
Bus connection	With integrated reverse polarity protection

PROFIBUS DP

Signal encoding	NRZ code
Data transfer	9.6 kBaud...12 MBaud

EtherNet/IP

Standards	In accordance with IEEE 802.3
------------------	-------------------------------

PROFINET

Standards	In accordance with IEEE 802.3
------------------	-------------------------------

FOUNDATION Fieldbus

FOUNDATION Fieldbus	H1, IEC 61158-2, galvanically isolated
Data transfer	31.25 kbit/s
Current consumption	10 mA
Permitted supply voltage	9 to 32 V
Bus connection	With integrated reverse polarity protection

Modbus RS485

Physical interface	RS485 in accordance with EIA/TIA-485 standard
Terminating resistor	Integrated, can be activated via DIP switches

Current output 0/4 to 20 mA

Current output	0/4 to 20 mA
Maximum output values	22.5 mA
Current span	Can be set to: <ul style="list-style-type: none"> ▪ 4 to 20 mA (active) ▪ 0/4 to 20 mA (passive)  Ex-i, passive
Open-circuit voltage	DC 28.8 V (active)
Maximum input voltage	DC 30 V (passive)
Load	0 to 700 Ω
Resolution	0.38 µA
Damping	Adjustable: 0.07 to 999 s
Assignable measured variables	<ul style="list-style-type: none"> ▪ Volume flow ▪ Mass flow ▪ Corrected volume flow ▪ Flow velocity ▪ Conductivity ▪ Corrected conductivity ▪ Temperature ▪ Electronic temperature

Pulse/frequency/switch output

Function	Can be set to pulse, frequency or switch output
Version	Open collector Can be set to: <ul style="list-style-type: none"> ▪ Active ▪ Passive  Ex-i, passive
Maximum input values	DC 30 V, 250 mA (passive)
Open-circuit voltage	DC 28.8 V (active)
Voltage drop	For 22.5 mA: ≤ DC 2 V
Pulse output	
Maximum input values	DC 30 V, 250 mA (passive)
Maximum output current	22.5 mA (active)
Open-circuit voltage	DC 28.8 V (active)
Pulse width	Adjustable: 0.05 to 2 000 ms
Maximum pulse rate	10 000 Impulse/s
Pulse value	Adjustable
Assignable measured variables	<ul style="list-style-type: none"> ▪ Volume flow ▪ Mass flow ▪ Corrected volume flow
Frequency output	

Maximum input values	DC 30 V, 250 mA (passive)
Maximum output current	22.5 mA (active)
Open-circuit voltage	DC 28.8 V (active)
Output frequency	Adjustable: end value frequency 2 to 10 000 Hz ($f_{max} = 12\,500$ Hz)
Damping	Adjustable: 0 to 999 s
Pulse/pause ratio	1:1
Assignable measured variables	<ul style="list-style-type: none"> ▪ Volume flow ▪ Mass flow ▪ Corrected volume flow ▪ Flow velocity ▪ Conductivity ▪ Corrected conductivity ▪ Temperature ▪ Electronic temperature
Switch output	
Maximum input values	DC 30 V, 250 mA (passive)
Open-circuit voltage	DC 28.8 V (active)
Switching behavior	Binary, conductive or non-conductive
Switching delay	Adjustable: 0 to 100 s
Number of switching cycles	Unlimited
Assignable functions	<ul style="list-style-type: none"> ▪ Off ▪ On ▪ Diagnostic behavior ▪ Limit value: <ul style="list-style-type: none"> - Off - Volume flow - Mass flow - Corrected volume flow - Flow velocity - Conductivity - Corrected conductivity - Totalizer 1-3 - Temperature - Electronic temperature ▪ Flow direction monitoring ▪ Status <ul style="list-style-type: none"> - Empty pipe detection - Low flow

Double pulse output

Function	Double pulse
Version	Open collector Can be set to: <ul style="list-style-type: none"> ▪ Active ▪ Passive
Maximum input values	DC 30 V, 250 mA (passive)
Open-circuit voltage	DC 28.8 V (active)
Voltage drop	For 22.5 mA: \leq DC 2 V
Output frequency	Adjustable: 0 to 1 000 Hz
Damping	Adjustable: 0 to 999 s

Pulse/pause ratio	1:1
Assignable measured variables	<ul style="list-style-type: none"> ▪ Volume flow ▪ Mass flow ▪ Corrected volume flow ▪ Flow velocity ▪ Conductivity ▪ Corrected conductivity ▪ Temperature ▪ Electronic temperature

Relay output

Function	Switch output
Version	Relay output, galvanically isolated
Switching behavior	Can be set to: <ul style="list-style-type: none"> ▪ NO (normally open), factory setting ▪ NC (normally closed)
Maximum switching capacity (passive)	<ul style="list-style-type: none"> ▪ DC 30 V, 0.1 A ▪ AC 30 V, 0.5 A
Assignable functions	<ul style="list-style-type: none"> ▪ Off ▪ On ▪ Diagnostic behavior ▪ Limit value: <ul style="list-style-type: none"> - Off - Volume flow - Mass flow - Corrected volume flow - Flow velocity - Conductivity - Corrected conductivity - Totalizer 1-3 - Temperature - Electronic temperature ▪ Flow direction monitoring ▪ Status <ul style="list-style-type: none"> - Empty pipe detection - Low flow

User configurable input/output

One specific input or output is assigned to a user-configurable input/output (configurable I/O) during device commissioning.

The following inputs and outputs are available for assignment:

- Choice of current output: 4 to 20 mA (active), 0/4 to 20 mA (passive)
- Pulse/frequency/switch output
- Choice of current input: 4 to 20 mA (active), 0/4 to 20 mA (passive)
- Status input

The technical values correspond to those of the inputs and outputs described in this section.

Signal on alarm

Depending on the interface, failure information is displayed as follows:

HART current output

Device diagnostics	Device condition can be read out via HART Command 48
---------------------------	--

PROFIBUS PA

Status and alarm messages	Diagnostics in accordance with PROFIBUS PA Profile 3.02
Failure current FDE (Fault Disconnection Electronic)	0 mA

PROFIBUS DP

Status and alarm messages	Diagnostics in accordance with PROFIBUS PA Profile 3.02
----------------------------------	---

EtherNet/IP

Device diagnostics	Device condition can be read out in Input Assembly
---------------------------	--

PROFINET

Device diagnostics	According to "Application Layer protocol for decentralized periphery", Version 2.3
---------------------------	--

FOUNDATION Fieldbus

Status and alarm messages	Diagnostics in accordance with FF-891
Failure current FDE (Fault Disconnection Electronic)	0 mA

Modbus RS485

Failure mode	Choose from: <ul style="list-style-type: none"> ▪ NaN value instead of current value ▪ Last valid value
---------------------	---

Current output 0/4 to 20 mA

4 to 20 mA

Failure mode	Choose from: <ul style="list-style-type: none"> ▪ 4 to 20 mA in accordance with NAMUR recommendation NE 43 ▪ 4 to 20 mA in accordance with US ▪ Min. value: 3.59 mA ▪ Max. value: 22.5 mA ▪ Freely definable value between: 3.59 to 22.5 mA ▪ Actual value ▪ Last valid value
---------------------	--

0 to 20 mA

Failure mode	Choose from: <ul style="list-style-type: none"> ▪ Maximum alarm: 22 mA ▪ Freely definable value between: 0 to 20.5 mA
---------------------	---

Pulse/frequency/switch output

Pulse output	
Failure mode	Choose from: <ul style="list-style-type: none"> ▪ Actual value ▪ No pulses
Frequency output	
Failure mode	Choose from: <ul style="list-style-type: none"> ▪ Actual value ▪ 0 Hz ▪ Defined value (f_{\max} 2 to 12 500 Hz)
Switch output	
Failure mode	Choose from: <ul style="list-style-type: none"> ▪ Current status ▪ Open ▪ Closed

Relay output

Failure mode	Choose from: <ul style="list-style-type: none"> ▪ Current status ▪ Open ▪ Closed
---------------------	---

Local display

Plain text display	With information on cause and remedial measures
Backlight	Red backlighting indicates a device error.



Status signal as per NAMUR recommendation NE 107

Interface/protocol

- Via digital communication:
 - HART protocol
 - FOUNDATION Fieldbus
 - PROFIBUS PA
 - PROFIBUS DP
 - Modbus RS485
 - EtherNet/IP
 - PROFINET
- Via service interface
 - CDI-RJ45 service interface
 - WLAN interface

Plain text display	With information on cause and remedial measures
---------------------------	---



Additional information on remote operation → 75

Web server

Plain text display	With information on cause and remedial measures
---------------------------	---

Light emitting diodes (LED)

Status information	<p>Status indicated by various light emitting diodes</p> <p>The following information is displayed depending on the device version:</p> <ul style="list-style-type: none"> ■ Supply voltage active ■ Data transmission active ■ Device alarm/error has occurred ■ EtherNet/IP network available ■ EtherNet/IP connection established ■ PROFINET network available ■ PROFINET connection established ■ PROFINET blinking feature
---------------------------	---

Ex connection data

Safety-related values

Order code for "Output; input 1"	Output type	Safety-related values "Output; input 1"	
		26 (+)	27 (-)
Option BA	Current output 4 to 20 mA HART	$U_N = 30 V_{DC}$ $U_M = 250 V_{AC}$	
Option GA	PROFIBUS PA	$U_N = 30 V_{DC}$ $U_M = 250 V_{AC}$	
Option LA	PROFIBUS DP	$U_N = 30 V_{DC}$ $U_M = 250 V_{AC}$	
Option MA	Modbus RS485	$U_N = 30 V_{DC}$ $U_M = 250 V_{AC}$	
Option SA	FOUNDATION Fieldbus	$U_N = 30 V_{DC}$ $U_M = 250 V_{AC}$	
Option NA	EtherNet/IP	$U_N = 30 V_{DC}$ $U_M = 250 V_{AC}$	
Option RA	PROFINET	$U_N = 30 V_{DC}$ $U_M = 250 V_{AC}$	

Order code for "Output; input 2"; "Output; input 3"	Output type	Safety-related values			
		Output; input 2		Output; input 3	
		24 (+)	25 (-)	22 (+)	23 (-)
Option B	Current output 4 to 20 mA	$U_N = 30 V_{DC}$ $U_M = 250 V_{AC}$			
Option D	User configurable input/ output	$U_N = 30 V_{DC}$ $U_M = 250 V_{AC}$			
Option E	Pulse/frequency/switch output	$U_N = 30 V_{DC}$ $U_M = 250 V_{AC}$			
Option F	Double pulse output	$U_N = 30 V_{DC}$ $U_M = 250 V_{AC}$			
Option H	Relay output	$U_N = 30 V_{DC}$ $I_N = 100 mA_{DC}/500 mA_{AC}$ $U_M = 250 V_{AC}$			
Option I	Current input 4 to 20 mA	$U_N = 30 V_{DC}$ $U_M = 250 V_{AC}$			
Option J	Status input	$U_N = 30 V_{DC}$ $U_M = 250 V_{AC}$			

Intrinsically safe values

Order code for "Output; input 1"	Output type	Intrinsically safe values "Output; input 1"	
		26 (+)	27 (-)
Option CA	Current output 4 to 20 mA HART Ex i	$U_i = 30\text{ V}$ $I_i = 100\text{ mA}$ $P_i = 1.25\text{ W}$ $L_i = 0$ $C_i = 0$	
Option HA	PROFIBUS PA Ex i	Ex ia ¹⁾ $U_i = 30\text{ V}$ $I_i = 570\text{ mA}$ $P_i = 8.5\text{ W}$ $L_i = 10\text{ }\mu\text{H}$ $C_i = 5\text{ nF}$	Ex ic ²⁾ $U_i = 32\text{ V}$ $I_i = 570\text{ mA}$ $P_i = 8.5\text{ W}$ $L_i = 10\text{ }\mu\text{H}$ $C_i = 5\text{ nF}$
Option TA	FOUNDATION Fieldbus Ex i	Ex ia ¹⁾ $U_i = 30\text{ V}$ $I_i = 570\text{ mA}$ $P_i = 8.5\text{ W}$ $L_i = 10\text{ }\mu\text{H}$ $C_i = 5\text{ nF}$	Ex ic ²⁾ $U_i = 32\text{ V}$ $I_i = 570\text{ mA}$ $P_i = 8.5\text{ W}$ $L_i = 10\text{ }\mu\text{H}$ $C_i = 5\text{ nF}$

1) Only available for the Zone 1; Class I, Division 1 version

2) Only available for the Zone 2; Class I, Division 2 version transmitter

Order code for "Output; input 2"; "Output; input 3"	Output type	Intrinsically safe values or NIFW values			
		Output; input 2		Output; input 3	
		24 (+)	25 (-)	22 (+)	23 (-)
Option C	Current output 4 to 20 mA Ex i	$U_i = 30\text{ V}$ $I_i = 100\text{ mA}$ $P_i = 1.25\text{ W}$ $L_i = 0$ $C_i = 0$			
Option G	Pulse/frequency/switch output Ex i	$U_i = 30\text{ V}$ $I_i = 100\text{ mA}$ $P_i = 1.25\text{ W}$ $L_i = 0$ $C_i = 0$			

Low flow cut off

The switch points for low flow cut off are user-selectable.



Galvanic isolation

The outputs are galvanically isolated from one another and from earth (PE).

Protocol-specific data**HART**



Manufacturer ID	0x11
Device type ID	0x3C
HART protocol revision	7
Device description files (DTM, DD)	Information and files under: www.endress.com
HART load	Min. 250 Ω
System integration	Information on system integration: Operating Instructions → 92. <ul style="list-style-type: none"> ■ Measured variables via HART protocol ■ Burst Mode functionality

PROFIBUS PA

Manufacturer ID	0x11
Ident number	0x156C
Profile version	3.02
Device description files (GSD, DTM, DD)	Information and files under: <ul style="list-style-type: none"> ▪ www.endress.com ▪ www.profibus.org
Supported functions	<ul style="list-style-type: none"> ▪ Identification & Maintenance Simplest device identification on the part of the control system and nameplate ▪ PROFIBUS upload/download Reading and writing parameters is up to ten times faster with PROFIBUS upload/download ▪ Condensed status Simplest and self-explanatory diagnostic information by categorizing diagnostic messages that occur
Configuration of the device address	<ul style="list-style-type: none"> ▪ DIP switches on the I/O electronics module ▪ Local display ▪ Via operating tools (e.g. FieldCare)
Compatibility with earlier model	<p>If the device is replaced, the measuring device Promag 300 supports the compatibility of the cyclic data with previous models. It is not necessary to adjust the engineering parameters of the PROFIBUS network with the Promag 300 GSD file.</p> <p>Earlier models:</p> <ul style="list-style-type: none"> ▪ Promag 50 PROFIBUS PA <ul style="list-style-type: none"> - ID No.: 1525 (hex) - Extended GSD file: EH3x1525.gsd - Standard GSD file: EH3_1525.gsd ▪ Promag 53 PROFIBUS PA <ul style="list-style-type: none"> - ID No.: 1527 (hex) - Extended GSD file: EH3x1527.gsd - Standard GSD file: EH3_1527.gsd <p> Description of the function scope of compatibility: Operating Instructions →  92.</p>
System integration	<p>Information regarding system integration: Operating Instructions →  92.</p> <ul style="list-style-type: none"> ▪ Cyclic data transmission ▪ Block model ▪ Description of the modules

PROFIBUS DP

Manufacturer ID	0x11
Ident number	0x1570
Profile version	3.02
Device description files (GSD, DTM, DD)	Information and files under: <ul style="list-style-type: none"> ▪ www.endress.com On the product page for the device: Documents/Software → Device drivers ▪ www.profibus.org
Supported functions	<ul style="list-style-type: none"> ▪ Identification & Maintenance Simplest device identification on the part of the control system and nameplate ▪ PROFIBUS upload/download Reading and writing parameters is up to ten times faster with PROFIBUS upload/download ▪ Condensed status Simplest and self-explanatory diagnostic information by categorizing diagnostic messages that occur
Configuration of the device address	<ul style="list-style-type: none"> ▪ DIP switches on the I/O electronics module ▪ Via operating tools (e.g. FieldCare)

Compatibility with earlier model	<p>If the device is replaced, the measuring device Promag 300 supports the compatibility of the cyclic data with previous models. It is not necessary to adjust the engineering parameters of the PROFIBUS network with the Promag 300 GSD file.</p> <p>Earlier models:</p> <ul style="list-style-type: none"> ▪ Promag 50 PROFIBUS DP <ul style="list-style-type: none"> - ID No.: 1546 (hex) - Extended GSD file: EH3x1546.gsd - Standard GSD file: EH3_1546.gsd ▪ Promag 53 PROFIBUS DP <ul style="list-style-type: none"> - ID No.: 1526 (hex) - Extended GSD file: EH3x1526.gsd - Standard GSD file: EH3_1526.gsd <p> Description of the function scope of compatibility: Operating Instructions →  92.</p>
System integration	<p>Information regarding system integration: Operating Instructions →  92.</p> <ul style="list-style-type: none"> ▪ Cyclic data transmission ▪ Block model ▪ Description of the modules

EtherNet/IP

Protocol	<ul style="list-style-type: none"> ▪ The CIP Networks Library Volume 1: Common Industrial Protocol ▪ The CIP Networks Library Volume 2: EtherNet/IP Adaptation of CIP
Communication type	<ul style="list-style-type: none"> ▪ 10Base-T ▪ 100Base-TX
Device profile	Generic device (product type: 0x2B)
Manufacturer ID	0x11
Device type ID	0x103C
Baud rates	Automatic ¹⁹ / ₁₀₀ Mbit with half-duplex and full-duplex detection
Polarity	Auto-polarity for automatic correction of crossed TxD and RxD pairs
Supported CIP connections	Max. 3 connections
Explicit connections	Max. 6 connections
I/O connections	Max. 6 connections (scanner)
Configuration options for measuring device	<ul style="list-style-type: none"> ▪ DIP switches on the electronics module for IP addressing ▪ Manufacturer-specific software (FieldCare) ▪ Add-on Profile Level 3 for Rockwell Automation control systems ▪ Web browser ▪ Electronic Data Sheet (EDS) integrated in the measuring device
Configuration of the EtherNet interface	<ul style="list-style-type: none"> ▪ Speed: 10 MBit, 100 MBit, auto (factory setting) ▪ Duplex: half-duplex, full-duplex, auto (factory setting)
Configuration of the device address	<ul style="list-style-type: none"> ▪ DIP switches on the electronics module for IP addressing (last octet) ▪ DHCP ▪ Manufacturer-specific software (FieldCare) ▪ Add-on Profile Level 3 for Rockwell Automation control systems ▪ Web browser ▪ EtherNet/IP tools, e.g. RSLinx (Rockwell Automation)
Device Level Ring (DLR)	Yes
System integration	<p>Information regarding system integration: Operating Instructions →  92.</p> <ul style="list-style-type: none"> ▪ Cyclic data transmission ▪ Block model ▪ Input and output groups

PROFINET

Protocol	"Application layer protocol for decentral device periphery and distributed automation", version 2.3
Communication type	100 MBit/s
Conformity class	Conformance Class B
Netload Class	Netload Class II
Baud rates	Automatic 100 Mbit/s with full-duplex detection
Cycle times	From 8 ms
Polarity	Auto-polarity for automatic correction of crossed TxD and RxD pairs
Media Redundancy Protocol (MRP)	Yes
Device profile	Application interface identifier 0xF600 Generic device
Manufacturer ID	0x11
Device type ID	0x843C
Device description files (GSD, DTM, DD)	Information and files under: <ul style="list-style-type: none"> ▪ www.endress.com On the product page for the device: Documents/Software → Device drivers ▪ www.profibus.org
Supported connections	<ul style="list-style-type: none"> ▪ 1 x AR (IO Controller AR) ▪ 1 x AR (IO-Supervisor Device AR connection allowed) ▪ 1 x Input CR (Communication Relation) ▪ 1 x Output CR (Communication Relation) ▪ 1 x Alarm CR (Communication Relation)
Configuration options for measuring device	<ul style="list-style-type: none"> ▪ DIP switches on the electronics module, for device name assignment (last part) ▪ Manufacturer-specific software (FieldCare, DeviceCare) ▪ Web browser ▪ Device master file (GSD), can be read out via the integrated Web server of the measuring device
Configuration of the device name	<ul style="list-style-type: none"> ▪ DIP switches on the electronics module, for device name assignment (last part) ▪ DCP protocol ▪ Process Device Manager (PDM) ▪ Integrated Web server
Supported functions	<ul style="list-style-type: none"> ▪ Identification & Maintenance Simple device identification via: <ul style="list-style-type: none"> - Control system - Nameplate ▪ Measured value status The process variables are communicated with a measured value status ▪ Blinking feature via the onsite display for simple device identification and assignment ▪ Device operation via operating tools (e.g. FieldCare, DeviceCare, SIMATIC PDM)
System integration	Information regarding system integration: Operating Instructions →  92. <ul style="list-style-type: none"> ▪ Cyclic data transmission ▪ Overview and description of the modules ▪ Status coding ▪ Startup configuration ▪ Factory setting:





FOUNDATION Fieldbus

Manufacturer ID	0x452B48 (hex)
Ident number	0x103C (hex)

Device revision	1
DD revision	Information and files under:
CFF revision	<ul style="list-style-type: none"> ▪ www.endress.com ▪ www.fieldbus.org
Interoperability Test Kit (ITK)	Version 6.2.0
ITK Test Campaign Number	Information: <ul style="list-style-type: none"> ▪ www.endress.com ▪ www.fieldbus.org
Link Master capability (LAS)	Yes
Choice of "Link Master" and "Basic Device"	Yes Factory setting: Basic Device
Node address	Factory setting: 247 (0xF7)
Supported functions	The following methods are supported: <ul style="list-style-type: none"> ▪ Restart ▪ ENP Restart ▪ Diagnostic ▪ Set to OOS ▪ Set to AUTO ▪ Read trend data ▪ Read event logbook
Virtual Communication Relationships (VCRs)	
Number of VCRs	44
Number of link objects in VFD	50
Permanent entries	1
Client VCRs	0
Server VCRs	10
Source VCRs	43
Sink VCRs	0
Subscriber VCRs	43
Publisher VCRs	43
Device Link Capabilities	
Slot time	4
Min. delay between PDU	8
Max. response delay	16
System integration	Information regarding system integration: Operating Instructions →  92. <ul style="list-style-type: none"> ▪ Cyclic data transmission ▪ Description of the modules ▪ Execution times ▪ Methods

Modbus RS485

Protocol	Modbus Applications Protocol Specification V1.1
Response times	<ul style="list-style-type: none"> ▪ Direct data access: typically 25 to 50 ms ▪ Auto-scan buffer (data range): typically 3 to 5 ms
Device type	Slave
Slave address range	1 to 247
Broadcast address range	0

Function codes	<ul style="list-style-type: none"> ▪ 03: Read holding register ▪ 04: Read input register ▪ 06: Write single registers ▪ 08: Diagnostics ▪ 16: Write multiple registers ▪ 23: Read/write multiple registers
Broadcast messages	Supported by the following function codes: <ul style="list-style-type: none"> ▪ 06: Write single registers ▪ 16: Write multiple registers ▪ 23: Read/write multiple registers
Supported baud rate	<ul style="list-style-type: none"> ▪ 1 200 BAUD ▪ 2 400 BAUD ▪ 4 800 BAUD ▪ 9 600 BAUD ▪ 19 200 BAUD ▪ 38 400 BAUD ▪ 57 600 BAUD ▪ 115 200 BAUD
Data transfer mode	<ul style="list-style-type: none"> ▪ ASCII ▪ RTU
Data access	Each device parameter can be accessed via Modbus RS485.  For Modbus register information
Compatibility with earlier model	If the device is replaced, the measuring device Promag 300 supports the compatibility of the Modbus registers for the process variables and the diagnostic information with the previous model Promag 53. It is not necessary to change the engineering parameters in the automation system.  Description of the function scope of compatibility: Operating Instructions →  92.
System integration	Information on system integration: Operating Instructions →  92. <ul style="list-style-type: none"> ▪ Modbus RS485 information ▪ Function codes ▪ Register information ▪ Response time ▪ Modbus data map

Power supply

Terminal assignment

Transmitter: supply voltage, input/outputs

HART

Supply voltage		Input/output 1		Input/output 2		Input/output 3	
1 (+)	2 (-)	26 (+)	27 (-)	24 (+)	25 (-)	22 (+)	23 (-)
The terminal assignment depends on the specific device version ordered →  12.							

FOUNDATION Fieldbus

Supply voltage		Input/output 1		Input/output 2		Input/output 3	
1 (+)	2 (-)	26 (A)	27 (B)	24 (+)	25 (-)	22 (+)	23 (-)
The terminal assignment depends on the specific device version ordered →  12.							

PROFIBUS PA

Supply voltage		Input/output 1		Input/output 2		Input/output 3	
1 (+)	2 (-)	26 (B)	27 (A)	24 (+)	25 (-)	22 (+)	23 (-)
The terminal assignment depends on the specific device version ordered → 12.							

PROFIBUS DP

Supply voltage		Input/output 1		Input/output 2		Input/output 3	
1 (+)	2 (-)	26 (B)	27 (A)	24 (+)	25 (-)	22 (+)	23 (-)
The terminal assignment depends on the specific device version ordered → 12.							

Modbus RS485

Supply voltage		Input/output 1		Input/output 2		Input/output 3	
1 (+)	2 (-)	26 (B)	27 (A)	24 (+)	25 (-)	22 (+)	23 (-)
The terminal assignment depends on the specific device version ordered → 12.							

PROFINET

Supply voltage		Input/output 1		Input/output 2		Input/output 3	
1 (+)	2 (-)	PROFINET (RJ45 connector)		24 (+)	25 (-)	22 (+)	23 (-)
The terminal assignment depends on the specific device version ordered → 12.							

EtherNet/IP

Supply voltage		Input/output 1		Input/output 2		Input/output 3	
1 (+)	2 (-)	EtherNet/IP (RJ45 connector)		24 (+)	25 (-)	22 (+)	23 (-)
The terminal assignment depends on the specific device version ordered → 12.							

 Terminal assignment of the remote display and operating module → 31.

Device plugs available

 Device plugs may not be used in hazardous areas!

Device plugs for fieldbus systems:

Order code for "Input; output 1"

- Option **SA** "FOUNDATION Fieldbus" → 26
- Option **GA** "PROFIBUS PA" → 27
- Option **RA** "PROFINET" → 27
- Option **NA** "EtherNet/IP" → 27

Device plug for connecting to the service interface:

Order code for "Accessory mounted"

option **NB**, adapter RJ45 M12 (service interface) → 28

Order code for "Input; output 1", option SA "FOUNDATION Fieldbus"

Order code for "Electrical connection"	Cable entry/connection → 30	
	2	3
M, 3, 4, 5	7/8" connector	-

Order code for "Input; output 1", option GA "PROFIBUS PA"

Order code for "Electrical connection"	Cable entry/connection → 30	
	2	3
L, N, P, U	Connector M12 × 1	-

Order code for "Input; output 1", option RA "PROFINET"

Order code for "Electrical connection"	Cable entry/connection → 30	
	2	3
L, N, P, U	Connector M12 × 1	-
R ^{1) 2)} , S ^{1) 2)} , T ^{1) 2)} , V ^{1) 2)}	Connector M12 × 1	Connector M12 × 1

- 1) Cannot be combined with an external WLAN antenna (order code for "Enclosed accessories", option P8) of an RJ45 M12 adapter for the service interface (order code for "Accessories mounted", option NB) or of the remote display and operating module DKX001.
- 2) Suitable for integrating the device in a ring topology.

Order code for "Input; output 1", option NA "EtherNet/IP"

Order code for "Electrical connection"	Cable entry/connection → 30	
	2	3
L, N, P, U	Connector M12 × 1	-
R ^{1) 2)} , S ^{1) 2)} , T ^{1) 2)} , V ^{1) 2)}	Connector M12 × 1	Connector M12 × 1

- 1) Cannot be combined with an external WLAN antenna (order code for "Enclosed accessories", option P8) of an RJ45 M12 adapter for the service interface (order code for "Accessories mounted", option NB) or of the remote display and operating module DKX001
- 2) Suitable for integrating the device in a ring topology.

Order code for "Accessory mounted", option NB "Adapter RJ45 M12 (service interface)"

Order code "Accessory mounted"	Cable entry/coupling → 30	
	Cable entry 2	Cable entry 3
NB	Plug M12 × 1	-

Pin assignment, device plug

FOUNDATION Fieldbus

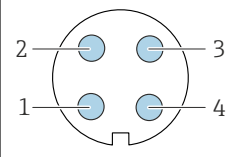
	Pin	Assignment	Coding	Plug/socket	
	1	+			Signal +
	2	-			Signal -
	3				Grounding
	4				Not assigned

PROFIBUS PA

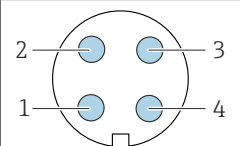
	Pin	Assignment	Coding	Plug/socket
	1	+		
2		Grounding		

	3	-	PROFIBUS PA -		
	4		Not assigned		

PROFINET

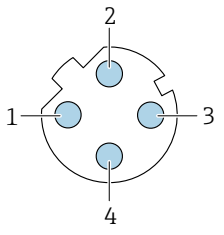
	Pin		Assignment	
	1	+	TD +	
	2	+	RD +	
	3	-	TD -	
	4	-	RD -	
	Coding		Plug/socket	
D		Socket		



Recommended plug:

- Binder, series 763, part no. 99 3729 810 04
- Phoenix, part no. 1543223 SACC-M12MSD-4Q
- When using the device in a hazardous location, use a suitably certified plug.

EtherNet/IP

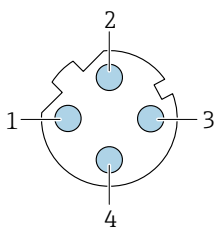
	Pin		Assignment	
	1	+	Tx	
	2	+	Rx	
	3	-	Tx	
	4	-	Rx	
	Coding		Plug/socket	
D		Socket		



Recommended plug:

- Binder, series 763, part no. 99 3729 810 04
- Phoenix, part no. 1543223 SACC-M12MSD-4Q
- When using the device in a hazardous location, use a suitably certified plug.

Service interfaceOrder code for "Accessories mounted", option **NB**: Adapter RJ45 M12 (service interface)

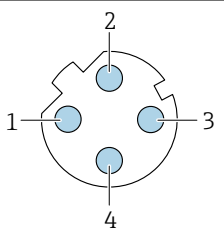
	Pin		Assignment	
	1	+	Tx	
	2	+	Rx	
	3	-	Tx	
	4	-	Rx	
	Coding		Plug/socket	
D		Socket		



Recommended plug:

- Binder, series 763, part no. 99 3729 810 04
- Phoenix, part no. 1543223 SACC-M12MSD-4Q
- When using the device in a hazardous location, use a suitably certified plug.

Supply voltage

Order code for "Power supply"	terminal voltage		Frequency range
Option D	DC24 V	±20%	-
Option E	AC100 to 240 V	-15...+10%	50/60 Hz, ±4 Hz

Order code for "Power supply"	terminal voltage		Frequency range
Option I	DC24 V	±20%	-
	AC100 to 240 V	-15...+10%	50/60 Hz, ±4 Hz

Power consumption

Transmitter

Max. 10 W (active power)

switch-on current	Max. 36 A (as per NAMUR Recommendation NE21)
--------------------------	--

Current consumption

Transmitter



- Max. 400 mA (24 V)
- Max. 200 mA (110 V, 50/60 Hz; 230 V, 50/60 Hz)

Power supply failure

- Totalizers stop at the last value measured.
- Depending on the device version, the configuration is retained in the device memory or in the pluggable data memory (HistoROM DAT).
- Error messages (incl. total operated hours) are stored.

Electrical connection

Connecting the transmitter

- i** ■ Terminal assignment →  25
- Device plugs available →  26

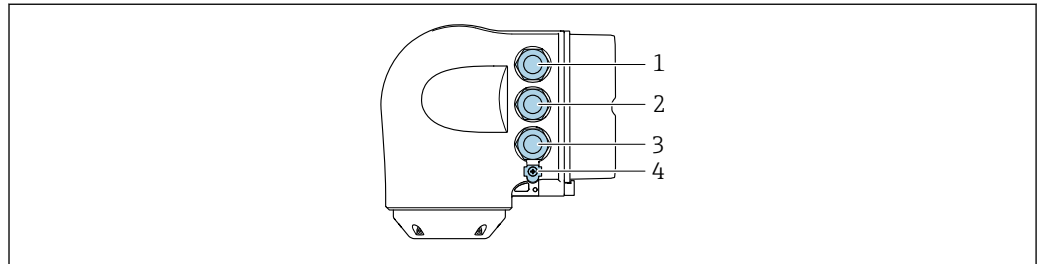

A0026781

- 1 Terminal connection for supply voltage
- 2 Terminal connection for signal transmission, input/output
- 3 Terminal connection for signal transmission, input/output or terminal for network connection via service interface (CDI-RJ45); Optional: terminal connection for external WLAN antenna or connection for remote display and operating module DKX001
- 4 Protective ground (PE)



- i** An adapter for RJ45 and the M12 connector is optionally available:
Order code for "Accessories", option **NB**: "Adapter RJ45 M12 (service interface)"

The adapter connects the service interface (CDI-RJ45) to an M12 connector mounted in the cable entry. Therefore the connection to the service interface can be established via an M12 connector without opening the device.

- i** Network connection via service interface (CDI-RJ45) →  80

Connecting in a ring topology

Device versions with EtherNet/IP and PROFINET communication protocols can be integrated into a ring topology. The device is integrated via the terminal connection for signal transmission (output 1) and the connection to the service interface (CDI-RJ45).

- i** Integrate the transmitter into a ring topology:
 - EtherNet/IP →  78
 - PROFINET →  79

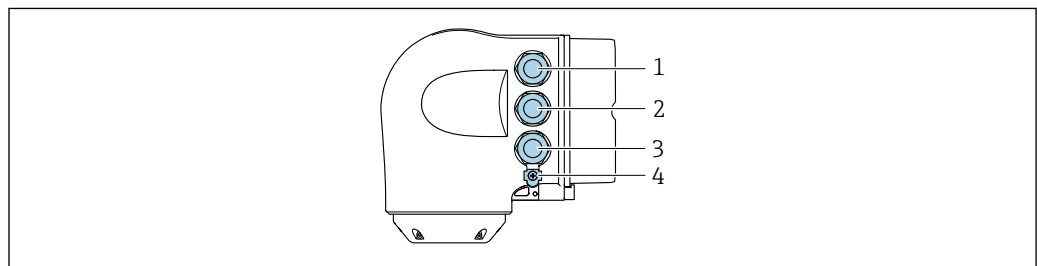

A0026781

- 1 Terminal connection for supply voltage
- 2 Terminal connection for signal transmission: PROFINET or EtherNet/IP (RJ45 connector)
- 3 Connection to service interface (CDI-RJ45)
- 4 Protective earth (PE)

- i** If the device has additional input/outputs, these are routed via the cable entry for the connection to the service interface (CDI-RJ45).

Connecting the remote display and operating module DKX001

- i** The remote display and operating module DKX001 is available as an optional extra → 89.
 - The measuring device is always supplied with a dummy cover when the remote display and operating module DKX001 is ordered directly with the measuring device. Display or operation at the transmitter is not possible in this case.
 - If ordered subsequently, the remote display and operating module DKX001 may not be connected at the same time as the existing measuring device display module. Only one display or operation unit may be connected to the transmitter at any one time.

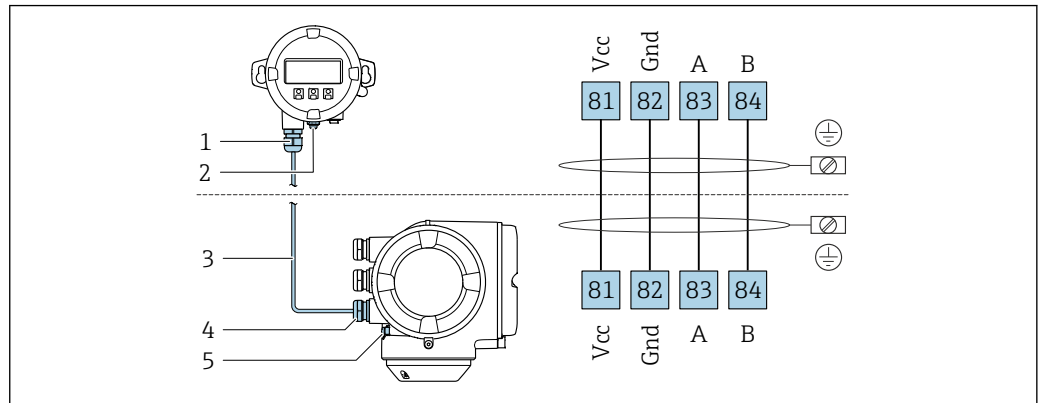

A0027518

- 1 Remote display and operating module DKX001
- 2 Protective earth (PE)
- 3 Connecting cable
- 4 Measuring device
- 5 Protective earth (PE)

Connection examples

Current output 4 to 20 mA HART

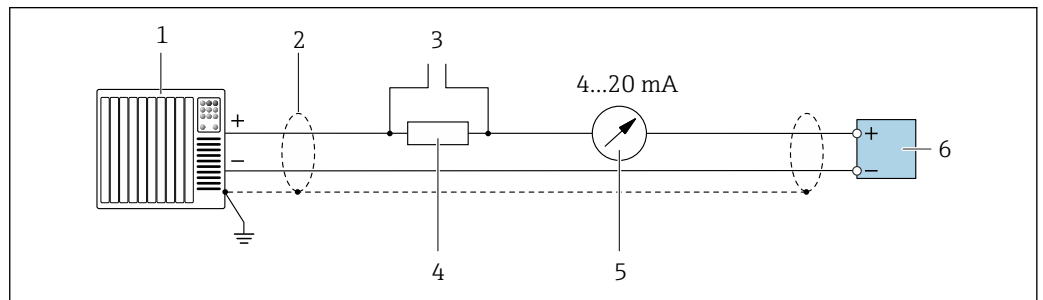

A0029055

- 2** Connection example for 4 to 20 mA HART current output (active)
- 1 Automation system with current input (e.g. PLC)
 - 2 Cable shield: the cable shield must be grounded at both ends to comply with EMC requirements; observe cable specifications → 41
 - 3 Connection for HART operating devices → 75
 - 4 Resistor for HART communication ($\geq 250 \Omega$): observe maximum load → 13
 - 5 Analog display unit: observe maximum load → 13
 - 6 Transmitter

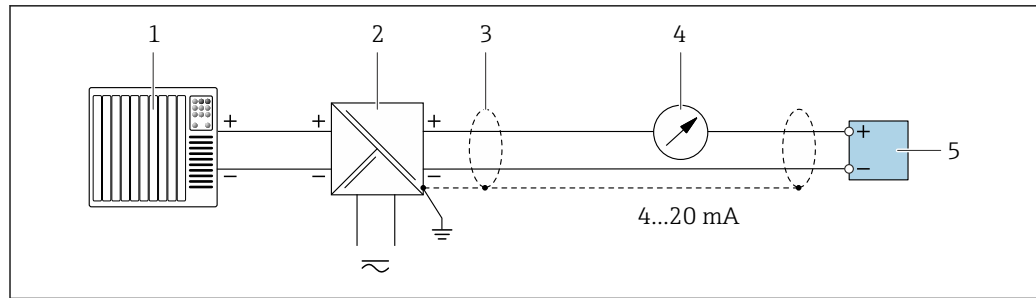

A0028762

3 Connection example for 4 to 20 mA HART current output (passive)

- 1 Automation system with current input (e.g. PLC)
- 2 Power supply
- 3 Cable shield: the cable shield must be grounded at both ends to comply with EMC requirements; observe cable specifications → 41
- 4 Analog display unit: observe maximum load → 13
- 5 Transmitter

HART input

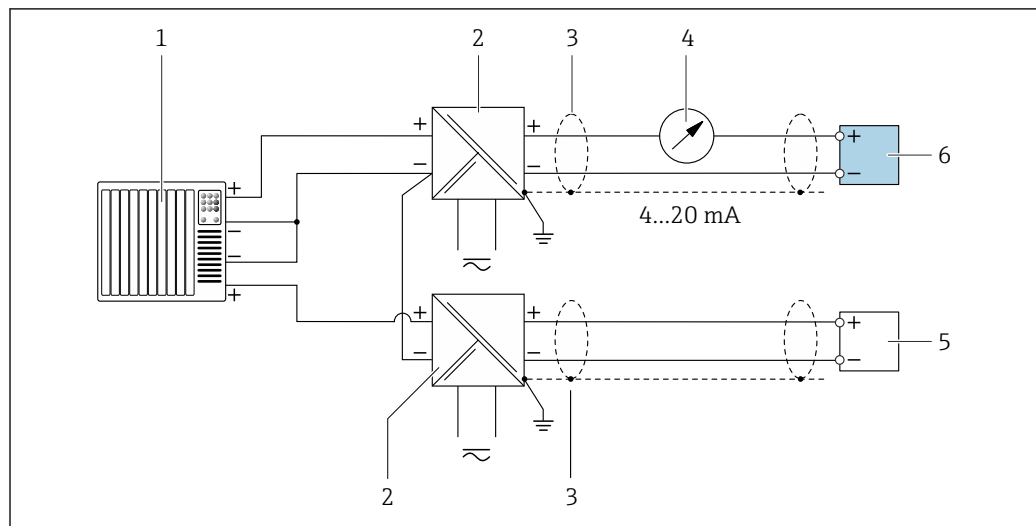

A0028763

4 Connection example for HART input with a common negative (passive)

- 1 Automation system with HART output (e.g. PLC)
- 2 Active barrier for power supply (e.g. RN221N)
- 3 Cable shield: the cable shield must be grounded at both ends to comply with EMC requirements; observe cable specifications
- 4 Analog display unit: observe maximum load
- 5 Pressure transmitter (e.g. Cerabar M, Cerabar S): see requirements
- 6 Transmitter

PROFIBUS PA

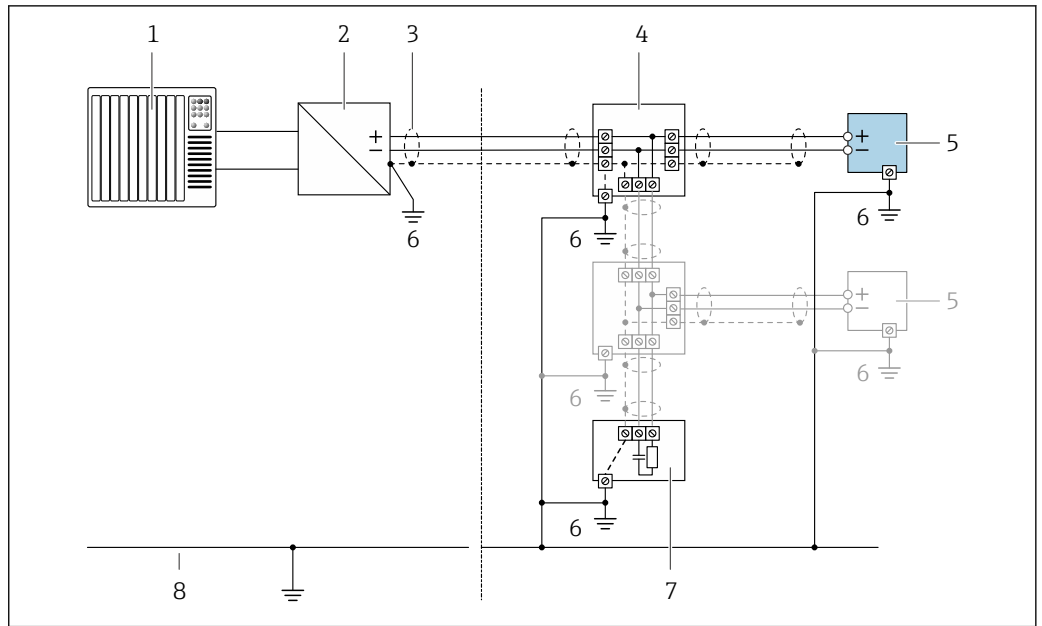

A0028768

5 Connection example for PROFIBUS PA

- 1 Control system (e.g. PLC)
- 2 PROFIBUS PA segment coupler
- 3 Cable shield: the cable shield must be grounded at both ends to comply with EMC requirements; observe cable specifications
- 4 T-box
- 5 Measuring device
- 6 Local grounding
- 7 Bus terminator
- 8 Potential matching line

PROFIBUS DP

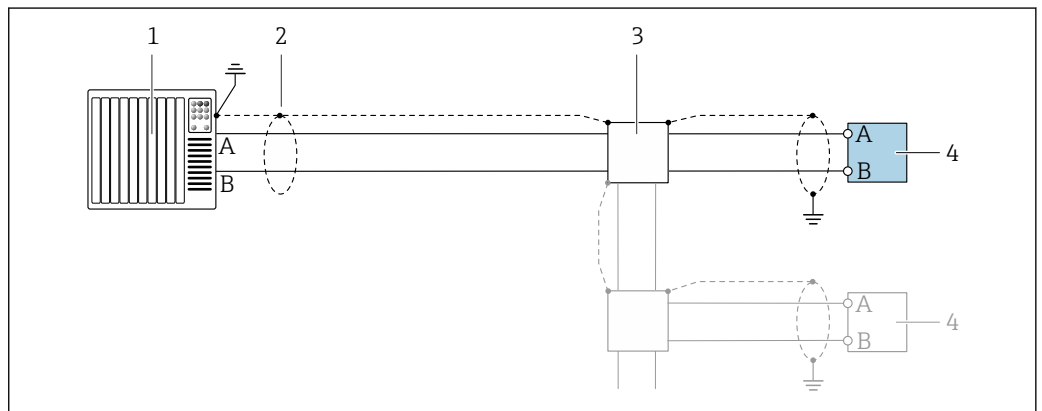

A0028765

6 Connection example for PROFIBUS DP, non-hazardous area and Zone 2/Div. 2

- 1 Control system (e.g. PLC)
- 2 Cable shield: the cable shield must be grounded at both ends to comply with EMC requirements; observe cable specifications
- 3 Distribution box
- 4 Transmitter

i If baud rates > 1.5 Mbaud an EMC cable entry must be used and the cable shield must continue as far as the terminal wherever possible.

EtherNet/IP

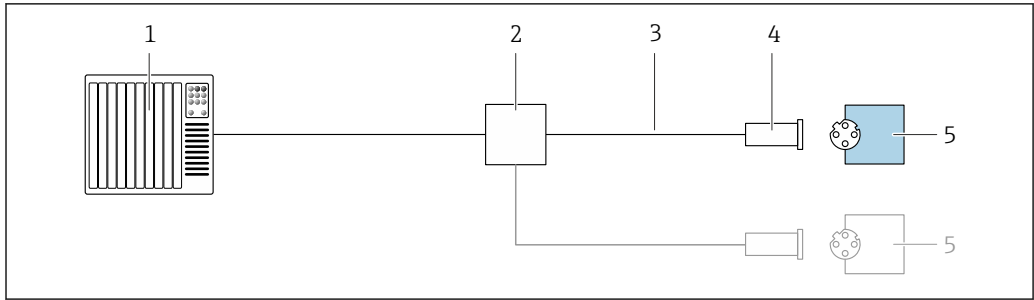

A0028767

7 Connection example for EtherNet/IP

- 1 Control system (e.g. PLC)
- 2 Ethernet switch
- 3 Observe cable specifications
- 4 Device plug
- 5 Transmitter

EtherNet/IP: DLR (Device Level Ring)

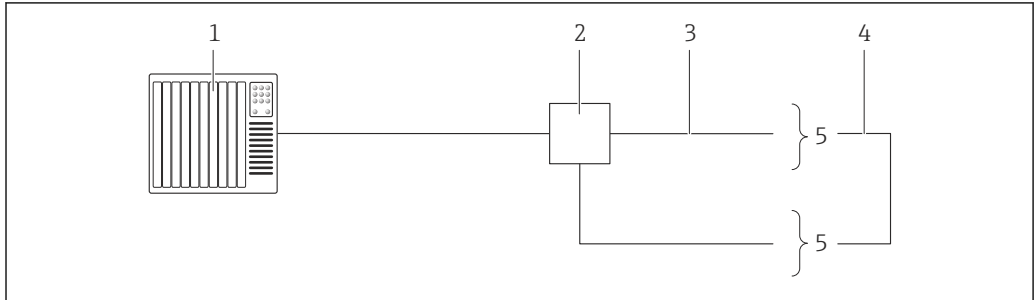

A0027544

- 1 Control system (e.g. PLC)
- 2 Ethernet switch
- 3 Observe cable specifications → 41
- 4 Connecting cable between the two transmitters
- 5 Transmitter

PROFINET

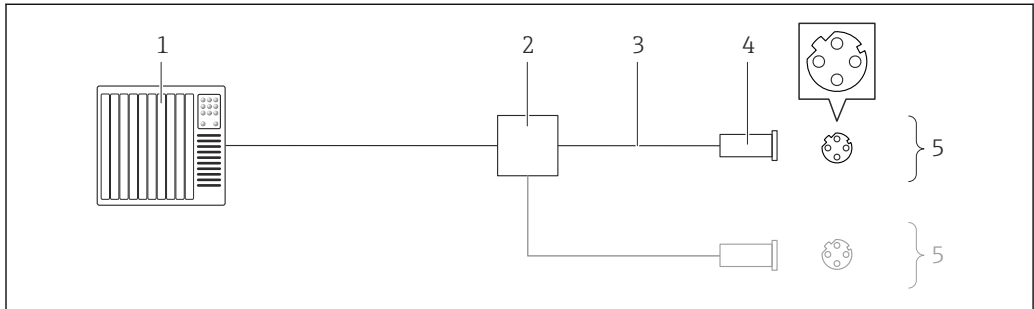

A0016805

8 Connection example for PROFINET

- 1 Control system (e.g. PLC)
- 2 Ethernet switch
- 3 Observe cable specifications
- 4 Device plug
- 5 Transmitter

PROFINET: MRP (Media Redundancy Protocol)

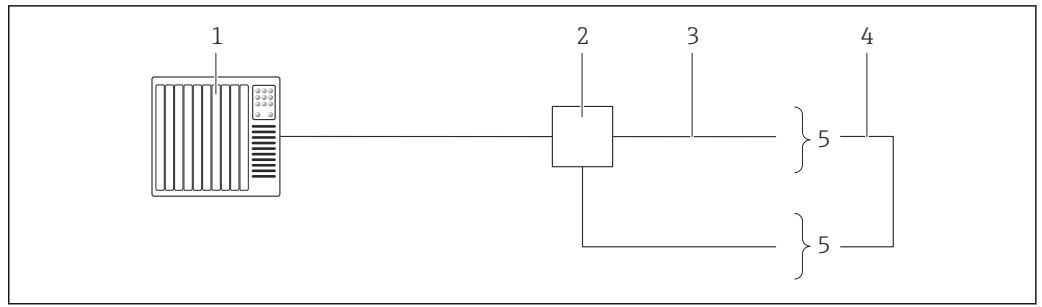

A0027544

- 1 Control system (e.g. PLC)
- 2 Ethernet switch
- 3 Observe cable specifications → 41
- 4 Connecting cable between the two transmitters
- 5 Transmitter

FOUNDATION Fieldbus

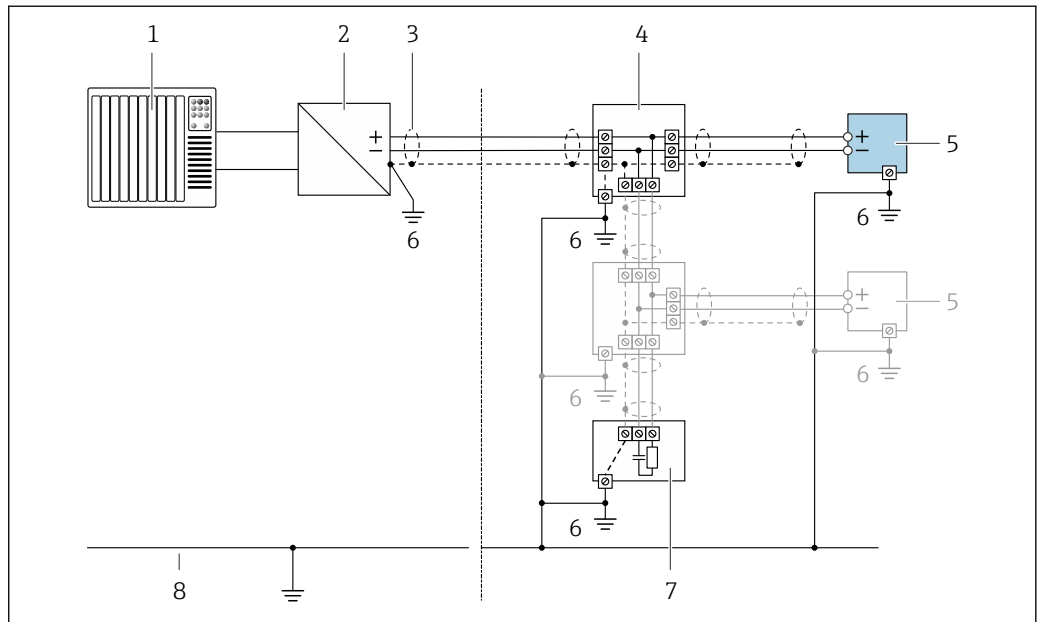

A0028768

9 Connection example for FOUNDATION Fieldbus

- 1 Control system (e.g. PLC)
- 2 Power Conditioner (FOUNDATION Fieldbus)
- 3 Cable shield: the cable shield must be grounded at both ends to comply with EMC requirements; observe cable specifications
- 4 T-box
- 5 Measuring device
- 6 Local grounding
- 7 Bus terminator
- 8 Potential matching line

Modbus RS485

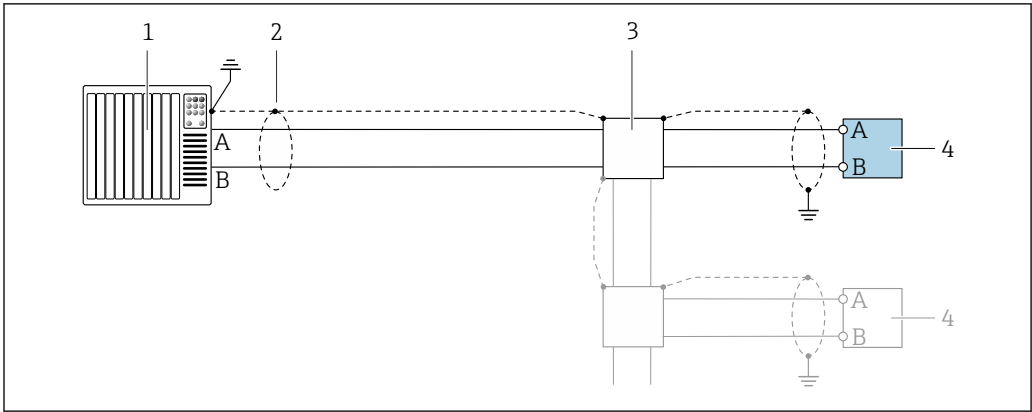

A0028765

10 Connection example for Modbus RS485, non-hazardous area and Zone 2/Div. 2

- 1 Control system (e.g. PLC)
- 2 Cable shield: the cable shield must be grounded at both ends to comply with EMC requirements; observe cable specifications
- 3 Distribution box
- 4 Transmitter

Current output 4-20 mA

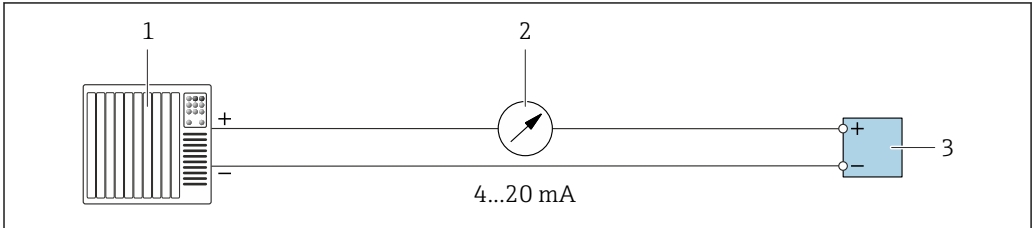

A0028758

11 Connection example for 4-20 mA current output (active)

- 1 Automation system with current input (e.g. PLC)
- 2 Analog display unit: observe maximum load
- 3 Transmitter

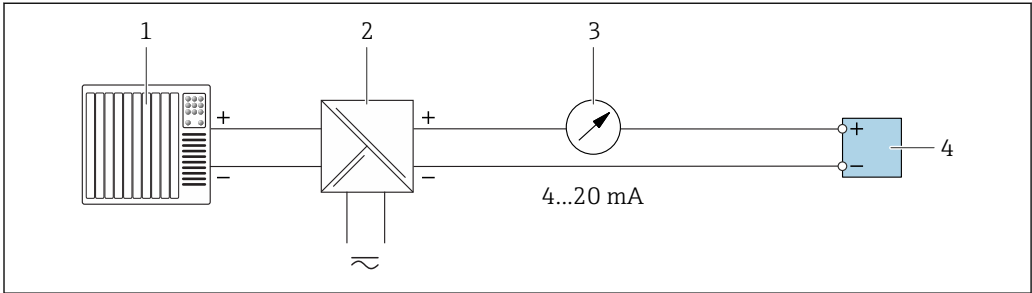

A0028759

12 Connection example for 4-20 mA current output (passive)

- 1 Automation system with current input (e.g. PLC)
- 2 Active barrier for power supply (e.g. RN221N)
- 3 Analog display unit: observe maximum load
- 4 Transmitter

Pulse/frequency output

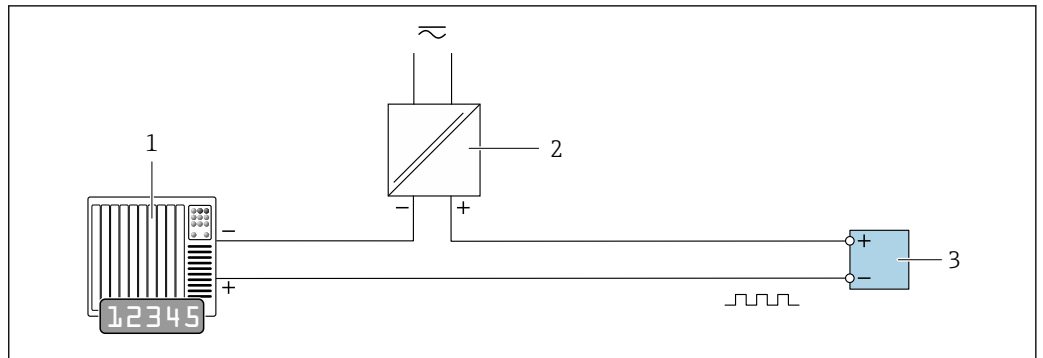

A0028761

13 Connection example for pulse/frequency output (passive)

- 1 Automation system with pulse/frequency input (e.g. PLC)
- 2 Power supply
- 3 Transmitter: Observe input values → 14

Switch output

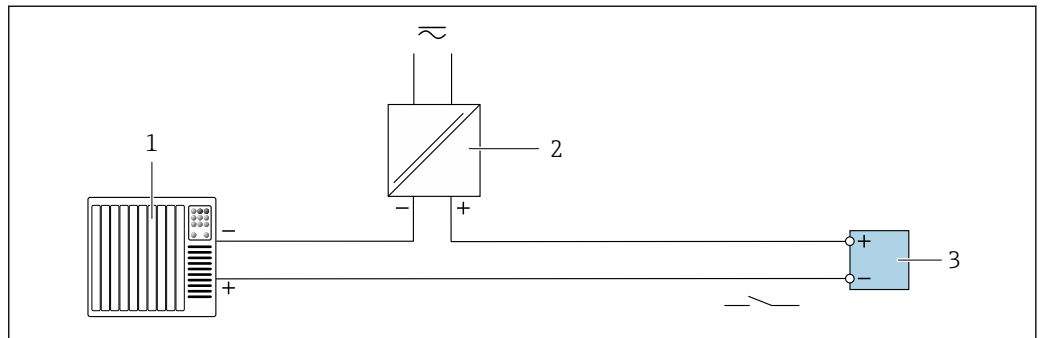

A0028760

14 Connection example for switch output (passive)

- 1 Automation system with switch input (e.g. PLC)
- 2 Power supply
- 3 Transmitter: Observe input values → 14

Double pulse output

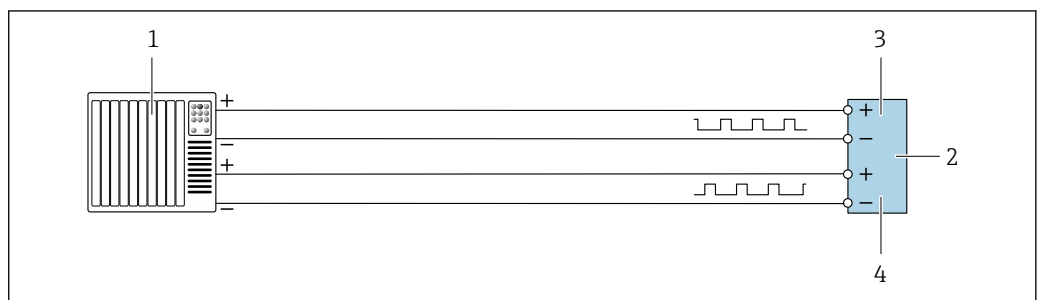

A0029280

15 Connection example for double pulse output (active)

- 1 Automation system with double pulse input (e.g. PLC)
- 2 Transmitter: Observe input values → 15
- 3 Double pulse output
- 4 Double pulse output (slave), phase-shifted

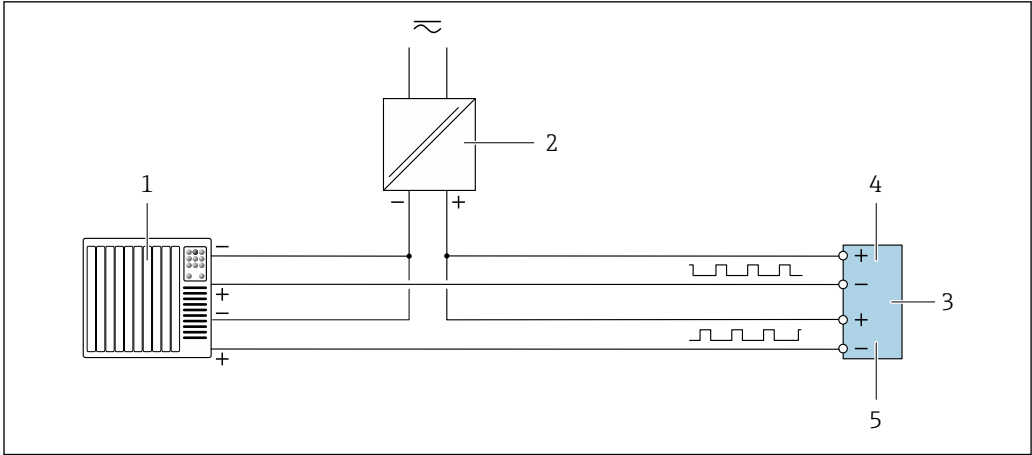

A0029279

16 Connection example for double pulse output (passive)

- 1 Automation system with double pulse input (e.g. PLC)
- 2 Power supply
- 3 Transmitter: Observe input values → 15
- 4 Double pulse output
- 5 Double pulse output (slave), phase-shifted

Relay output

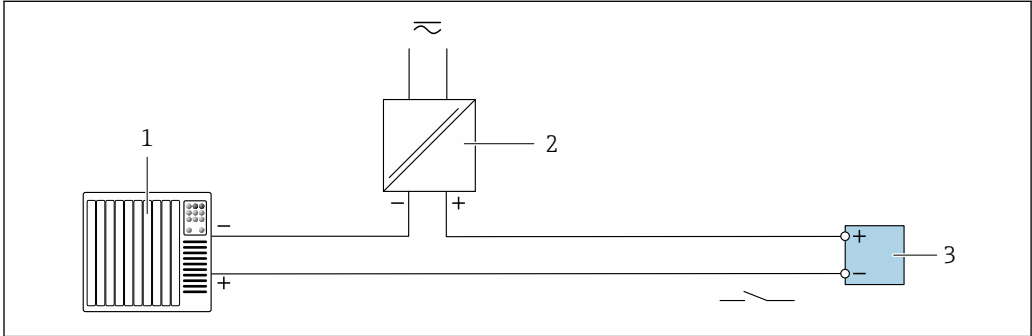

A0028760

17 Connection example for relay output (passive)

- 1 Automation system with relay input (e.g. PLC)
- 2 Power supply
- 3 Transmitter: Observe input values → 16

Current input

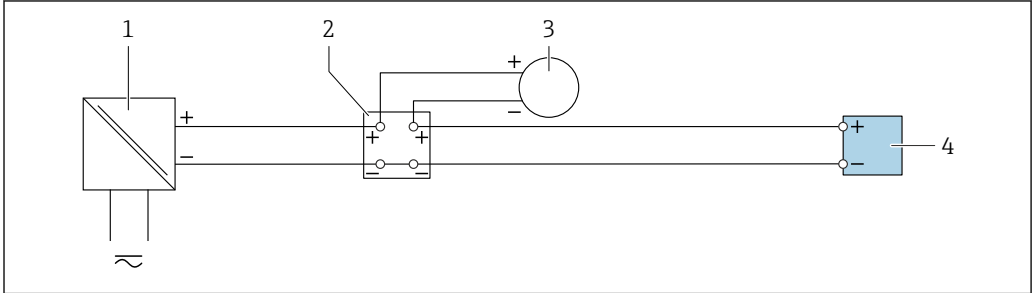

A0028915

18 Connection example for 4 to 20 mA current input

- 1 Power supply
- 2 Terminal box
- 3 External measuring device (for reading in pressure or temperature, for instance)
- 4 Transmitter

Status input

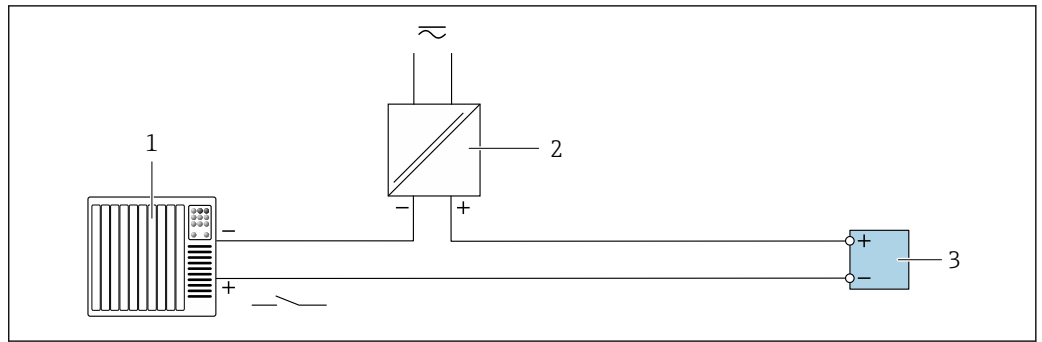

A0028764

19 Connection example for status input

- 1 Automation system with status output (e.g. PLC)
- 2 Power supply
- 3 Transmitter

Potential equalization

Requirements

Please consider the following to ensure correct measurement:

- Same electrical potential for the fluid and sensor
- Company-internal grounding concepts
- Pipe material and grounding

Connection example, standard scenario

Metal, grounded pipe

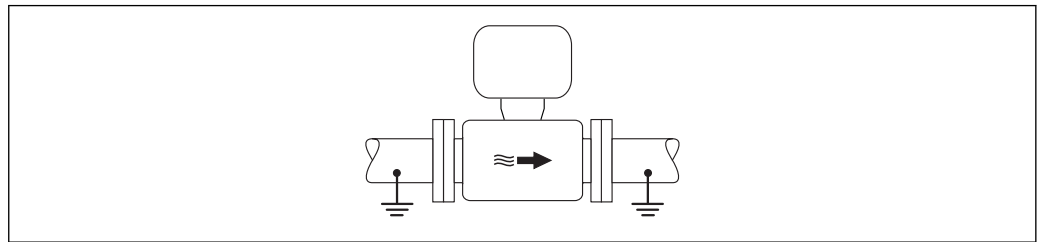

A0016315

20 Potential equalization via measuring tube

Connection example in special situations

Unlined and ungrounded metal pipe

This connection method also applies in situations where:

- The customary potential equalization is not used
- Equalizing currents are present

Ground cable	Copper wire, at least 6 mm ² (0.0093 in ²)
---------------------	---

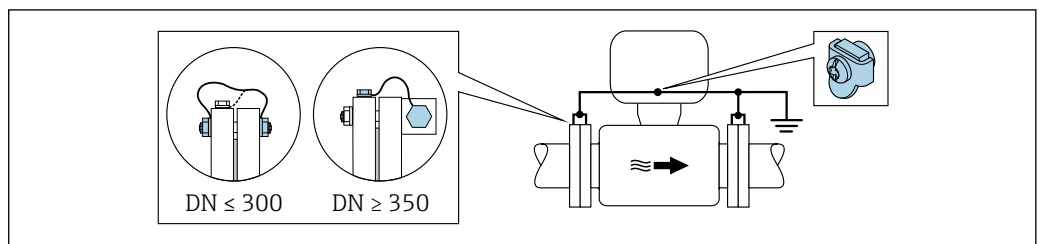



A0029338

21 Potential equalization via ground terminal and pipe flanges

Note the following when installing:

- Connect both sensor flanges to the pipe flange via a ground cable and ground them.
- Connect the connection housing of the transmitter or sensor to ground potential by means of the ground terminal provided for the purpose. To mount the ground cable:
 - If $DN \leq 300$ (12"): Mount the ground cable directly on the conductive flange coating of the sensor with the flange screws.
 - If $DN \geq 350$ (14"): Mount the ground cable directly on the metal transport bracket.

 You can order the necessary ground cable from Endress+Hauser: →  89.

Plastic pipe or pipe with insulating liner

This connection method also applies in situations where:

- The customary potential equalization is not used
- Equalizing currents are present

Ground cable	Copper wire, at least 6 mm ² (0.0093 in ²)
---------------------	---

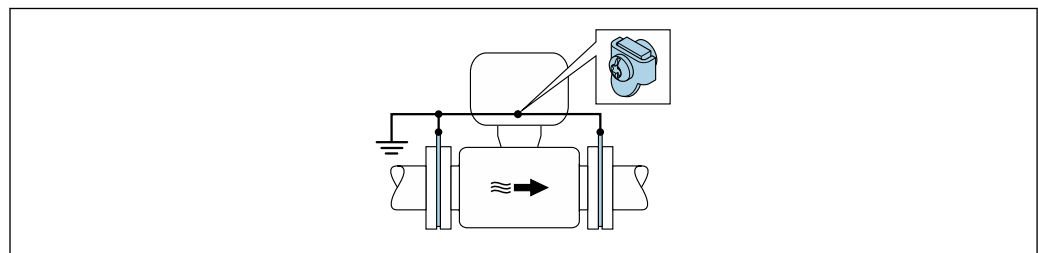

A0029339

 22 Potential equalization via ground terminal and ground disks

Note the following when installing:

The ground disks must be connected to the ground terminal via the ground cable and be connected to ground potential.

 The ground cable and ground disks can be ordered from Endress+Hauser .

Pipe with a cathodic protection unit

This connection method is only used if the following two conditions are met:

- Metal pipe without liner or pipe with electrically conductive liner
- Cathodic protection is integrated in the personal protection equipment

Ground cable	Copper wire, at least 6 mm ² (0.0093 in ²)
---------------------	---

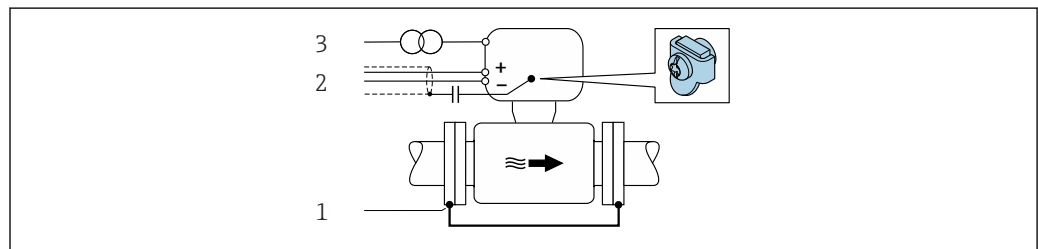



A0030377

- 1 Connection of the two flanges of the pipe via a ground cable
- 2 Signal line shielding via a capacitor
- 3 Measuring device connected to power supply such that it is floating in relation to the protective ground (isolation transformer)

Note the following when installing:

The sensor is installed in the pipe in a way that provides electrical insulation.

 You can order the necessary ground cable from Endress+Hauser: →  89.

terminals Spring-loaded terminals: Suitable for strands and strands with ferrules.
Conductor cross-section 0.2 to 2.5 mm² (24 to 12 AWG).

- Cable entries**
- Cable gland: M20 × 1.5 with cable Ø 6 to 12 mm (0.24 to 0.47 in)
 - Thread for cable entry:
 - NPT ½"
 - G ½"
 - M20
 - Device plug for digital communication: M12
Only available for certain device versions →  26.

Cable specification

Permitted temperature range

- The installation guidelines that apply in the country of installation must be observed.
- The cables must be suitable for the minimum and maximum temperatures to be expected.

Power supply cable

Standard installation cable is sufficient.

Signal cable

Current output 4 to 20 mA HART

A shielded cable is recommended. Observe grounding concept of the plant.

PROFIBUS PA

Twisted, shielded two-wire cable. Cable type A is recommended .



For further information on planning and installing PROFIBUS networks see:

- Operating Instructions "PROFIBUS DP/PA: Guidelines for planning and commissioning" (BA00034S)
- PNO Directive 2.092 "PROFIBUS PA User and Installation Guideline"
- IEC 61158-2 (MBP)

PROFIBUS DP

The IEC 61158 standard specifies two types of cable (A and B) for the bus line which can be used for every transmission rate. Cable type A is recommended.

Cable type	A
Characteristic impedance	135 to 165 Ω at a measuring frequency of 3 to 20 MHz
Cable capacitance	< 30 pF/m
Wire cross-section	> 0.34 mm ² (22 AWG)
Cable type	Twisted pairs
Loop resistance	≤ 110 Ω/km
Signal damping	Max. 9 dB over the entire length of the cable cross-section
Shield	Copper braided shielding or braided shielding with foil shield. When grounding the cable shield, observe the grounding concept of the plant.



For further information on planning and installing PROFIBUS networks see:

- Operating Instructions "PROFIBUS DP/PA: Guidelines for planning and commissioning" (BA00034S)
- PNO Directive 2.092 "PROFIBUS PA User and Installation Guideline"
- IEC 61158-2 (MBP)

EtherNet/IP

The standard ANSI/TIA/EIA-568-B.2 Annex specifies CAT 5 as the minimum category for a cable used for EtherNet/IP. CAT 5e and CAT 6 are recommended.



For more information on planning and installing EtherNet/IP networks, please refer to the "Media Planning and Installation Manual. EtherNet/IP" of ODVA Organization

PROFINET

Standard IEC 61156-6 specifies CAT 5 as the minimum category for a cable used for PROFINET. CAT 5e and CAT 6 are recommended.



For more information on planning and installing PROFINET networks, see: "PROFINET Cabling and Interconnection Technology", Guideline for PROFINET

FOUNDATION Fieldbus

Twisted, shielded two-wire cable.



For further information on planning and installing FOUNDATION Fieldbus networks see:

- Operating Instructions for "FOUNDATION Fieldbus Overview" (BA00013S)
- FOUNDATION Fieldbus Guideline
- IEC 61158-2 (MBP)

Modbus RS485

The EIA/TIA-485 standard specifies two types of cable (A and B) for the bus line which can be used for every transmission rate. Cable type A is recommended.

Cable type	A
Characteristic impedance	135 to 165 Ω at a measuring frequency of 3 to 20 MHz
Cable capacitance	< 30 pF/m
Wire cross-section	> 0.34 mm ² (22 AWG)
Cable type	Twisted pairs
Loop resistance	\leq 110 Ω /km
Signal damping	Max. 9 dB over the entire length of the cable cross-section
Shield	Copper braided shielding or braided shielding with foil shield. When grounding the cable shield, observe the grounding concept of the plant.

Current output 0/4 to 20 mA

Standard installation cable is sufficient.

Pulse/frequency/switch output

Standard installation cable is sufficient.

Double pulse output

Standard installation cable is sufficient.

Relay output

Standard installation cable is sufficient.

Current input 0/4 to 20 mA

Standard installation cable is sufficient.

Status input

Standard installation cable is sufficient.

Connecting cable for transmitter - remote display and operating module DKX001

Standard cable

A standard cable can be used as the connecting cable.

Standard cable	4 cores (2 pairs); pair-stranded with common shield
Shielding	Tin-plated copper-braid, optical cover ≥ 85 %
Capacitance: core/shield	Maximum 1 000 nF for Zone 1; Class I, Division 1
L/R	Maximum 24 µH/Ω for Zone 1; Class I, Division 1
Cable length	Maximum 300 m (1 000 ft), see the following table

Cross-section	Cable length for use in: <ul style="list-style-type: none"> ▪ Non-hazardous area ▪ Hazardous area: Zone 2; Class I, Division 2 ▪ Hazardous area: Zone 1; Class I, Division 1
0.34 mm ² (22 AWG)	80 m (270 ft)
0.50 mm ² (20 AWG)	120 m (400 ft)
0.75 mm ² (18 AWG)	180 m (600 ft)
1.00 mm ² (17 AWG)	240 m (800 ft)
1.50 mm ² (15 AWG)	300 m (1 000 ft)

Optionally available connecting cable

Standard cable	2 × 2 × 0.34 mm ² (22 AWG) PVC cable ¹⁾ with common shield (2 pairs, pair-stranded)
Flame resistance	According to DIN EN 60332-1-2
Oil-resistance	According to DIN EN 60811-2-1
Shielding	Tin-plated copper-braid, optical cover ≥ 85 %
Capacitance: core/shield	≤200 pF/m
L/R	≤24 µH/Ω
Available cable length	10 m (35 ft)
Operating temperature	When mounted in a fixed position: -50 to +105 °C (-58 to +221 °F); when cable can move freely: -25 to +105 °C (-13 to +221 °F)

1) UV radiation can impair the cable outer sheath. Protect the cable from direct sunshine where possible.

Performance characteristics

Reference operating conditions

- Error limits following DIN EN 29104, in future ISO 20456
- Water, typically: +15 to +45 °C (+59 to +113 °F); 0.5 to 7 bar (73 to 101 psi)
- Data as indicated in the calibration protocol
- Accuracy based on accredited calibration rigs according to ISO 17025

Maximum measured error

Error limits under reference operating conditions

o.r. = of reading

Volume flow

- ±0.5 % o.r. ± 1 mm/s (0.04 in/s)
- Optional: ±0.2 % o.r. ± 2 mm/s (0.08 in/s)

i Fluctuations in the supply voltage do not have any effect within the specified range.

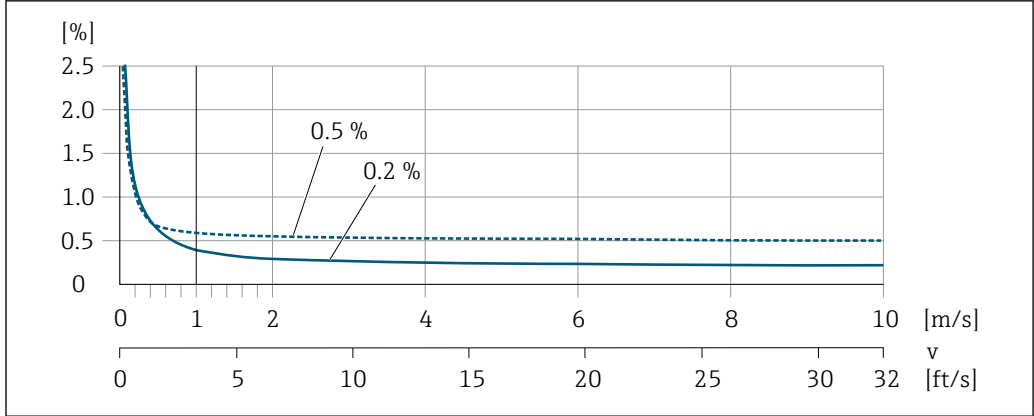

23 Maximum measured error in % o.r.

Electrical conductivity

Max. measured error not specified.

Accuracy of outputs

The outputs have the following base accuracy specifications.

Current output

Accuracy	±5 µA
-----------------	-------

Pulse/frequency output

o.r. = of reading

Accuracy	Max. ±50 ppm o.r. (over the entire ambient temperature range)
-----------------	---

Repeatability

o.r. = of reading

Volume flow

Max. ±0.1 % o.r. ± 0.5 mm/s (0.02 in/s)

Electrical conductivity

Max. ±5 % o.r.

Influence of ambient temperature

Current output

Temperature coefficient	Max. 1 µA/°C
--------------------------------	--------------

Pulse/frequency output

Temperature coefficient	No additional effect. Included in accuracy.
--------------------------------	---

Installation

No special measures such as supports etc. are necessary. External forces are absorbed by the construction of the device.

Mounting location

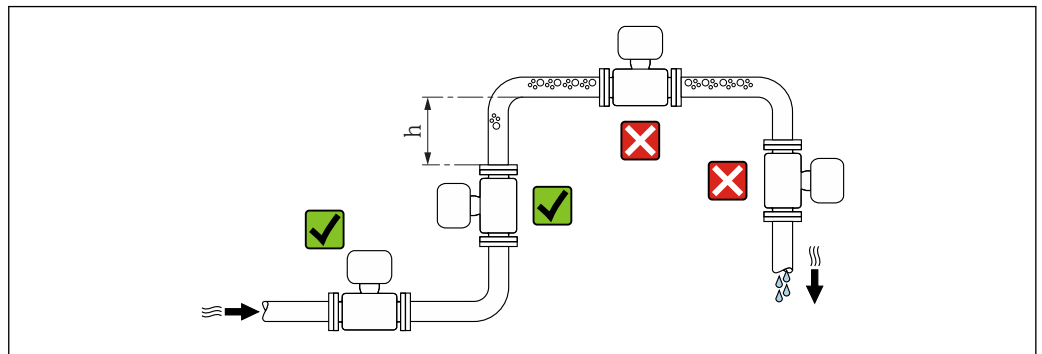

A0029343

Preferably install the sensor in an ascending pipe, and ensure a sufficient distance to the next pipe elbow: $h \geq 2 \times DN$

Installation in down pipes

Install a siphon with a vent valve downstream of the sensor in down pipes whose length $h \geq 5 \text{ m (16.4 ft)}$. This precaution is to avoid low pressure and the consequent risk of damage to the measuring tube. This measure also prevents the system losing prime.

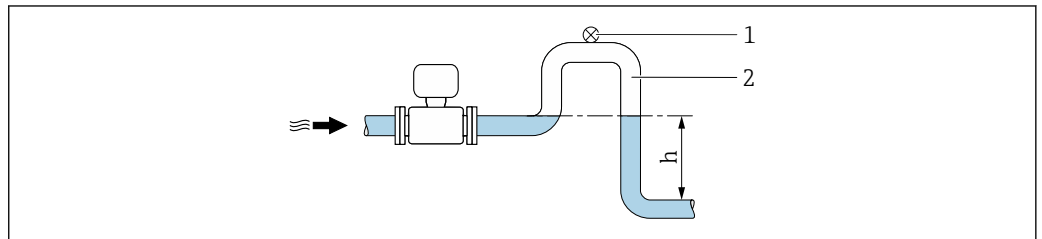

A0028981

24 Installation in a down pipe

- 1 Vent valve
- 2 Pipe siphon
- h Length of down pipe

Installation in partially filled pipes

A partially filled pipe with a gradient necessitates a drain-type configuration.

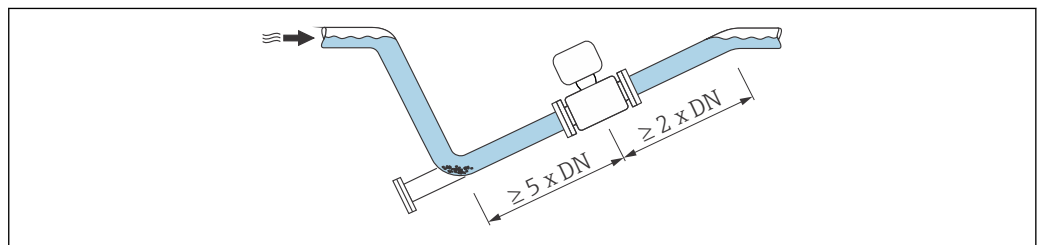

A0029257

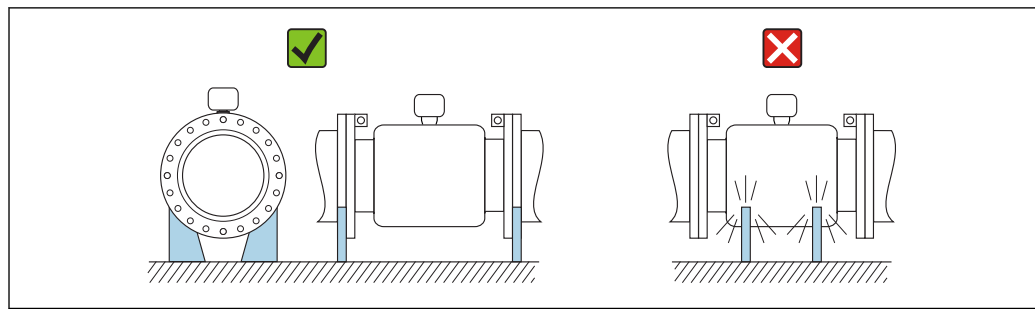

For heavy sensors DN ≥ 350 (14")



A0016276

Orientation

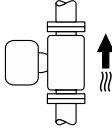
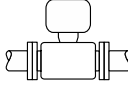
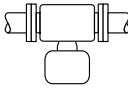
The direction of the arrow on the sensor nameplate helps you to install the sensor according to the flow direction (direction of medium flow through the piping).

Orientation		Recommendation	
A	Vertical orientation	 A0015591	✓✓
B	Horizontal orientation, transmitter at top	 A0015589	✓✓ ¹⁾
C	Horizontal orientation, transmitter at bottom	 A0015590	✓✓ ^{2) 3)}
D	Horizontal orientation, transmitter at side	 A0015592	✗

- 1) Applications with low process temperatures may decrease the ambient temperature. To maintain the minimum ambient temperature for the transmitter, this orientation is recommended.
- 2) Applications with high process temperatures may increase the ambient temperature. To maintain the maximum ambient temperature for the transmitter, this orientation is recommended.
- 3) To prevent the electronics module from overheating in the case of a sharp rise in temperature (e.g. CIP or SIP processes), install the device with the transmitter component pointing downwards.

Horizontal

- Ideally, the measuring electrode plane should be horizontal. This prevents brief insulation of the two measuring electrodes by entrained air bubbles.
- Empty pipe detection only works if the transmitter housing is pointing upwards as otherwise there is no guarantee that the empty pipe detection function will actually respond to a partially filled or empty measuring tube.

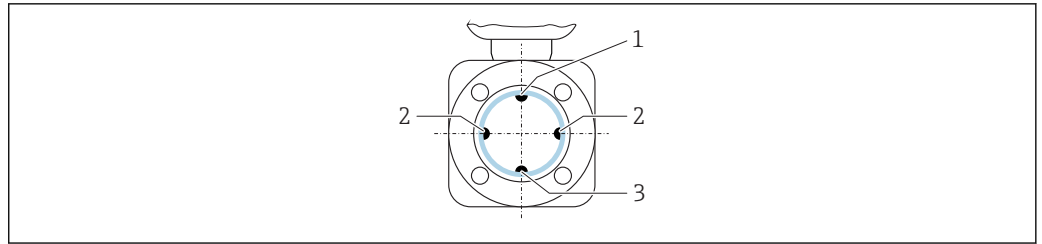

A0029344

- 1 EPD electrode for empty pipe detection
- 2 Measuring electrodes for signal detection
- 3 Reference electrode for potential equalization

i Measuring devices with tantalum or platinum electrodes can be ordered without an EPD electrode. In this case, empty pipe detection is performed via the measuring electrodes.

Inlet and outlet runs

If possible, install the sensor upstream from fittings such as valves, T-pieces or elbows. Observe the following inlet and outlet runs to comply with accuracy specifications:

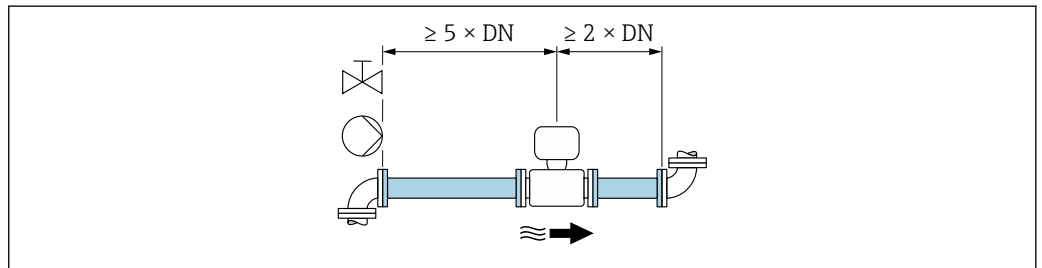

A0028997

Adapters

Suitable adapters to DIN EN 545 (double-flange reducers) can be used to install the sensor in larger-diameter pipes. The resultant increase in the rate of flow improves measuring accuracy with very slow-moving fluids.

The nomogram shown here can be used to calculate the pressure loss caused by reducers and expanders:

- Calculate the ratio of the diameters d/D .
- From the nomogram read off the pressure loss as a function of flow velocity (downstream from the reduction) and the d/D ratio.

i The nomogram only applies to liquids with a viscosity similar to that of water.

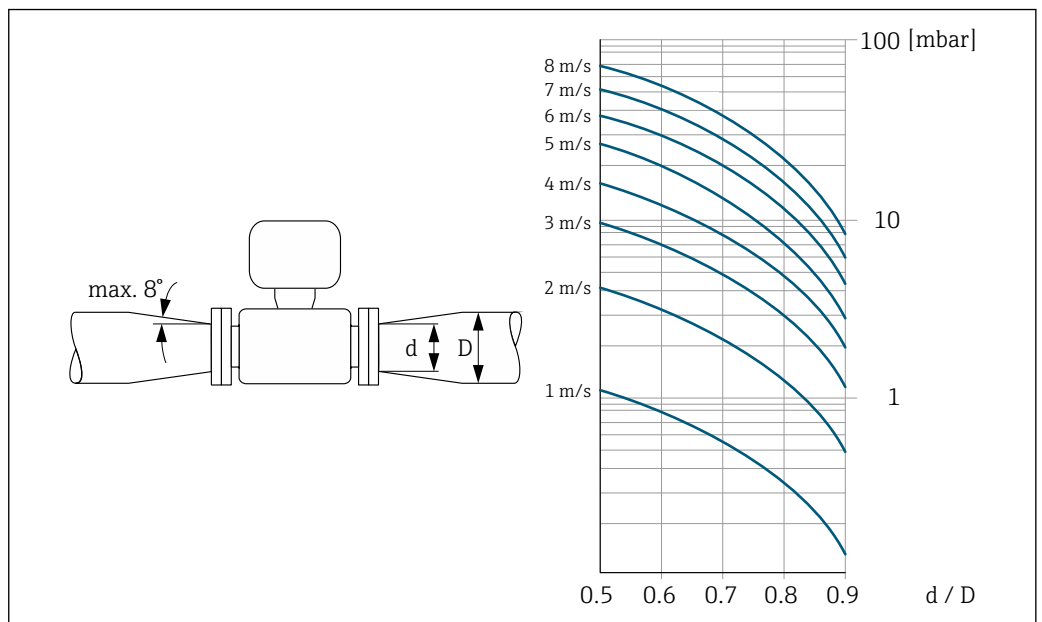

A0029002

Environment

Ambient temperature range	Transmitter	Standard: -40 to +60 °C (-40 to +140 °F)
	Local display	-20 to +60 °C (-4 to +140 °F), the readability of the display may be impaired at temperatures outside the temperature range.
	Sensor	<ul style="list-style-type: none"> ■ Process connection material, carbon steel: -10 to +60 °C (+14 to +140 °F) ■ Process connection material, stainless steel: -40 to +60 °C (-40 to +140 °F)
	Liner	Do not exceed or fall below the permitted temperature range of the liner .

If operating outdoors:

- Install the measuring device in a shady location.
- Avoid direct sunlight, particularly in warm climatic regions.
- Avoid direct exposure to weather conditions.



You can order a weather protection cover from Endress+Hauser. → 89.

Storage temperature	The storage temperature corresponds to the operating temperature range of the transmitter and the sensor → 48.
	<ul style="list-style-type: none"> ■ Protect the measuring device against direct sunlight during storage in order to avoid unacceptably high surface temperatures. ■ Select a storage location where moisture cannot collect in the measuring device as fungus or bacteria infestation can damage the liner. ■ If protection caps or protective covers are mounted these should never be removed before installing the measuring device.

Degree of protection	Measuring device <ul style="list-style-type: none"> ■ As standard: IP66/67, type 4X enclosure ■ When housing is open: IP20, type 1 enclosure ■ Display module: IP20, type 1 enclosure
	External WLAN antenna IP67

Vibration resistance	<ul style="list-style-type: none"> ■ Oscillation, sinusoidal, following IEC 60068-2-6 <ul style="list-style-type: none"> - 2 to 8.4 Hz, 3.5 mm peak - 8.4 to 2 000 Hz, 1 g peak ■ Oscillation, broadband noise following IEC 60068-2-64 <ul style="list-style-type: none"> - 10 to 200 Hz, 0.003 g²/Hz - 200 to 2 000 Hz, 0.001 g²/Hz - Total: 1.54 g rms
----------------------	--

Shock resistance	Shock, half-sine according to IEC 60068-2-27 6 ms 50 g
------------------	---

Shock resistance	Shock due to rough handling following IEC 60068-2-31
------------------	--

Mechanical load	<ul style="list-style-type: none"> ■ Protect the transmitter housing against mechanical effects, such as shock or impact. ■ Never use the transmitter housing as a ladder or climbing aid.
-----------------	--

Electromagnetic compatibility (EMC)	<ul style="list-style-type: none"> ■ As per IEC/EN 61326 and NAMUR Recommendation 21 (NE 21) ■ Device version with PROFIBUS DP: Complies with emission limits for industry as per EN 50170 Volume 2, IEC 61784
-------------------------------------	--



The following applies for PROFIBUS DP: If baud rates > 1.5 Mbaud, an EMC cable entry must be used and the cable shield must continue as far as the terminal wherever possible.



Details are provided in the Declaration of Conformity.

Process

Medium temperature range

- -20 to +150 °C (-4 to +302 °F) for PFA, DN 25 to 200 (1 to 8")
- -20 to +180 °C (-4 to +356 °F) for PFA high-temperature, DN 25 to 200 (1 to 8")
- -40 to +130 °C (-40 to +266 °F) for PTFE, DN 15 to 600 (½ to 24")

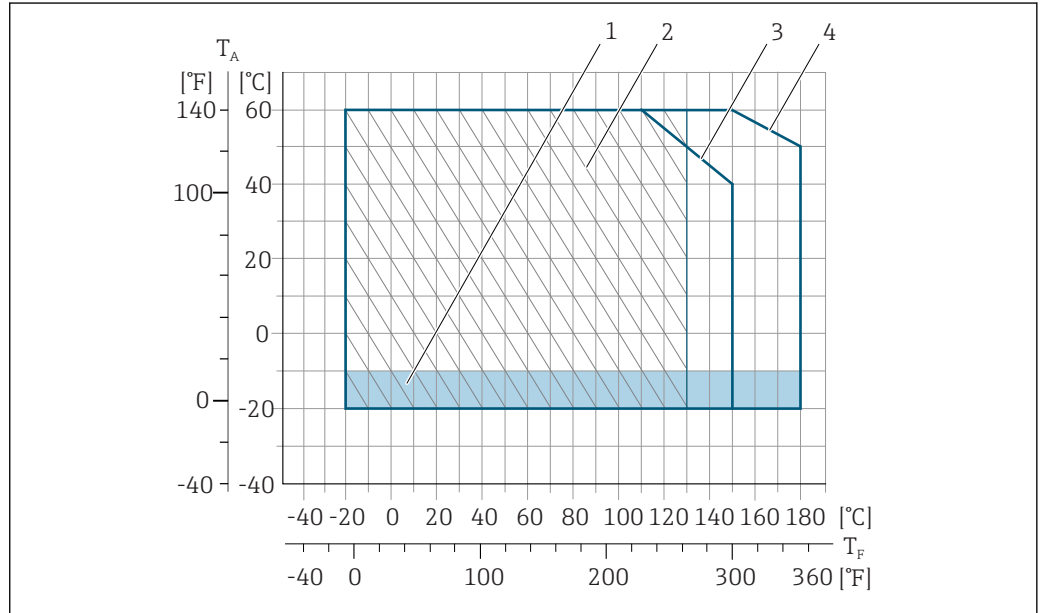

25 PFA

T_A Ambient temperature range

T_F Fluid temperature

- 1 Colored area: the ambient temperature range -10 to -20 °C (+14 to -4 °F) applies to stainless flanges only
- 2 Hatched area: harsh environment only for fluid temperature range -20 to +130 °C (-4 to +266 °F)
- 3 -20 to +150 °C (-4 to +302 °F) for PFA, DN 25 to 200 (1 to 8")
- 4 -20 to +180 °C (-4 to +356 °F) for PFA high-temperature, DN 25 to 200 (1 to 8")

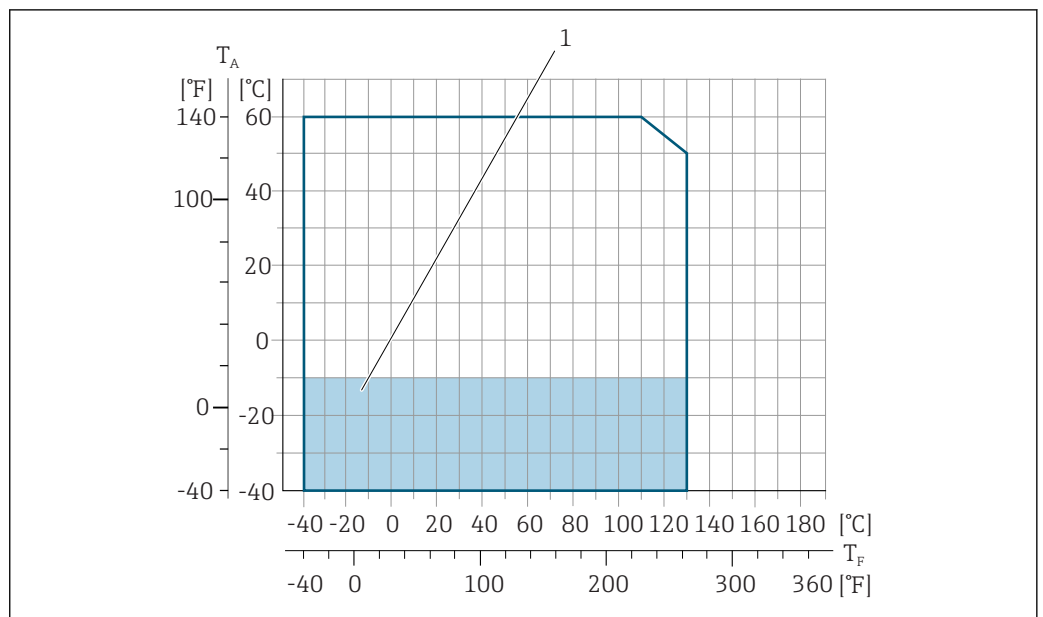

26 PTFE

T_A Ambient temperature range

T_F Fluid temperature

- 1 Colored area: the ambient temperature range of -10 to -40 °C (+14 to -40 °F) applies to stainless flanges only

Conductivity

≥ 5 µS/cm for liquids in general. Stronger filter damping is required for very low conductivity values.

Pressure-temperature ratings

The following pressure/temperature diagrams apply to all pressure-bearing parts of the device and not just the process connection. The diagrams show the maximum permissible medium pressure depending on the specific medium temperature.

Process connection: flange according to EN 1092-1 (DIN 2501)

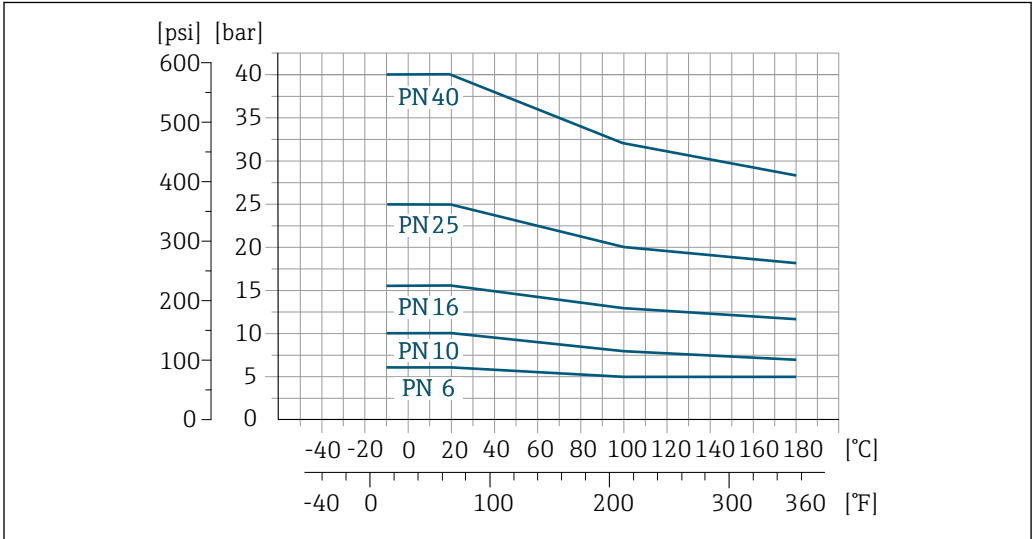

27 Process connection material: carbon steel, FE410WB/S235JRG2; Alloy C22, 2.4602 (UNS N06022)

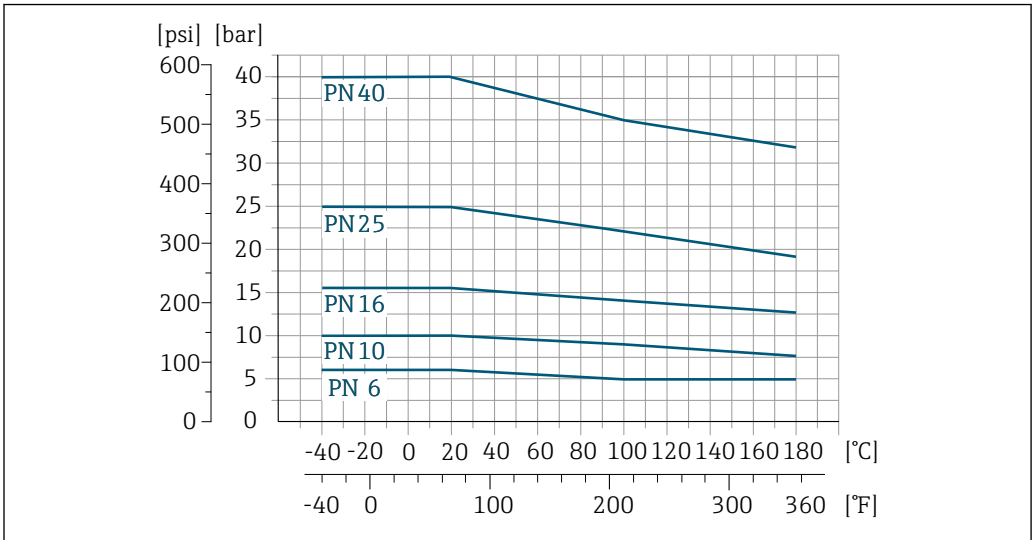

28 Process connection material: stainless steel, 1.4571 (F316L)

Process connection: flange according to ASME B16.5

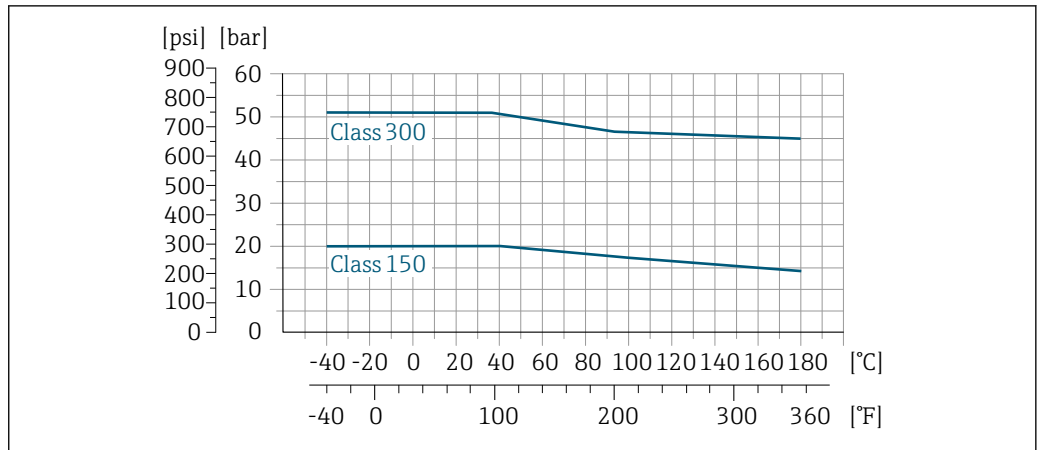

A0029393-EN

29 Process connection material: carbon steel, A105

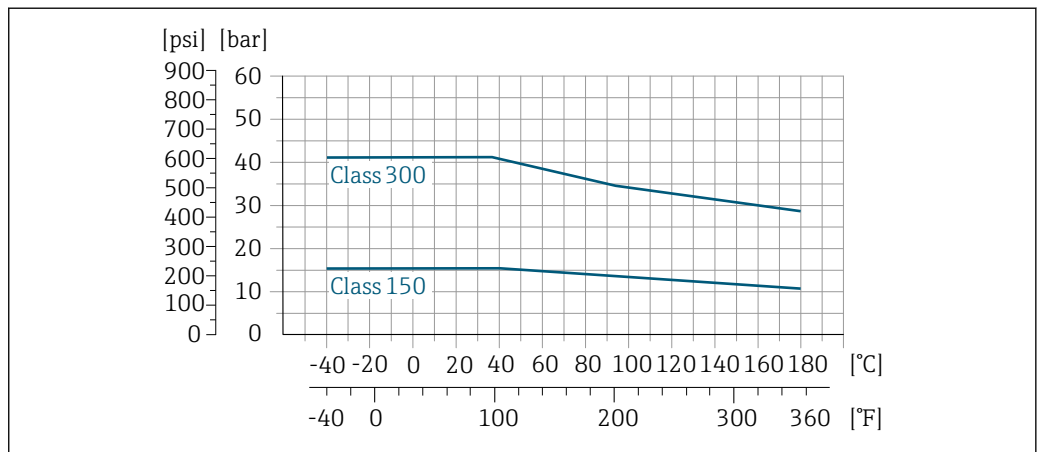

A0029394-EN

30 Process connection material: stainless steel, F316L

Process connection: flange according to JIS B2220

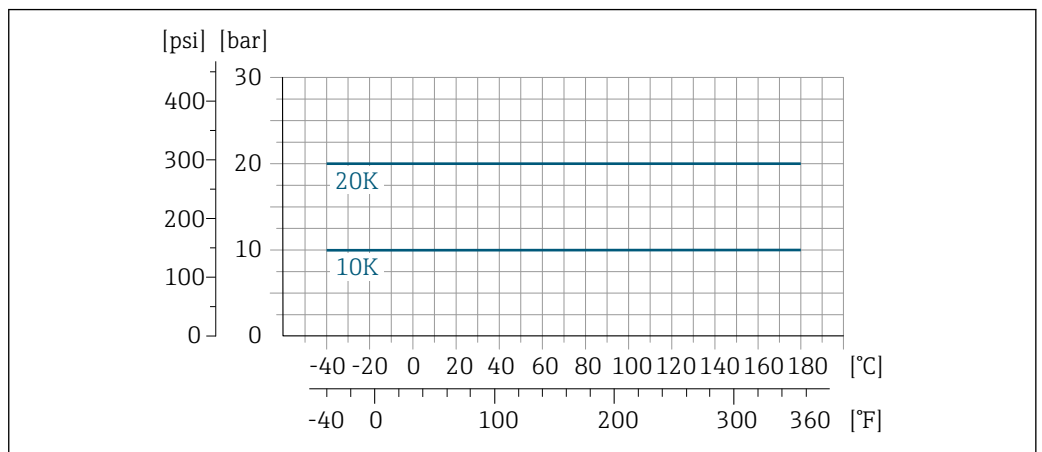

A0029397-EN

31 Process connection material: stainless steel, 1.0425 (F316L); carbon steel, S235JRG2/HII

Process connection: flange according to AS 2129 (Table E) or AS 4087 (PN 16)

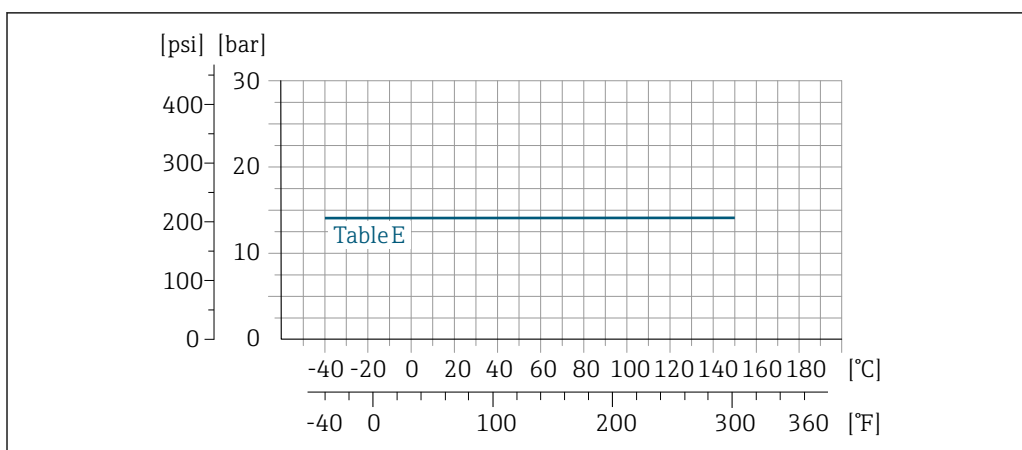

A0029398-EN

32 Process connection material: carbon steel, A105/S235JRG2/S275JR

Pressure tightness

"-" = no specifications possible

Liner: PFA

Nominal diameter		Limit values for absolute pressure in [mbar] ([psi]) for medium temperatures:		
[mm]	[in]	+25 °C (+77 °F)	+80 °C (+176 °F)	+100 to +180 °C (+212 to +356 °F)
25	1	0 (0)	0 (0)	0 (0)
32	-	0 (0)	0 (0)	0 (0)
40	1 ½	0 (0)	0 (0)	0 (0)
50	2	0 (0)	0 (0)	0 (0)
65	-	0 (0)	0 (0)	0 (0)
80	3	0 (0)	0 (0)	0 (0)
100	4	0 (0)	0 (0)	0 (0)
125	-	0 (0)	0 (0)	0 (0)
150	6	0 (0)	0 (0)	0 (0)
200	8	0 (0)	0 (0)	0 (0)

Liner: PTFE

Nominal diameter		Limit values for absolute pressure in [mbar] ([psi]) for medium temperatures:			
[mm]	[in]	+25 °C (+77 °F)	+80 °C (+176 °F)	+100 °C (+212 °F)	+130 °C (+266 °F)
15	½	0 (0)	0 (0)	0 (0)	100 (1.45)
25	1	0 (0)	0 (0)	0 (0)	100 (1.45)
32	-	0 (0)	0 (0)	0 (0)	100 (1.45)
40	1 ½	0 (0)	0 (0)	0 (0)	100 (1.45)
50	2	0 (0)	0 (0)	0 (0)	100 (1.45)
65	-	0 (0)	-	40 (0.58)	130 (1.89)
80	3	0 (0)	-	40 (0.58)	130 (1.89)
100	4	0 (0)	-	135 (1.96)	170 (2.47)
125	-	135 (1.96)	-	240 (3.48)	385 (5.58)
150	6	135 (1.96)	-	240 (3.48)	385 (5.58)
200	8	200 (2.90)	-	290 (4.21)	410 (5.95)



Nominal diameter		Limit values for absolute pressure in [mbar] ([psi]) for medium temperatures:			
[mm]	[in]	+25 °C (+77 °F)	+80 °C (+176 °F)	+100 °C (+212 °F)	+130 °C (+266 °F)
250	10	330 (4.79)	–	400 (5.80)	530 (7.69)
300	12	400 (5.80)	–	500 (7.25)	630 (9.14)
350	14	470 (6.82)	–	600 (8.70)	730 (10.6)
400	16	540 (7.83)	–	670 (9.72)	800 (11.6)
450	18	No negative pressure permitted!			
500	20				
600	24				

Flow limit

The diameter of the pipe and the flow rate determine the nominal diameter of the sensor. The optimum velocity of flow is between 2 to 3 m/s (6.56 to 9.84 ft/s). Also match the velocity of flow (v) to the physical properties of the fluid:

- v < 2 m/s (6.56 ft/s): for abrasive fluids (e.g. potter's clay, lime milk, ore slurry)
- v > 2 m/s (6.56 ft/s): for fluids producing buildup (e.g. wastewater sludge)

 A necessary increase in the flow velocity can be achieved by reducing the sensor nominal diameter.

 For an overview of the full scale values for the measuring range, see the "Measuring range" section →  9

Pressure loss

- No pressure loss occurs if the sensor is installed in a pipe with the same nominal diameter.
- Pressure losses for configurations incorporating adapters according to DIN EN 545 →  47

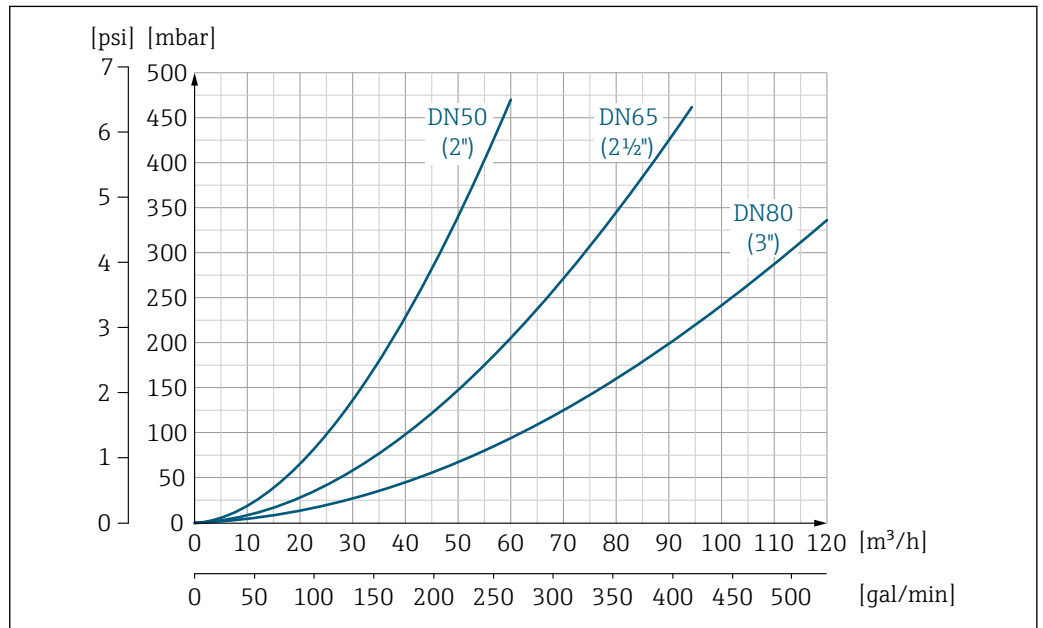

 33 Pressure loss DN 50 to 80 (2 to 3") in the case of order code for "Design", option C "Insertion length short ISO/DVGW to DN300, without inlet/outlet runs, constricted meas.tube"

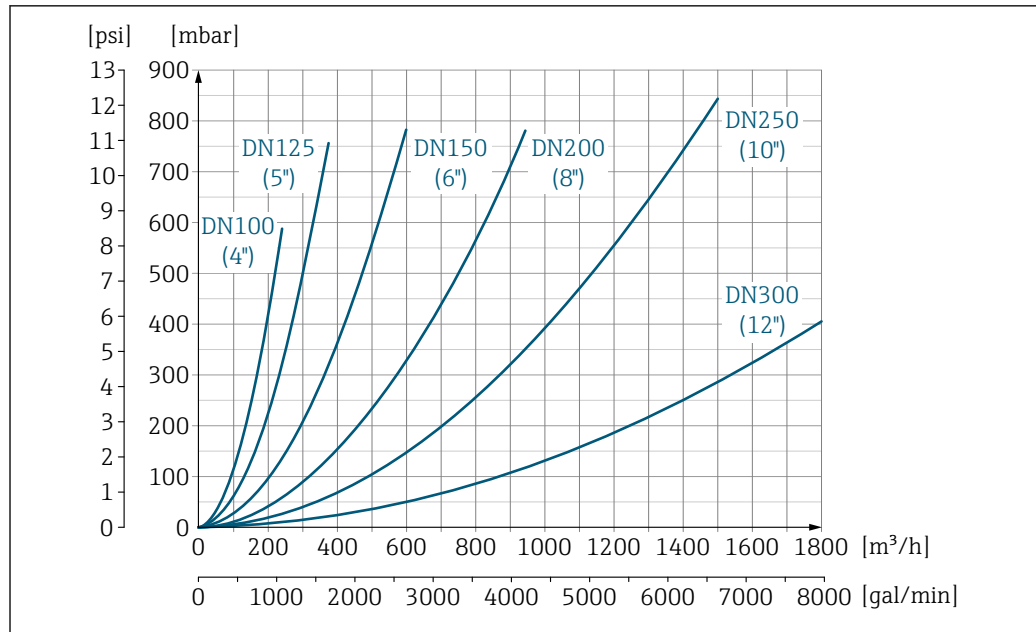

34 Pressure loss DN 100 to 300 (4 to 12") in the case of order code for "Design", option C "Insertion length short ISO/DVGW to DN300, without inlet/outlet runs, constricted meas.tube"

System pressure

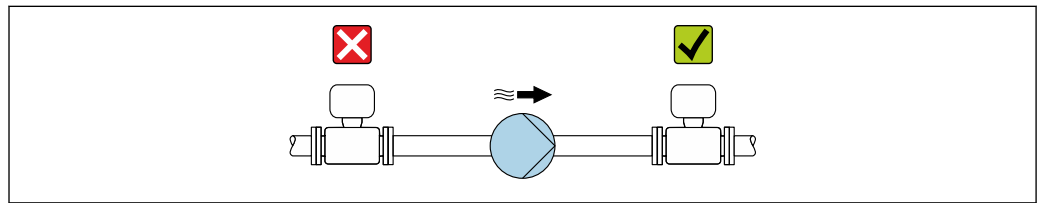

Never install the sensor on the pump suction side in order to avoid the risk of low pressure, and thus damage to the liner.

i Furthermore, install pulse dampers if reciprocating, diaphragm or peristaltic pumps are used.

- i**
 - Information on the liner's resistance to partial vacuum → 52
 - Information on the shock resistance of the measuring system → 48
 - Information on the vibration resistance of the measuring system → 48

Thermal insulation

If process fluids are very hot, it is necessary to insulate pipes in order to reduce energy loss and to prevent individuals from accidentally coming into contact with hot pipes. Please observe the applicable standards and guidelines for insulating pipes.

- i** A housing support/an extended neck is used for heat dissipation:
 - Devices with the order code for "Lining", option **B** "PFA high-temperature" always come with a housing support.
 - In the case of all other devices, a housing support can be ordered via the order code for "Sensor option", option **CG** "Sensor extended neck".

⚠ WARNING

Electronics overheating on account of thermal insulation!

- ▶ The housing support is used for heat dissipation and must be completely free (i.e. uncovered). At the very maximum, the sensor insulation may extend as far as the upper edge of the two sensor half-shells.

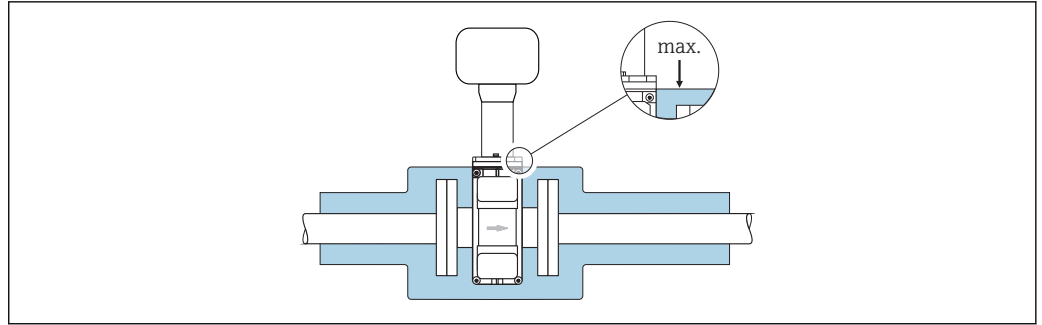

A0031216

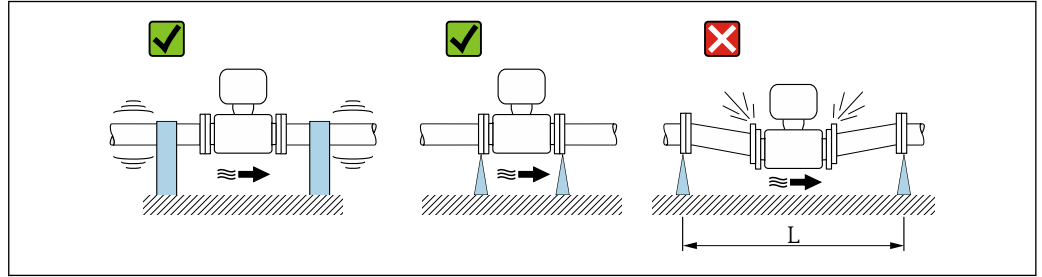

Vibrations



A0029004

35 Measures to avoid device vibrations ($L > 10\text{ m}$ (33 ft))

In the event of very strong vibrations, the pipe and sensor must be supported and fixed.

-  Information on the shock resistance of the measuring system → 48
-  Information on the vibration resistance of the measuring system → 48

Mechanical construction

Dimensions in SI units

Compact version

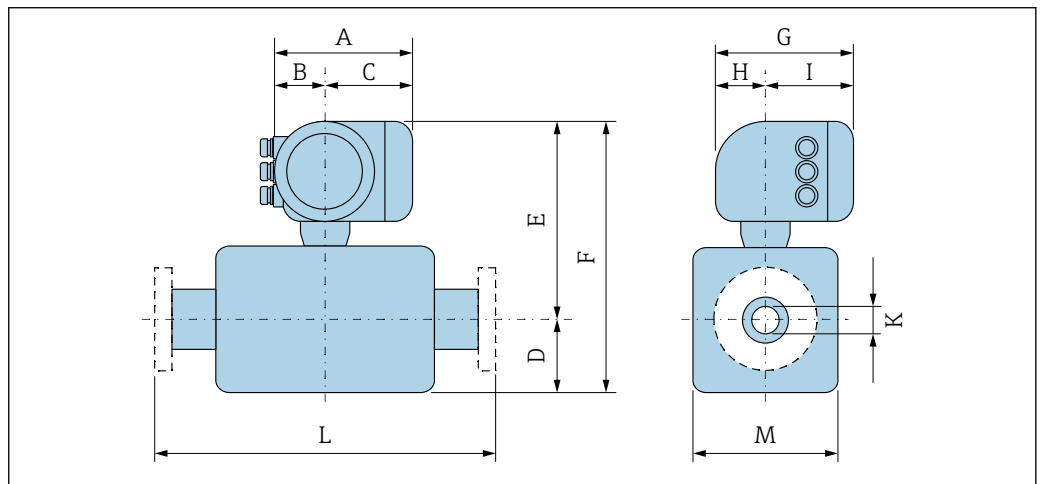

A0033783

Order code for "Housing", option A "Aluminum, coated"

DN	A ¹⁾	B ¹⁾	C	D	E ²⁾	F ²⁾	G ³⁾	H	I ³⁾	K	L	M
[mm]	[mm]	[mm]	[mm]	[mm]	[mm]	[mm]	[mm]	[mm]	[mm]	[mm]	[mm]	[mm]
15	169	68	101	84	271	355	200	59	141	⁴⁾	⁵⁾	120
25	169	68	101	84	271	355	200	59	141	⁴⁾	⁵⁾	120
32	169	68	101	84	271	355	200	59	141	⁴⁾	⁵⁾	120

DN	A ¹⁾	B ¹⁾	C	D	E ²⁾	F ²⁾	G ³⁾	H	I ³⁾	K	L	M
[mm]	[mm]	[mm]	[mm]	[mm]	[mm]	[mm]	[mm]	[mm]	[mm]	[mm]	[mm]	[mm]
40	169	68	101	84	271	355	200	59	141	⁴⁾	⁵⁾	120
50	169	68	101	84	271	355	200	59	141	⁴⁾	⁵⁾	120
65	169	68	101	109	296	405	200	59	141	⁴⁾	⁵⁾	180
80	169	68	101	109	296	405	200	59	141	⁴⁾	⁵⁾	180
100	169	68	101	109	296	405	200	59	141	⁴⁾	⁵⁾	180
125	169	68	101	150	336	486	200	59	141	⁴⁾	⁵⁾	260
150	169	68	101	150	336	486	200	59	141	⁴⁾	⁵⁾	260
200	169	68	101	180	361	541	200	59	141	⁴⁾	⁵⁾	324
250	169	68	101	205	386	591	200	59	141	⁴⁾	⁵⁾	400
300	169	68	101	230	411	641	200	59	141	⁴⁾	⁵⁾	460
350	169	68	101	282	469	751	200	59	141	⁴⁾	⁵⁾	564
400	169	68	101	308	496	804	200	59	141	⁴⁾	⁵⁾	616
450	169	68	101	333	521	854	200	59	141	⁴⁾	⁵⁾	666
500	169	68	101	359	546	905	200	59	141	⁴⁾	⁵⁾	717
600	169	68	101	411	594	1005	200	59	141	⁴⁾	⁵⁾	821

- 1) Depending on the cable gland used: values up to + 30 mm
- 2) With order code for "Sensor option", option CG "Sensor extended neck for insulation" or order code for "Liner", option B "PFA high temperature": values + 110 mm
- 3) For version without local display: values - 30 mm
- 4) Depends on the liner
- 5) Total length is independent of the process connections. Length according to DVGW (German Technical and Scientific Association for Gas and Water). → 58

Order code for "Housing", option A "Aluminum, coated"; Ex d

DN	A ¹⁾	B ¹⁾	C	D	E ²⁾	F ²⁾	G ³⁾	H	I ³⁾	K	L	M
[mm]	[mm]	[mm]	[mm]	[mm]	[mm]	[mm]	[mm]	[mm]	[mm]	[mm]	[mm]	[mm]
15	188	85	103	84	301	385	217	58	148	⁴⁾	⁵⁾	120
25	188	85	103	84	301	385	217	58	148	⁴⁾	⁵⁾	120
32	188	85	103	84	301	385	217	58	148	⁴⁾	⁵⁾	120
40	188	85	103	84	301	385	217	58	148	⁴⁾	⁵⁾	120
50	188	85	103	84	301	385	217	58	148	⁴⁾	⁵⁾	120
65	188	85	103	109	326	435	217	58	148	⁴⁾	⁵⁾	180
80	188	85	103	109	326	435	217	58	148	⁴⁾	⁵⁾	180
100	188	85	103	109	326	435	217	58	148	⁴⁾	⁵⁾	180
125	188	85	103	150	366	516	217	58	148	⁴⁾	⁵⁾	260
150	188	85	103	150	366	516	217	58	148	⁴⁾	⁵⁾	260
200	188	85	103	180	391	571	217	58	148	⁴⁾	⁵⁾	324
250	188	85	103	205	416	621	217	58	148	⁴⁾	⁵⁾	400
300	188	85	103	230	441	671	217	58	148	⁴⁾	⁵⁾	460
350	188	85	103	282	499	781	217	58	148	⁴⁾	⁵⁾	564
400	188	85	103	308	526	834	217	58	148	⁴⁾	⁵⁾	616
450	188	85	103	333	551	884	217	58	148	⁴⁾	⁵⁾	666

DN	A ¹⁾	B ¹⁾	C	D	E ²⁾	F ²⁾	G ³⁾	H	I ³⁾	K	L	M
[mm]	[mm]	[mm]	[mm]	[mm]	[mm]	[mm]	[mm]	[mm]	[mm]	[mm]	[mm]	[mm]
500	188	85	103	359	576	935	217	58	148	⁴⁾	⁵⁾	717
600	188	85	103	411	624	1035	217	58	148	⁴⁾	⁵⁾	821

- 1) Depending on the cable gland used: values up to + 30 mm
- 2) With order code for "Sensor option", option CG "Sensor extended neck for insulation" or order code for "Liner", option B "PFA high temperature": values + 110 mm
- 3) For version without local display: values - 49 mm
- 4) Depends on the liner
- 5) Total length is independent of the process connections. Length according to DVGW (German Technical and Scientific Association for Gas and Water). →  58

Flange connections

Flange

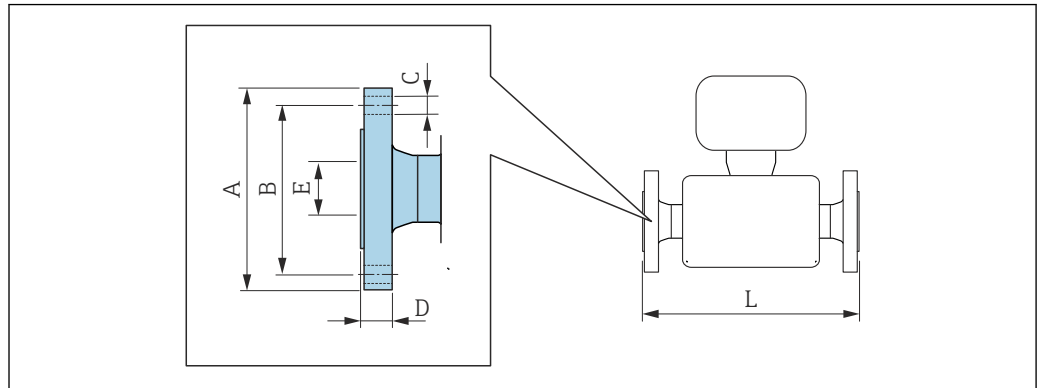

A0015621

Flange in accordance with EN 1092-1 (DIN 2501 / DIN 2512N): PN 10
P245GH (1.0352): order code for "Process connection", option D2K
1.4404 (F316/F316L): order code for "Process connection", option D2S

DN [mm]	A [mm]	B [mm]	C [mm]	D [mm]	E [mm]	L ¹⁾ [mm]
200	340	295	8 × Ø22	26	220.9	350
250	395	350	12 × Ø22	28	275.5	450
300	445	400	12 × Ø22	28	326.5	500
350	505	460	16 × Ø22	26	346	550
400	565	515	16 × Ø26	26	396	600
450	615	565	20 × Ø26	28	447	650
500	670	620	20 × Ø26	28	498	650
600	780	725	20 × Ø30	30	600	780

Surface roughness (flange): EN 1092-1 Form B1 (DIN 2526 Form C), Ra 6.3 to 12.5 µm

1) Length according to DVGW (German Technical and Scientific Association for Gas and Water).

Flange in accordance with EN 1092-1 (DIN 2501 / DIN 2512N): PN 16
P245GH (1.0352): order code for "Process connection", option D3K
1.4404 (F316/F316L): order code for "Process connection", option D3S

DN [mm]	A [mm]	B [mm]	C [mm]	D [mm]	E [mm]	L ¹⁾ [mm]
65	185	145	8 × Ø18	20	77.1	200
80	200	160	8 × Ø18	20	89.9	200
100	220	180	8 × Ø18	22	115.3	250
125	250	210	8 × Ø18	24	141.3	250
150	285	240	8 × Ø22	24	170.2	300
200	340	295	12 × Ø22	26	220.9	350
250	405	355	12 × Ø26	32	275.7	450
300	460	410	12 × Ø26	32	326.5	500
350	520	470	16 × Ø26	30	346	550
400	580	525	16 × Ø30	32	396	600
500	715	650	20 × Ø33	36	498	650

Flange in accordance with EN 1092-1 (DIN 2501 / DIN 2512N): PN 16						
P245GH (1.0352): order code for "Process connection", option D3K						
1.4404 (F316/F316L): order code for "Process connection", option D3S						
DN [mm]	A [mm]	B [mm]	C [mm]	D [mm]	E [mm]	L ¹⁾ [mm]
600	840	770	20 × Ø36	40	600	780
Surface roughness (flange): EN 1092-1 Form B1 (DIN 2526 Form C), Ra 6.3 to 12.5 µm						

1) Length according to DVGW (German Technical and Scientific Association for Gas and Water).

Flange in accordance with EN 1092-1 (DIN 2501 / DIN 2512N): PN 25						
P245GH (1.0352): order code for "Process connection", option D4K						
1.4404 (F316/F316L): order code for "Process connection", option D4S						
DN [mm]	A [mm]	B [mm]	C [mm]	D [mm]	E [mm]	L ¹⁾ [mm]
200	360	310	12 × Ø26	32	220.9	350
250	425	370	12 × Ø30	36	275.7	450
300	485	430	16 × Ø30	40	326.5	500
350	555	490	16 × Ø33	38	346	550
400	620	550	16 × Ø36	40	396	600
500	730	660	20 × Ø36	48	498	650
600	845	770	20 × Ø39	48	600	780
Surface roughness (flange): EN 1092-1 Form B1 (DIN 2526 Form C), Ra 6.3 to 12.5 µm						

1) Length according to DVGW (German Technical and Scientific Association for Gas and Water).

Flange in accordance with EN 1092-1 (DIN 2501 / DIN 2512N): PN 40						
P245GH (1.0352): order code for "Process connection", option D5K						
1.4404 (F316/F316L): order code for "Process connection", option D5S						
DN [mm]	A [mm]	B [mm]	C [mm]	D [mm]	E [mm]	L ¹⁾ [mm]
15	95	65	4 × Ø14	14	22.2	200
25	115	85	4 × Ø14	16	34.2	200
32	140	100	4 × Ø18	18	43	200
40	150	110	4 × Ø18	18	49.1	200
50	165	125	4 × Ø18	20	61.3	200
65	185	145	8 × Ø18	24	77.1	200
80	200	160	8 × Ø18	26	89.9	200
100	235	190	8 × Ø22	26	115.3	250
125	270	220	8 × Ø26	28	141.3	250
150	300	250	8 × Ø26	30	170.2	300
Surface roughness (flange): EN 1092-1 Form B1 (DIN 2526 Form C), Ra 6.3 to 12.5 µm						

1) Length according to DVGW (German Technical and Scientific Association for Gas and Water).

Flange according to ASME B16.5, Class 150						
A 105: order code for "Process connection", option A1K						
1.4404 (F316/F316L): order code for "Process connection", option A1S						
DN [mm]	A [mm]	B [mm]	C [mm]	D [mm]	E [mm]	L¹⁾ [mm]
15	88.9	60.5	4 × Ø16	9.6	22.3	200
25	108	79.2	4 × Ø16	12.6	34.2	200
40	127	98.6	4 × Ø16	15.9	49.1	200
50	152.4	120.7	4 × Ø19.1	17.5	61.3	200
80	190.5	152.4	4 × Ø19.1	22.3	89.9	200
100	228.6	190.5	8 × Ø19.1	22.3	115.3	250
150	279.4	241.3	8 × Ø22.4	23.8	170.2	300
200	342.9	298.5	8 × Ø22.4	26.8	220.9	350
250	406.4	362	12 × Ø25.4	29.6	275.7	450
300	482.6	431.8	12 × Ø25.4	30.2	326.5	500
350	535	476.3	12 × Ø28.6	35.4	346	550
400	595	539.8	16 × Ø28.6	37	396	600
450	635	577.9	16 × Ø31.8	40.1	447	650
500	700	635	20 × Ø31.8	43.3	498	650
600	815	749.3	20 × Ø34.9	48.1	600	780
Surface roughness (flange): Ra 6.3 to 12.5 µm						

1) Length according to DVGW (German Technical and Scientific Association for Gas and Water).

Flange according to ASME B16.5, Class 300						
A 105: order code for "Process connection", option A2K						
1.4404 (F316/F316L): order code for "Process connection", option A2S						
DN [mm]	A [mm]	B [mm]	C [mm]	D [mm]	E [mm]	L¹⁾ [mm]
15	95.3	66.5	4 × Ø16	12.6	22.3	200
25	123.9	88.9	4 × Ø19.1	15.9	34.2	200
40	155.4	114.3	4 × Ø22.4	19	49.1	200
50	165.1	127	8 × Ø19.1	20.8	61.3	200
80	209.6	168.1	8 × Ø22.4	26.8	89.9	200
100	254	200.2	8 × Ø22.4	30.2	115.3	250
150	317.5	269.7	12 × Ø22.4	35	170.2	300
Surface roughness (flange): Ra 6.3 to 12.5 µm						

1) Length according to DVGW (German Technical and Scientific Association for Gas and Water).

Flange according to JIS B2220, 10K						
A 105/A350LF2: order code for "Process connection", option N3K						
1.4404 (F316L): order code for "Process connection", option N3S						
DN [mm]	A [mm]	B [mm]	C [mm]	D [mm]	E [mm]	L¹⁾ [mm]
50	155	120	4 × Ø19	16	61.1	200
65	175	140	4 × Ø19	18	77.1	200
80	185	150	8 × Ø19	18	90	200

Flange according to JIS B2220, 10K						
A 105/A350LF2: order code for "Process connection", option N3K						
1.4404 (F316L): order code for "Process connection", option N3S						
DN [mm]	A [mm]	B [mm]	C [mm]	D [mm]	E [mm]	L ¹⁾ [mm]
100	210	175	8 × Ø19	18	115.4	250
125	250	210	8 × Ø23	20	141.2	250
150	280	240	8 × Ø23	22	169	300
200	330	290	12 × Ø23	22	220	350
250	400	355	12 × Ø25	24	274	450
300	445	400	16 × Ø25	24	325	500
Surface roughness (flange): Ra 6.3 to 12.5 µm						

1) Length according to DVGW (German Technical and Scientific Association for Gas and Water).

Flange according to JIS B2220, 20K						
A 105/A350LF2: order code for "Process connection", option N4K						
1.4404 (F316L): order code for "Process connection", option N4S						
DN [mm]	A [mm]	B [mm]	C [mm]	D [mm]	E [mm]	L ¹⁾ [mm]
15	95	70	4 × Ø15	14	22.2	200
25	125	90	4 × Ø19	16	34.5	200
32	135	100	4 × Ø19	18	43.2	200
40	140	105	4 × Ø19	18	49.1	200
50	155	120	8 × Ø19	18	61.1	200
65	175	140	8 × Ø19	20	77.1	200
80	200	160	8 × Ø23	22	90	200
100	225	185	8 × Ø23	24	115.4	250
125	270	225	8 × Ø25	26	141.2	250
150	305	260	12 × Ø25	28	169	300
200	350	305	12 × Ø25	30	220	350
250	430	380	12 × Ø27	34	274	450
300	480	430	16 × Ø27	36	325	500
Surface roughness (flange): Ra 6.3 to 12.5 µm						

1) Length according to DVGW (German Technical and Scientific Association for Gas and Water).

Accessories

Protective cover

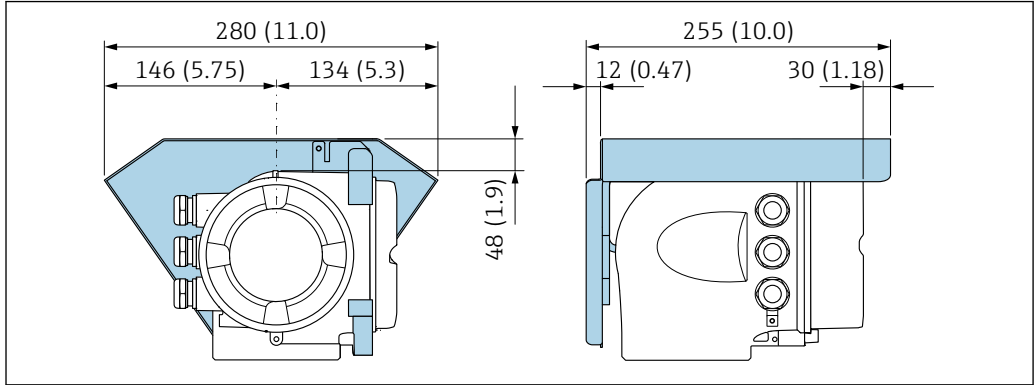

A0029553

Remote display and operating module DKX001

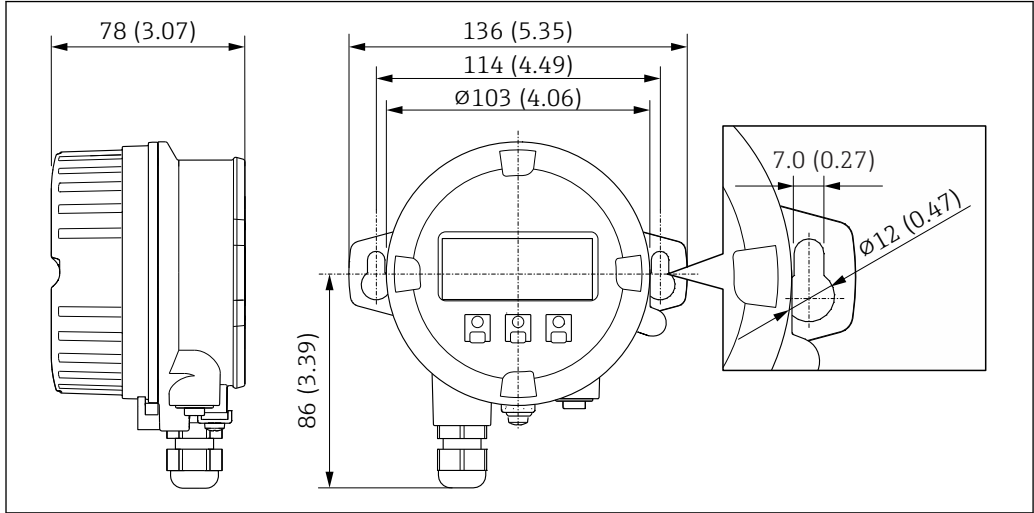

A0028921

36 Engineering unit mm (in)

External WLAN antenna

i The external WLAN antenna is not suitable for use in hygienic applications.

External WLAN antenna mounted on device

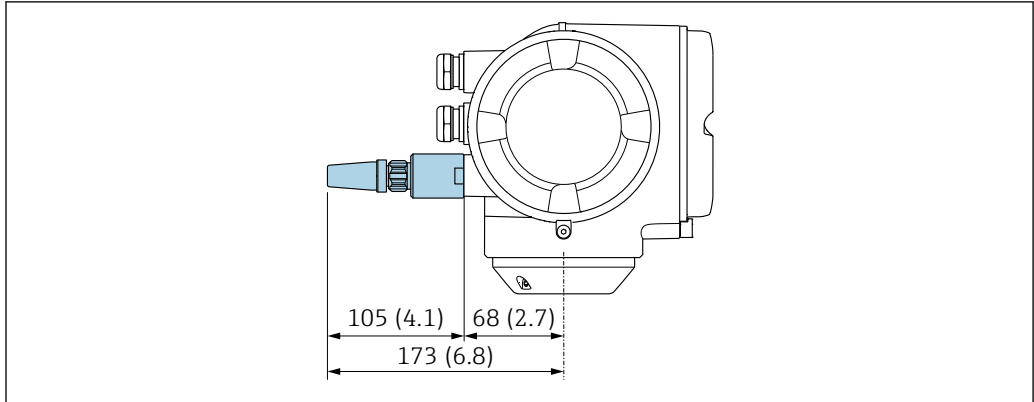

A0028923

37 Engineering unit mm (in)

External WLAN antenna mounted with cable

The external WLAN antenna can be mounted separately from the transmitter if the transmission/reception conditions at the transmitter mounting location are poor.

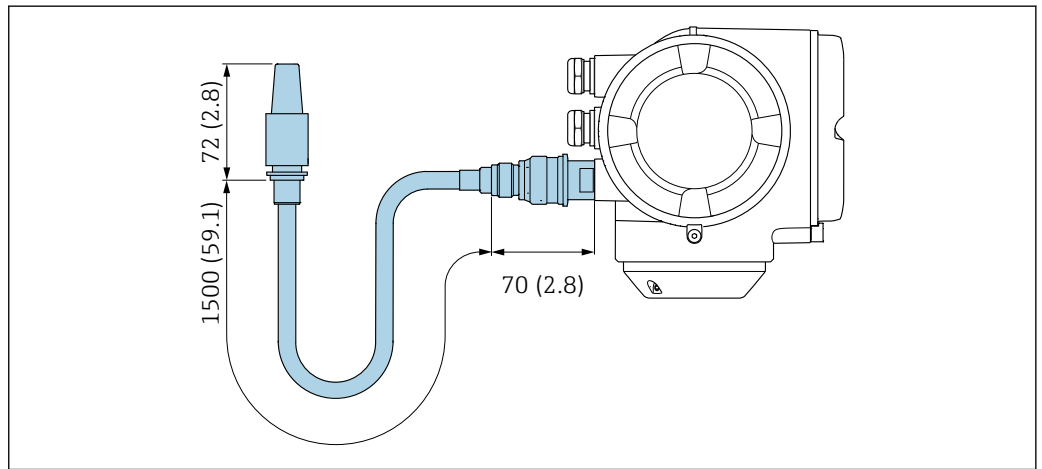

A0033597

38 Engineering unit mm (in)

Ground disk for flange connection

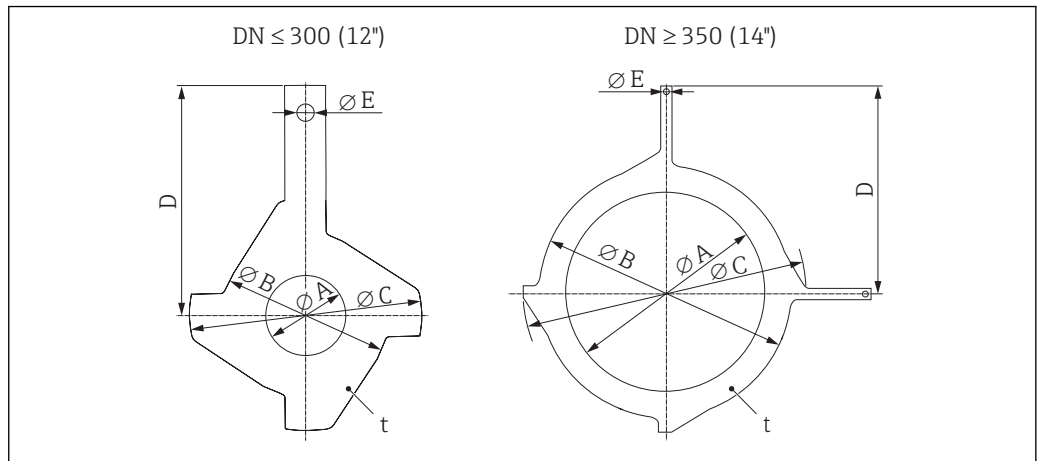

A0003221

DN ¹⁾ EN (DIN), JIS, AS ²⁾ [mm]	A PFA, PTFE [mm]	B [mm]	C [mm]	D [mm]	E [mm]	t [mm]
15	16	43	61.5	73	6.5	2
25	26	62	77.5	87.5	6.5	2
32	35	80	87.5	94.5	6.5	2
40	41	82	101	103	6.5	2
50	52	101	115.5	108	6.5	2
65	68	121	131.5	118	6.5	2
80	80	131	154.5	135	6.5	2
100	104	156	186.5	153	6.5	2
125	130	187	206.5	160	6.5	2
150	158	217	256	184	6.5	2
200	206	267	288	205	6.5	2

DN ¹⁾ EN (DIN), JIS, AS ²⁾ [mm]	A PFA, PTFE [mm]	B [mm]	C [mm]	D [mm]	E [mm]	t [mm]
250	260	328	359	240	6.5	2
300 ³⁾	312	375	413	273	6.5	2
300 ⁴⁾	310	375	404	268	6.5	2
350 ³⁾	343	433	479	365	9.0	2
400 ³⁾	393	480	542	395	9.0	2
450 ³⁾	439	538	583	417	9.0	2
500 ³⁾	493	592	650	460	9.0	2
600 ³⁾	593	693	766	522	9.0	2

1) Ground disks DN 15 to 250 (½ to 10") can be used for all available flange standards/pressure ratings.

2) For flanges to AS, only DN 25 and DN 50 are available.

3) PN 10/16

4) PN 25, JIS 10K/20K

Dimensions in US units

Compact version

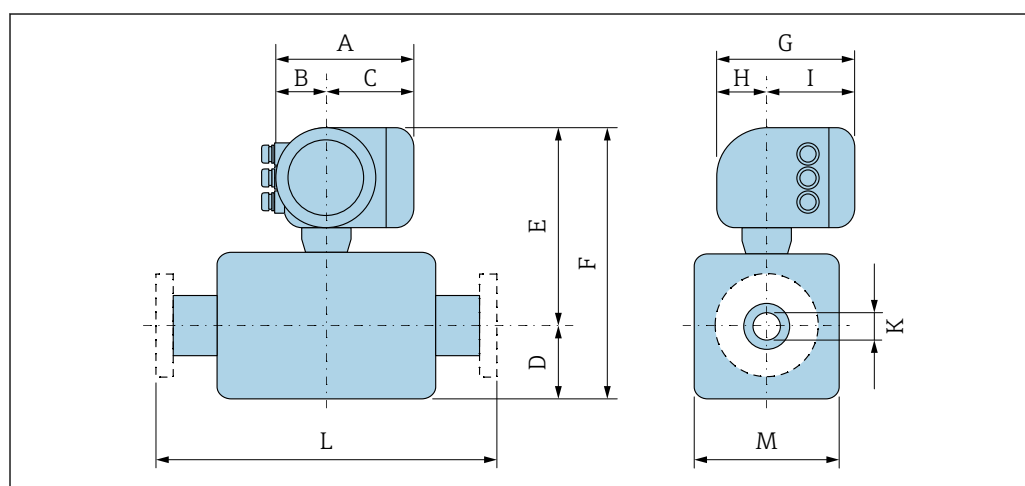

A0033785

Order code for "Housing", option A "Aluminum, coated"

DN	A ¹⁾	B ¹⁾	C	D	E ²⁾	F ²⁾	G ³⁾	H	I ³⁾	K	L	M
[in]	[in]	[in]	[in]	[in]	[in]	[in]	[in]	[in]	[in]	[in]	[in]	[in]
½	6.65	2.68	3.98	3.31	10.67	13.98	7.87	2.32	5.55	⁴⁾	⁵⁾	4.72
1	6.65	2.68	3.98	3.31	10.67	13.98	7.87	2.32	5.55	⁴⁾	⁵⁾	4.72
1 ¼	6.65	2.68	3.98	3.31	10.67	13.98	7.87	2.32	5.55	⁴⁾	⁵⁾	4.72
1 ½	6.65	2.68	3.98	3.31	10.67	13.98	7.87	2.32	5.55	⁴⁾	⁵⁾	4.72
2	6.65	2.68	3.98	3.31	10.67	13.98	7.87	2.32	5.55	⁴⁾	⁵⁾	4.72
2 ½	6.65	2.68	3.98	4.29	11.65	15.94	7.87	2.32	5.55	⁴⁾	⁵⁾	7.09
3	6.65	2.68	3.98	4.29	11.65	15.94	7.87	2.32	5.55	⁴⁾	⁵⁾	7.09
4	6.65	2.68	3.98	4.29	11.65	15.94	7.87	2.32	5.55	⁴⁾	⁵⁾	7.09
5	6.65	2.68	3.98	5.91	13.23	19.13	7.87	2.32	5.55	⁴⁾	⁵⁾	10.2
6	6.65	2.68	3.98	5.91	13.23	19.13	7.87	2.32	5.55	⁴⁾	⁵⁾	10.2
8	6.65	2.68	3.98	7.09	14.21	21.3	7.87	2.32	5.55	⁴⁾	⁵⁾	12.8
10	6.65	2.68	3.98	8.07	15.2	23.27	7.87	2.32	5.55	⁴⁾	⁵⁾	15.8

DN	A ¹⁾	B ¹⁾	C	D	E ²⁾	F ²⁾	G ³⁾	H	I ³⁾	K	L	M
[in]	[in]	[in]	[in]	[in]	[in]	[in]	[in]	[in]	[in]	[in]	[in]	[in]
12	6.65	2.68	3.98	9.06	16.18	25.24	7.87	2.32	5.55	⁴⁾	⁵⁾	18.1
14	6.65	2.68	3.98	11.1	18.46	29.57	7.87	2.32	5.55	⁴⁾	⁵⁾	22.2
16	6.65	2.68	3.98	12.13	19.53	31.65	7.87	2.32	5.55	⁴⁾	⁵⁾	24.3
18	6.65	2.68	3.98	13.11	20.51	33.62	7.87	2.32	5.55	⁴⁾	⁵⁾	26.2
20	6.65	2.68	3.98	14.13	21.5	35.63	7.87	2.32	5.55	⁴⁾	⁵⁾	28.2
24	6.65	2.68	3.98	16.18	23.39	39.57	7.87	2.32	5.55	⁴⁾	⁵⁾	32.3

- 1) Depending on the cable gland used: values up to +1.18 in
- 2) With order code for "Sensor option", option CG "Sensor extended neck for insulation" or order code for "Liner", option B "PFA high temperature": values + 4.33 in
- 3) For version without local display: values - 1.18 in
- 4) Depends on the liner
- 5) Total length is independent of the process connections. Length according to DVGW (German Technical and Scientific Association for Gas and Water). → 66

Order code for "Housing", option A "Aluminum, coated"; Ex d

DN	A ¹⁾	B ¹⁾	C	D	E ²⁾	F ²⁾	G ³⁾	H	I ³⁾	K	L	M
[in]	[in]	[in]	[in]	[in]	[in]	[in]	[in]	[in]	[in]	[in]	[in]	[in]
½	7.4	3.35	4.06	3.31	11.85	15.16	8.54	2.28	5.83	⁴⁾	⁵⁾	4.72
1	7.4	3.35	4.06	3.31	11.85	15.16	8.54	2.28	5.83	⁴⁾	⁵⁾	4.72
1 ¼	7.4	3.35	4.06	3.31	11.85	15.16	8.54	2.28	5.83	⁴⁾	⁵⁾	4.72
1 ½	7.4	3.35	4.06	3.31	11.85	15.16	8.54	2.28	5.83	⁴⁾	⁵⁾	4.72
2	7.4	3.35	4.06	3.31	11.85	15.16	8.54	2.28	5.83	⁴⁾	⁵⁾	4.72
2 ½	7.4	3.35	4.06	4.29	12.83	17.13	8.54	2.28	5.83	⁴⁾	⁵⁾	7.09
3	7.4	3.35	4.06	4.29	12.83	17.13	8.54	2.28	5.83	⁴⁾	⁵⁾	7.09
4	7.4	3.35	4.06	4.29	12.83	17.13	8.54	2.28	5.83	⁴⁾	⁵⁾	7.09
5	7.4	3.35	4.06	5.91	14.41	20.31	8.54	2.28	5.83	⁴⁾	⁵⁾	10.2
6	7.4	3.35	4.06	5.91	14.41	20.31	8.54	2.28	5.83	⁴⁾	⁵⁾	10.2
8	7.4	3.35	4.06	7.09	15.39	22.48	8.54	2.28	5.83	⁴⁾	⁵⁾	12.8
10	7.4	3.35	4.06	8.07	16.38	24.45	8.54	2.28	5.83	⁴⁾	⁵⁾	15.8
12	7.4	3.35	4.06	9.06	17.36	26.42	8.54	2.28	5.83	⁴⁾	⁵⁾	18.1
14	7.4	3.35	4.06	11.1	19.65	30.75	8.54	2.28	5.83	⁴⁾	⁵⁾	22.2
16	7.4	3.35	4.06	12.13	20.71	32.83	8.54	2.28	5.83	⁴⁾	⁵⁾	24.3
18	7.4	3.35	4.06	13.11	21.69	34.8	8.54	2.28	5.83	⁴⁾	⁵⁾	26.2
20	7.4	3.35	4.06	14.13	22.68	36.81	8.54	2.28	5.83	⁴⁾	⁵⁾	28.2
24	7.4	3.35	4.06	16.18	24.57	40.75	8.54	2.28	5.83	⁴⁾	⁵⁾	32.3

- 1) Depending on the cable gland used: values up to +1.18 in
- 2) With order code for "Sensor option", option CG "Sensor extended neck for insulation" or order code for "Liner", option B "PFA high temperature": values + 4.33 in
- 3) For version without local display: values - 1.93 in
- 4) Depends on the liner
- 5) Total length is independent of the process connections. Length according to DVGW (German Technical and Scientific Association for Gas and Water). → 66

Flange connections

Flange

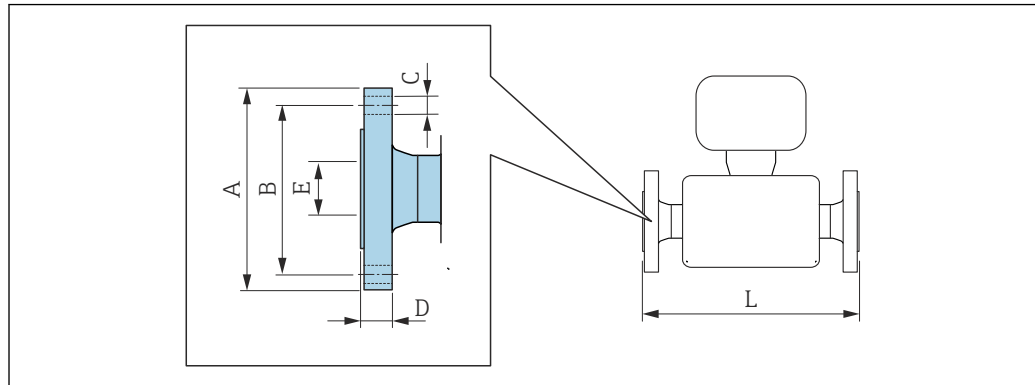

A0015621

Flange according to ASME B16.5, Class 150

A 105: order code for "Process connection", option A1K

1.4404 (F316/F316L): order code for "Process connection", option A1S

DN [in]	A [in]	B [in]	C [in]	D [in]	E [in]	L ¹⁾ [in]
½	3.5	2.38	4 × Ø0.63	0.38	0.88	7.87
1	4.25	3.12	4 × Ø0.63	0.5	1.35	7.87
1 ½	5	3.88	4 × Ø0.63	0.63	1.93	7.87
2	6	4.75	4 × Ø0.75	0.69	2.41	7.87
3	7.5	6	4 × Ø0.75	0.88	3.54	7.87
4	9	7.5	8 × Ø0.75	0.88	4.54	9.84
6	11	9.5	8 × Ø0.88	0.94	6.7	11.8
8	13.5	11.75	8 × Ø0.88	1.06	8.7	13.8
10	16	14.25	12 × Ø1	1.17	10.85	17.7
12	19	17	12 × Ø1	1.19	12.85	19.7
14	21.06	18.75	12 × Ø1.13	1.39	13.62	21.7
16	23.43	21.25	16 × Ø1.13	1.46	15.59	23.6
18	25	22.75	16 × Ø1.25	1.58	17.6	25.6
20	27.56	25	20 × Ø1.25	1.7	19.61	25.6
24	32.09	29.5	20 × Ø1.37	1.89	23.62	30.7

Surface roughness (flange): Ra 6.3 to 12.5 µm

1) Length according to DVGW (German Technical and Scientific Association for Gas and Water).

Flange according to ASME B16.5, Class 300

A 105: order code for "Process connection", option A2K

1.4404 (F316/F316L): order code for "Process connection", option A2S

DN [in]	A [in]	B [in]	C [in]	D [in]	E [in]	L ¹⁾ [in]
½	3.75	2.62	4 × Ø0.63	0.5	0.88	7.87
1	4.88	3.5	4 × Ø0.75	0.63	1.35	7.87
1 ½	6.12	4.5	4 × Ø0.88	0.75	1.93	7.87
2	6.5	5	8 × Ø0.75	0.82	2.41	7.87

Flange according to ASME B16.5, Class 300
A 105: order code for "Process connection", option A2K
1.4404 (F316/F316L): order code for "Process connection", option A2S

DN [in]	A [in]	B [in]	C [in]	D [in]	E [in]	L ¹⁾ [in]
3	8.25	6.62	8 × Ø0.88	1.06	3.54	7.87
4	10	7.88	8 × Ø0.88	1.19	4.54	9.84
6	12.5	10.62	12 × Ø0.88	1.38	6.7	11.8

Surface roughness (flange): Ra 6.3 to 12.5 µm

1) Length according to DVGW (German Technical and Scientific Association for Gas and Water).

Accessories

Protective cover

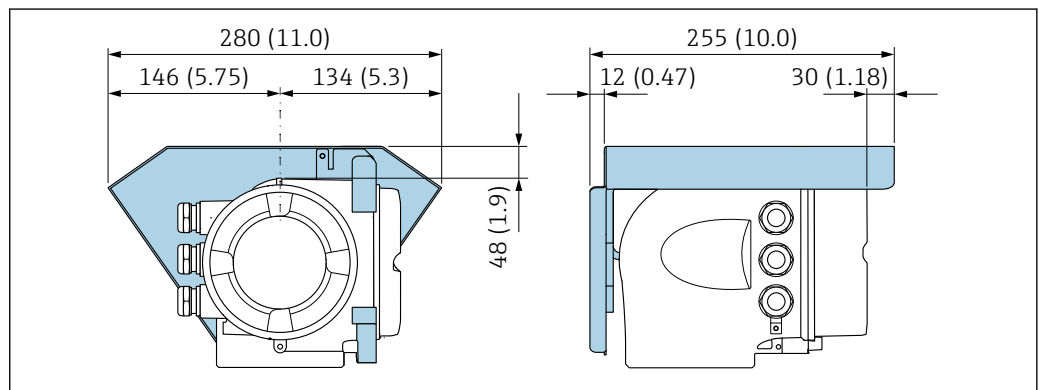

A0029553

Remote display and operating module DKX001

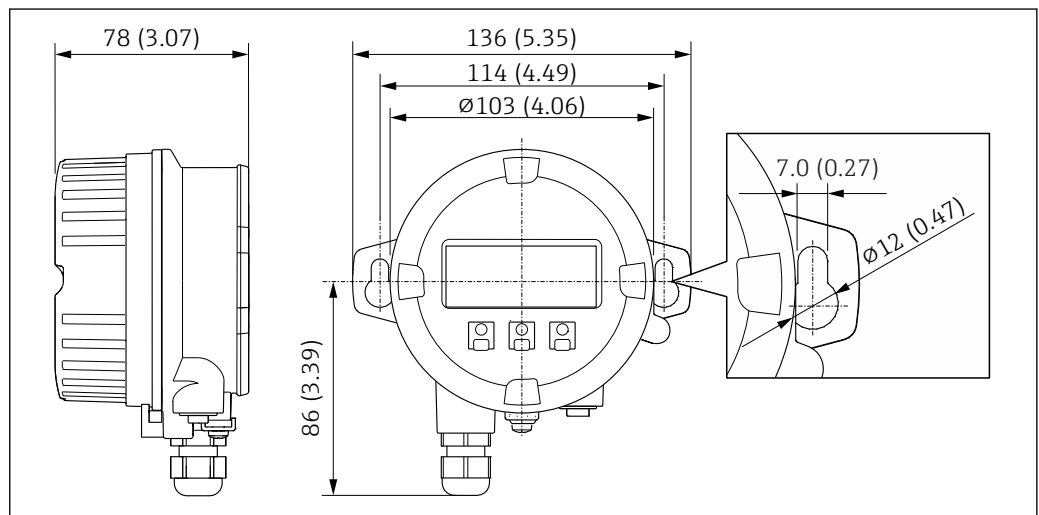

A0028921

39 Engineering unit mm (in)

External WLAN antenna

i The external WLAN antenna is not suitable for use in hygienic applications.

External WLAN antenna mounted on device

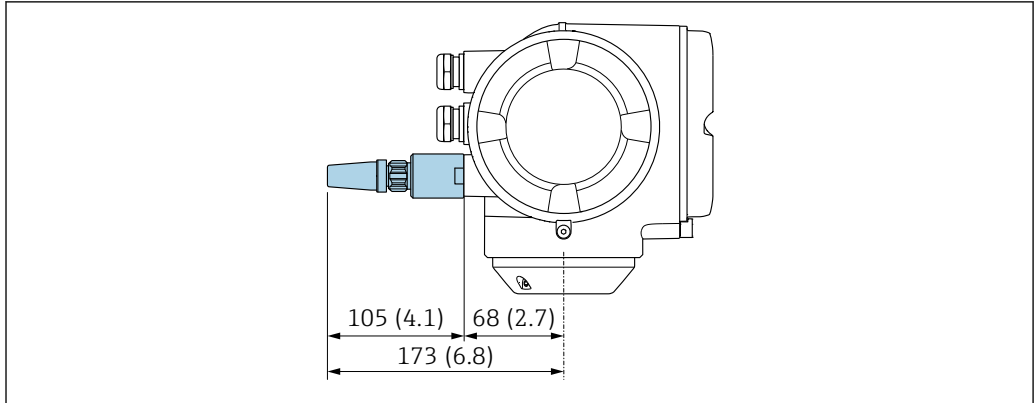

A0028923

40 Engineering unit mm (in)

External WLAN antenna mounted with cable

The external WLAN antenna can be mounted separately from the transmitter if the transmission/reception conditions at the transmitter mounting location are poor.

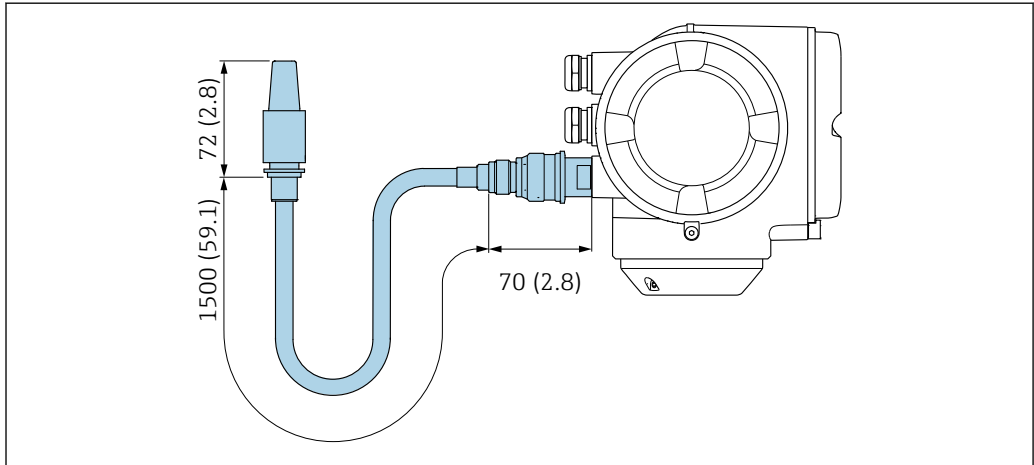

A0033597

41 Engineering unit mm (in)

Ground disk for flange connection

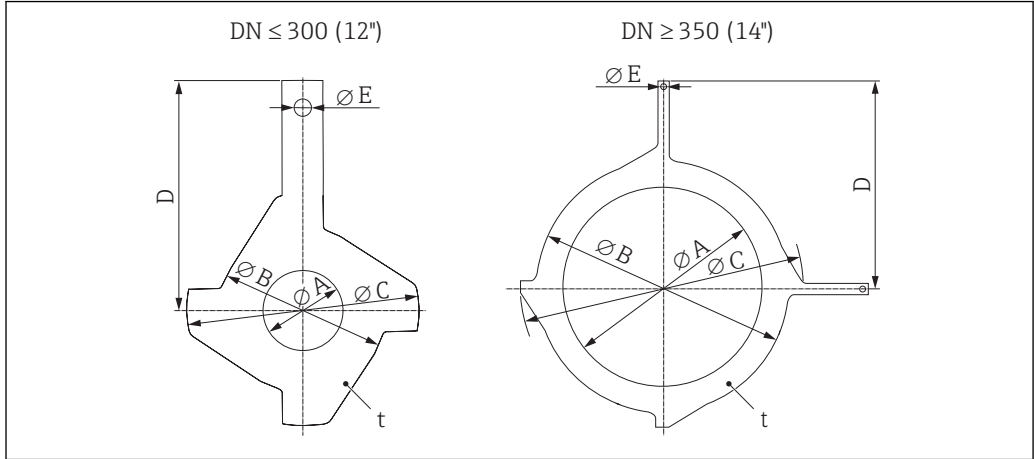

A0003221

DN ¹⁾ ASME [in]	A PFA, PTFE [in]	B [in]	C [in]	D [in]	E [in]	t [in]
½	0.63	1.69	2.42	2.87	0.26	0.08
1	1.02	2.44	3.05	3.44	0.26	0.08
1 ½	1.61	3.23	3.98	4.06	0.26	0.08
2	2.05	3.98	4.55	4.25	0.26	0.08
3	3.15	5.16	6.08	5.31	0.26	0.08
4	4.09	6.14	7.34	6.02	0.26	0.08
6	6.22	8.54	10.08	7.24	0.26	0.08
8	8.11	10.51	11.34	8.07	0.26	0.08
10	10.24	12.91	14.13	9.45	0.26	0.08
12	12.28	14.76	16.26	10.75	0.26	0.08
14	13.50	17.05	18.86	14.37	0.35	0.08
16	15.47	18.90	21.34	15.55	0.35	0.08
18	17.28	21.18	22.95	16.42	0.35	0.08
20	19.41	23.31	25.59	18.11	0.35	0.08
24	23.35	27.28	30.16	20.55	0.35	0.08

1) Ground disks can be used for all available pressure ratings.

Weight

All values (weight exclusive of packaging material) refer to devices for standard pressure ratings. Weight specifications including transmitter as per order code for "Housing", option A "Aluminum, coated".

Different values due to different transmitter versions:

Transmitter version for the hazardous area

(Order code for "Housing", option A "Aluminum, coated"; Ex d): +2 kg (+4.4 lbs)

Weight in SI units

Nominal diameter		EN (DIN), AS ¹⁾		ASME		JIS	
[mm]	[in]	Pressure rating	[kg]	Pressure rating	[kg]	Pressure rating	[kg]
15	½	PN 40	7.2	Class 150	7.2	10K	4.5
25	1	PN 40	8.0	Class 150	8.0	10K	5.3
32	-	PN 40	8.7	Class 150	-	10K	5.3
40	1 ½	PN 40	10.1	Class 150	10.1	10K	6.3
50	2	PN 40	11.3	Class 150	11.3	10K	7.3
65	-	PN 16	12.7	Class 150	-	10K	9.1
80	3	PN 16	14.7	Class 150	14.7	10K	10.5
100	4	PN 16	16.7	Class 150	16.7	10K	12.7
125	-	PN 16	22.2	Class 150	-	10K	19
150	6	PN 16	26.2	Class 150	26.2	10K	22.5
200	8	PN 10	45.7	Class 150	45.7	10K	39.9
250	10	PN 10	65.7	Class 150	75.7	10K	67.4
300	12	PN 10	70.7	Class 150	111	10K	70.3
350	14	PN 10	105.7	Class 150	176	10K	79
400	16	PN 10	120.7	Class 150	206	10K	100

Nominal diameter		EN (DIN), AS ¹⁾		ASME		JIS	
[mm]	[in]	Pressure rating	[kg]	Pressure rating	[kg]	Pressure rating	[kg]
450	18	PN 10	161.7	Class 150	256	10K	128
500	20	PN 10	156.7	Class 150	286	10K	142
600	24	PN 10	208.7	Class 150	406	10K	188

1) For flanges to AS, only DN 25 and 50 are available.

Weight in US units

Nominal diameter		ASME	
[mm]	[in]	Pressure rating	[lbs]
15	½	Class 150	15.9
25	1	Class 150	17.6
40	1 ½	Class 150	22.3
50	2	Class 150	24.9
80	3	Class 150	32.4
100	4	Class 150	36.8
150	6	Class 150	57.7
200	8	Class 150	101
250	10	Class 150	167
300	12	Class 150	244
350	14	Class 150	387
400	16	Class 150	454
450	18	Class 150	564
500	20	Class 150	630
600	24	Class 150	895

Measuring tube specification

Nominal diameter		Pressure rating					Process connection internal diameter			
		EN (DIN)	ASME	AS 2129	AS 4087	JIS	PFA		PTFE	
[mm]	[in]	[bar]	[psi]	[bar]	[bar]	[bar]	[mm]	[in]	[mm]	[in]
15	½	PN 40	Class 150	-	-	20K	-	-	15	0.59
25	1	PN 40	Class 150	Table E	-	20K	23	0.91	26	1.02
32	-	PN 40	-	-	-	20K	32	1.26	35	1.38
40	1 ½	PN 40	Class 150	-	-	20K	36	1.42	41	1.61
50	2	PN 40	Class 150	Table E	PN 16	10K	48	1.89	52	2.05
65	-	PN 16	-	-	-	10K	63	2.48	67	2.64
80	3	PN 16	Class 150	-	-	10K	75	2.95	80	3.15
100	4	PN 16	Class 150	-	-	10K	101	3.98	104	4.09
125	-	PN 16	-	-	-	10K	126	4.96	129	5.08
150	6	PN 16	Class 150	-	-	10K	154	6.06	156	6.14
200	8	PN 10	Class 150	-	-	10K	201	7.91	202	7.95
250	10	PN 10	Class 150	-	-	10K	-	-	256	10.1
300	12	PN 10	Class 150	-	-	10K	-	-	306	12.0

Nominal diameter		Pressure rating					Process connection internal diameter			
		EN (DIN)	ASME	AS 2129	AS 4087	JIS	PFA		PTFE	
[mm]	[in]	[bar]	[psi]	[bar]	[bar]	[bar]	[mm]	[in]	[mm]	[in]
350	14	PN 10	Class 150	-	-	10K	-	-	337	13.3
400	16	PN 10	Class 150	-	-	10K	-	-	387	15.2
450	18	PN 10	Class 150	-	-	10K	-	-	432	17.0
500	20	PN 10	Class 150	-	-	10K	-	-	487	19.2
600	24	PN 10	Class 150	-	-	10K	-	-	593	23.3

Materials

Transmitter housing

Order code for "Housing":

Option **A** "Aluminum, coated": aluminum, AlSi10Mg, coated

Window material

Order code for "Housing":

Option **A** "Aluminum, coated": glass

Cable entries/cable glands

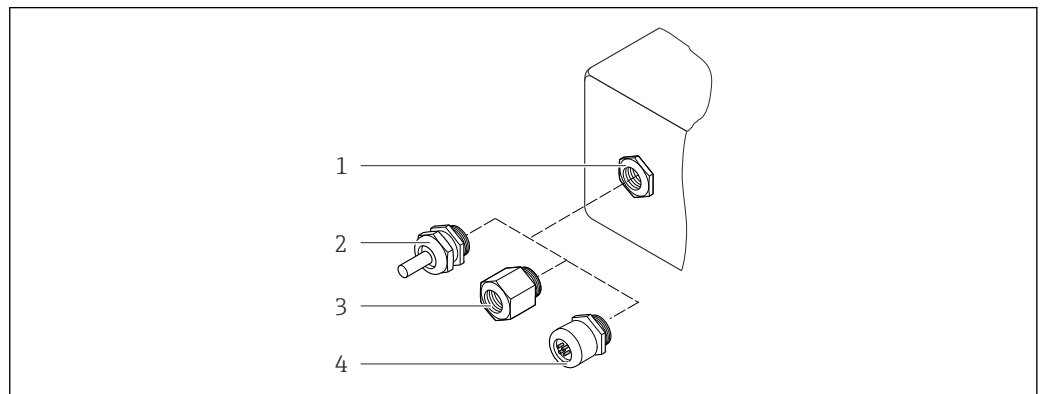

42 Possible cable entries/cable glands

- 1 Female thread M20 × 1.5
- 2 Cable gland M20 × 1.5
- 3 Adapter for cable entry with internal thread G ½"
- 4 Device plugs

Order code for "Housing", option A "Aluminum, coated"

The various cable entries are suitable for hazardous and non-hazardous areas.

Cable entry/cable gland	Material
Cable gland M20 × 1.5	Plastic/nickel-plated brass
Adapter for cable entry with internal thread G ½"	Nickel-plated brass
Adapter for cable entry with internal thread NPT ½"	

Device plug

Electrical connection	Material
Plug M12x1	<ul style="list-style-type: none"> ▪ Socket: Stainless steel, 1.4404 (316L) ▪ Contact housing: Polyamide ▪ Contacts: Gold-plated brass

Sensor housing

- DN 15 to 300 (½ to 12"): coated aluminum AlSi10Mg
- DN 350 to 600 (14 to 24"): carbon steel with protective varnish

Measuring tubes

Stainless steel, 1.4301/304/1.4306/304L

For flanges made of carbon with Al/Zn protective coating (DN 15 to 300 (½ to 12")) or protective varnish (DN 350 to 600 (14 to 24"))

Liner

- PFA
- PTFE

Process connections

EN 1092-1 (DIN 2501)

Stainless steel, 1.4571 (F316L); carbon steel, E250C ¹⁾/S235JRG2/P245GH

ASME B16.5

Stainless steel, F316L; carbon steel, A105 ¹⁾

JIS B2220

Stainless steel, 1.0425 (F316L) ¹⁾; carbon steel, A105/A350 LF2

AS 2129 Table E

- DN 25 (1"): carbon steel, A105/S235JRG2
- DN 40 (1 ½"): carbon steel, A105/S275JR

AS 4087 PN 16

Carbon steel, A105/S275JR

Electrodes

Stainless steel, 1.4435 (F316L); Alloy C22, 2.4602 (UNS N06022); platinum; tantalum; titanium

Seals

As per DIN EN 1514-1, form IBC

Accessories*Protective cover*

Stainless steel, 1.4404 (316L)

External WLAN antenna

- Antenna: ASA plastic (acrylic ester-styrene-acrylonitrile) and nickel-plated brass
- Adapter: Stainless steel and nickel-plated brass
- Cable: Polyethylene
- Plug: Nickel-plated brass
- Angle bracket: Stainless steel

Ground disks

Stainless steel, 1.4435 (F316L); Alloy C22, 2.4602 (UNS N06022); tantalum; titanium

Fitted electrodes

Measuring electrodes, reference electrodes and electrodes for empty pipe detection:

- Standard: stainless steel, 1.4435 (F316L); Alloy C22, 2.4602 (UNS N06022); tantalum, titanium
- Optional: only platinum measuring electrodes

1) DN 15 to 300 (½ to 12") with Al/Zn protective coating; DN 350 to 600 (14 to 24") with protective varnish

Process connections

- EN 1092-1 (DIN 2501)
- ASME B16.5
- JIS B2220
- AS 2129 Table E
- AS 4087 PN 16

 For information on the different materials used in the process connections →  72

Surface roughness

Stainless steel electrodes, 1.4435 (F316L); Alloy C22, 2.4602 (UNS N06022); platinum; tantalum; titanium:
 ≤ 0.3 to 0.5 µm (11.8 to 19.7 µin)
 (All data relate to parts in contact with fluid)

Liner with PFA:
 ≤ 0.4 µm (15.7 µin)
 (All data relate to parts in contact with fluid)

Operability

Operating concept

Operator-oriented menu structure for user-specific tasks

- Commissioning
- Operation
- Diagnostics
- Expert level

Fast and safe commissioning

- Guided menus ("Make-it-run" wizards) for applications
- Menu guidance with brief descriptions of the individual parameter functions
- Device access via Web server or SmartBlue app →  91
- WLAN access to the device via mobile handheld terminal, tablet or smart phone

Reliable operation

- Operation in local language →  73
- Uniform operating philosophy applied to device and operating tools
- If replacing electronic modules, transfer the device configuration via the integrated memory (HistoROM backup) which contains the process and measuring device data and the event logbook. No need to reconfigure.

Efficient diagnostics increase measurement availability

- Troubleshooting measures can be called up via the device and in the operating tools
- Diverse simulation options, logbook for events that occur and optional line recorder functions

Languages

Can be operated in the following languages:

- Via local operation
 English, German, French, Spanish, Italian, Dutch, Portuguese, Polish, Russian, Turkish, Chinese, Japanese, Korean, Bahasa (Indonesian), Vietnamese, Czech, Swedish
- Via Web browser
 English, German, French, Spanish, Italian, Dutch, Portuguese, Polish, Russian, Turkish, Chinese, Japanese, Korean, Bahasa (Indonesian), Vietnamese, Czech, Swedish
- Via "FieldCare", "DeviceCare" operating tool: English, German, French, Spanish, Italian, Chinese, Japanese

Local operation

Via display module

Two display modules are available:

- Order code for "Display; operation", option F "4-line, illuminated, graphic display; touch control"
- Order code for "Display; operation", option G "4-line, illuminated, graphic display; touch control + WLAN"

 Information about WLAN interface →  80

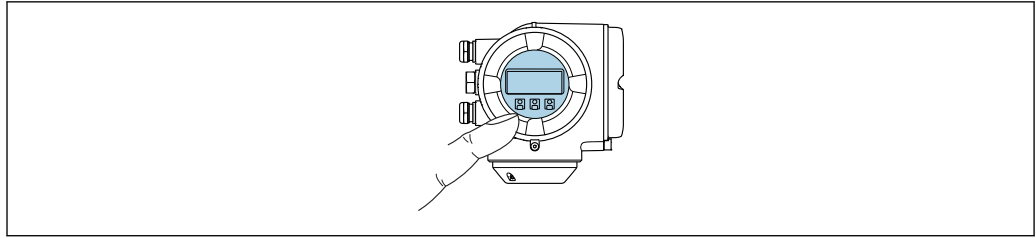

A0026785

43 Operation with touch control

Display elements

- 4-line, illuminated, graphic display
- White background lighting; switches to red in event of device errors
- Format for displaying measured variables and status variables can be individually configured
- Permitted ambient temperature for the display: -20 to $+60$ °C (-4 to $+140$ °F)
The readability of the display may be impaired at temperatures outside the temperature range.

Operating elements

- External operation via touch control (3 optical keys) without opening the housing: ⊕, ⊖, ⊞
- Operating elements also accessible in the various zones of the hazardous area

Via remote display and operating module DKX001

 The remote display and operating module DKX001 is available as an optional extra → 89.

- The measuring device is always supplied with a dummy cover when the remote display and operating module DKX001 is ordered directly with the measuring device. Display or operation at the transmitter is not possible in this case.
- If ordered subsequently, the remote display and operating module DKX001 may not be connected at the same time as the existing measuring device display module. Only one display or operation unit may be connected to the transmitter at any one time.

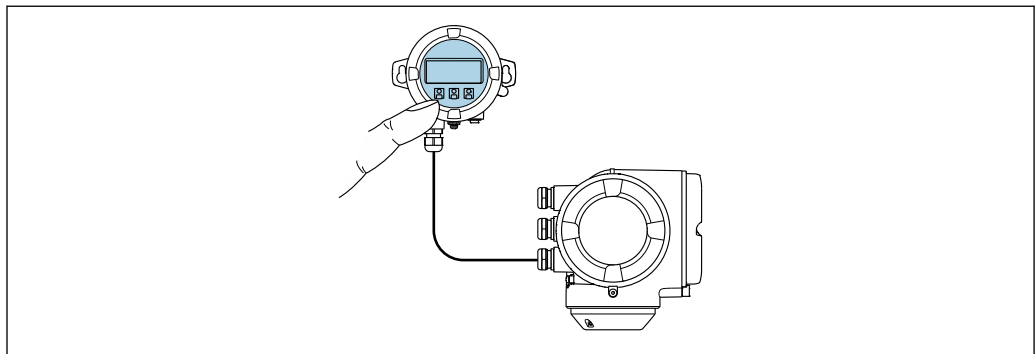

A0026786

44 Operation via remote display and operating module DKX001

Display and operating elements

The display and operating elements correspond to those of the display module → 73.

Material

The housing material of the display and operating module DKX001 depends on the choice of transmitter housing material.

Transmitter housing		Remote display and operating module
Order code for "Housing"	Material	Material
Option A "Aluminum, coated"	AlSi10Mg, coated	AlSi10Mg, coated

Cable entry

Corresponds to the choice of transmitter housing, order code for "Electrical connection".

Connecting cable

→  43

Dimensions

→  62

Remote operation

Via HART protocol

This communication interface is available in device versions with a HART output.

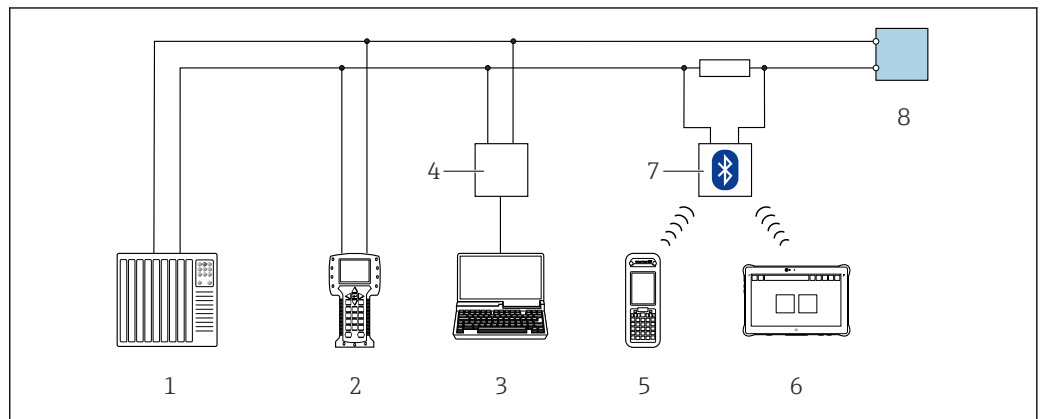

A0028747

 45 *Options for remote operation via HART protocol (active)*

- 1 *Control system (e.g. PLC)*
- 2 *Field Communicator 475*
- 3 *Computer with Web browser (e.g. Internet Explorer) for access to the integrated device Web server or computer with an operating tool (e.g. FieldCare, DeviceCare, AMS Device Manager, SIMATIC PDM) with COM DTM "CDI Communication TCP/IP"*
- 4 *Commubox FXA195 (USB)*
- 5 *Field Xpert SFX350 or SFX370*
- 6 *Field Xpert SMT70*
- 7 *VIATOR Bluetooth modem with connecting cable*
- 8 *Transmitter*

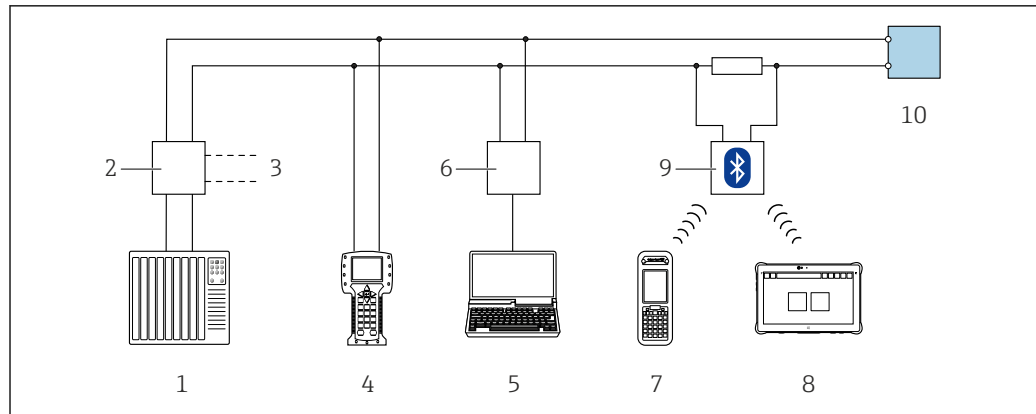

A0028746

46 Options for remote operation via HART protocol (passive)

- 1 Control system (e.g. PLC)
- 2 Transmitter power supply unit, e.g. RN221N (with communication resistor)
- 3 Connection for Commubox FXA195 and Field Communicator 475
- 4 Field Communicator 475
- 5 Computer with Web browser (e.g. Internet Explorer) for access to the integrated device Web server or computer with an operating tool (e.g. FieldCare, DeviceCare, AMS Device Manager, SIMATIC PDM) with COM DTM "CDI Communication TCP/IP"
- 6 Commubox FXA195 (USB)
- 7 Field Xpert SFX350 or SFX370
- 8 Field Xpert SMT70
- 9 VIATOR Bluetooth modem with connecting cable
- 10 Transmitter

Via FOUNDATION Fieldbus network

This communication interface is available in device versions with FOUNDATION Fieldbus.

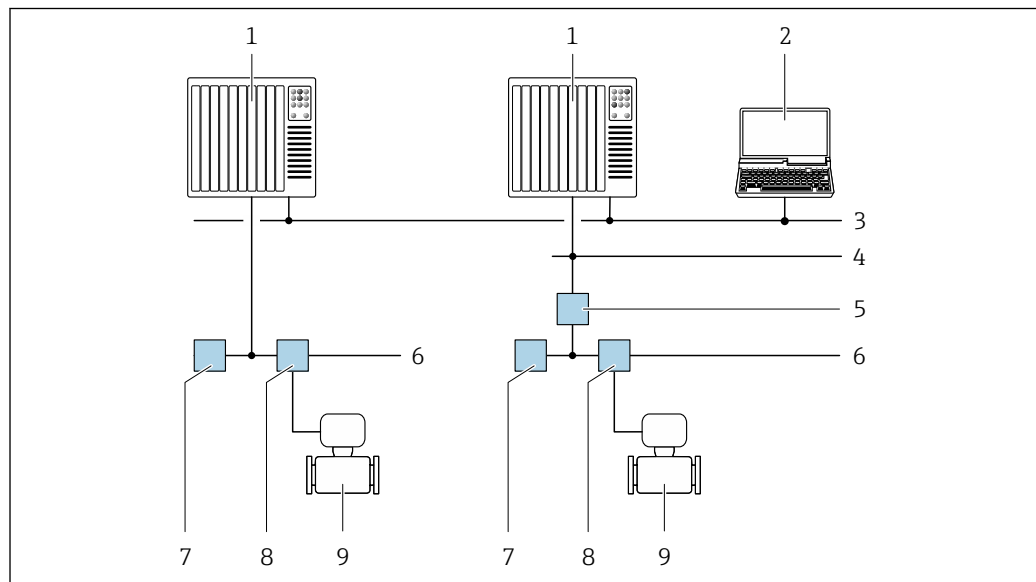

A0028837

47 Options for remote operation via FOUNDATION Fieldbus network

- 1 Automation system
- 2 Computer with FOUNDATION Fieldbus network card
- 3 Industry network
- 4 High Speed Ethernet FF-HSE network
- 5 Segment coupler FF-HSE/FF-H1
- 6 FOUNDATION Fieldbus FF-H1 network
- 7 Power supply FF-H1 network
- 8 T-box
- 9 Measuring device

Via PROFIBUS DP network

This communication interface is available in device versions with PROFIBUS DP.

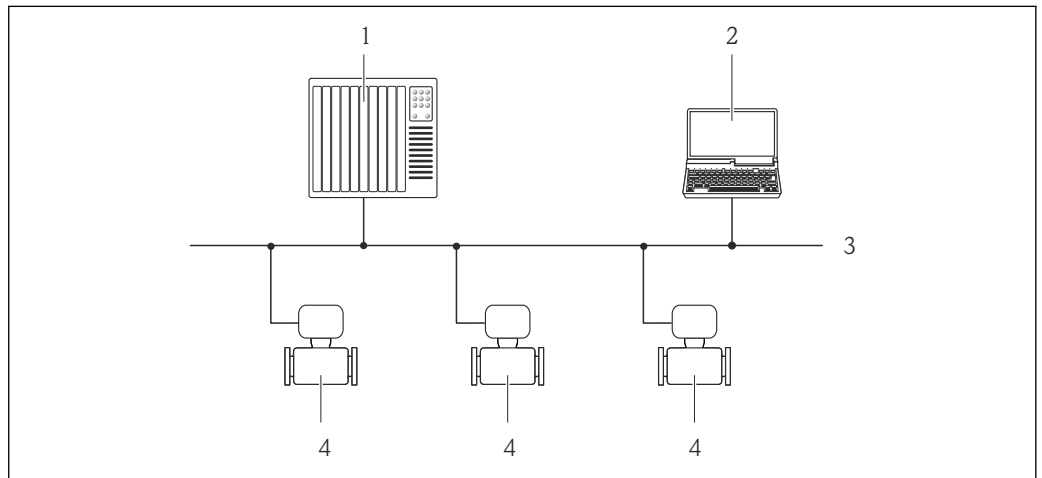

A0020903

48 Options for remote operation via PROFIBUS DP network

- 1 Automation system
- 2 Computer with PROFIBUS network card
- 3 PROFIBUS DP network
- 4 Measuring device

Via PROFIBUS PA network

This communication interface is available in device versions with PROFIBUS PA.

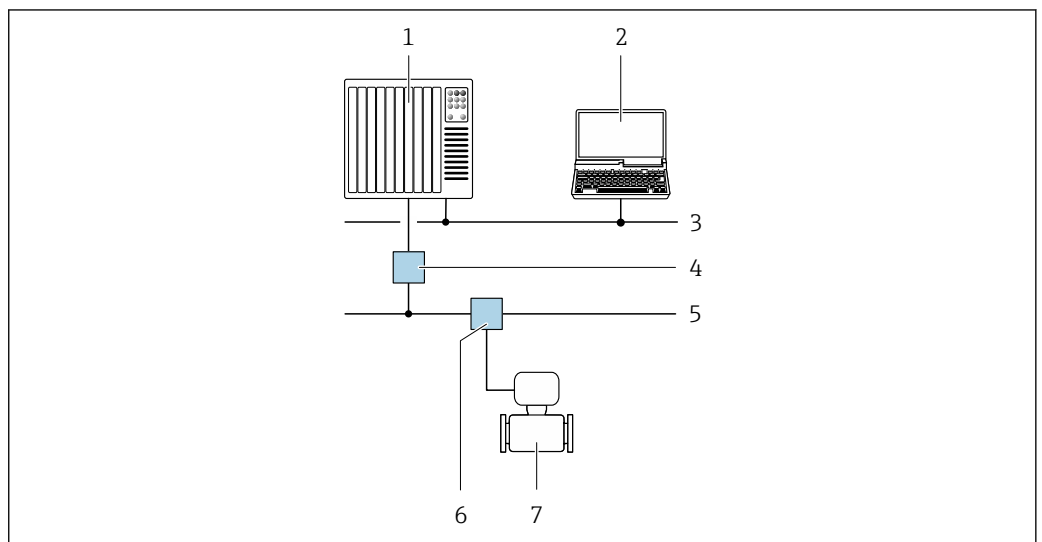

A0028838

49 Options for remote operation via PROFIBUS PA network

- 1 Automation system
- 2 Computer with PROFIBUS network card
- 3 PROFIBUS DP network
- 4 Segment coupler PROFIBUS DP/PA
- 5 PROFIBUS PA network
- 6 T-box
- 7 Measuring device

Via Modbus RS485 protocol

This communication interface is available in device versions with a Modbus-RS485 output.

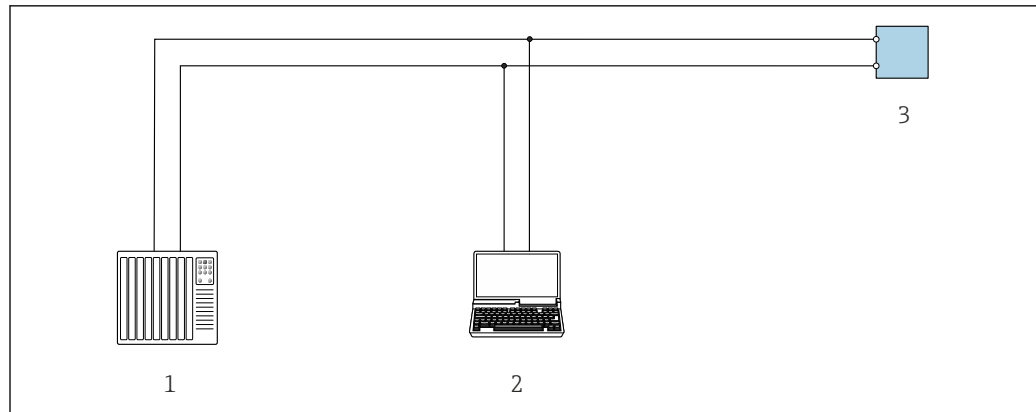

A0029437

50 Options for remote operation via Modbus-RS485 protocol (active)

- 1 Control system (e.g. PLC)
- 2 Computer with Web browser (e.g. Internet Explorer) for accessing the integrated device Web server or with operating tool (e.g. FieldCare, DeviceCare) with COM DTM "CDI Communication TCP/IP" or Modbus DTM
- 3 Transmitter

Via EtherNet/IP network

This communication interface is available in device versions with EtherNet/IP.

Star topology

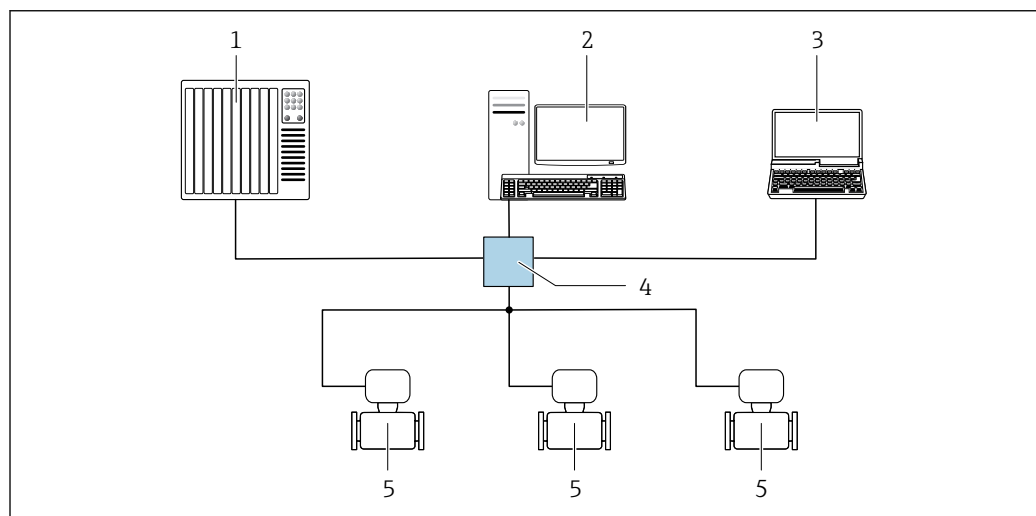

A0032078

51 Options for remote operation via EtherNet/IP network: star topology

- 1 Automation system, e.g. "RSLogix" (Rockwell Automation)
- 2 Workstation for measuring device operation: with Custom Add-On Profile for "RSLogix 5000" (Rockwell Automation) or with Electronic Data Sheet (EDS)
- 3 Computer with Web browser (e.g. Internet Explorer) for accessing the integrated device Web server or computer with operating tool (e.g. FieldCare, DeviceCare) with COM DTM "CDI Communication TCP/IP"
- 4 Ethernet switch
- 5 Measuring device

Ring topology

The device is integrated via the terminal connection for signal transmission (output 1) and the service interface (CDI-RJ45).

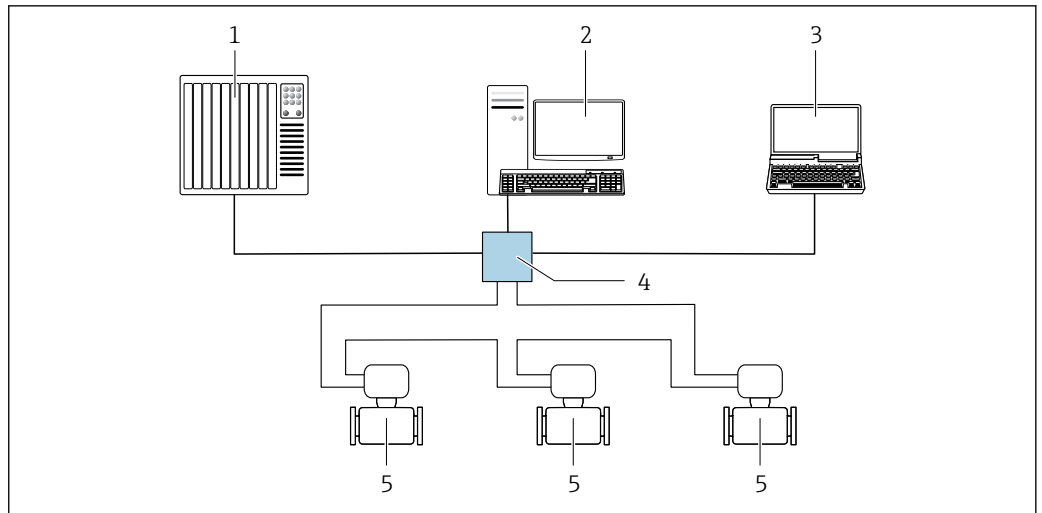

A0033725

52 Options for remote operation via EtherNet/IP network: ring topology

- 1 Automation system, e.g. "RSLogix" (Rockwell Automation)
- 2 Workstation for measuring device operation: with Custom Add-On Profile for "RSLogix 5000" (Rockwell Automation) or with Electronic Data Sheet (EDS)
- 3 Computer with Web browser (e.g. Internet Explorer) for accessing the integrated device Web server or computer with operating tool (e.g. FieldCare, DeviceCare) with COM DTM "CDI Communication TCP/IP"
- 4 Ethernet switch
- 5 Measuring device

Via PROFINET network

This communication interface is available in device versions with PROFINET.

Star topology

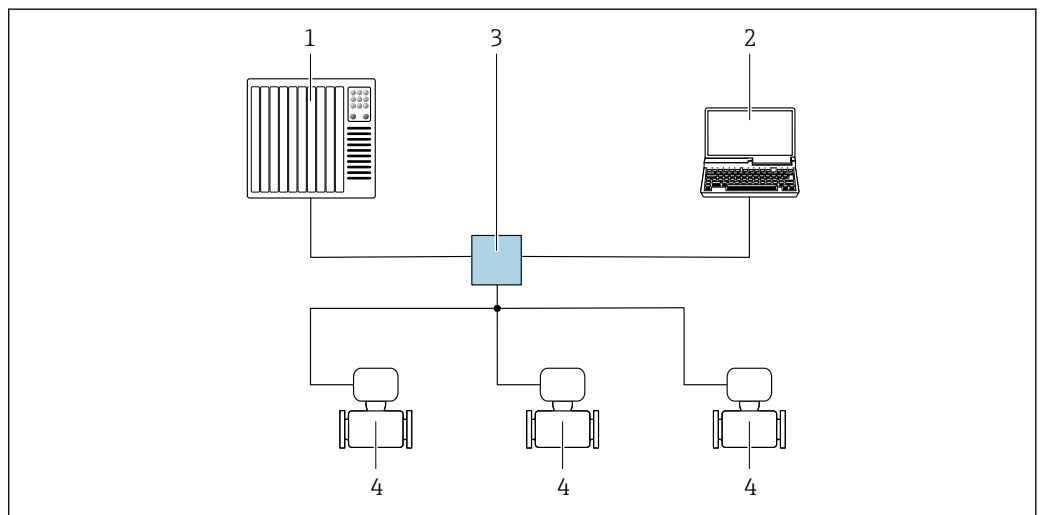

A0026545

53 Options for remote operation via PROFINET network: star topology

- 1 Automation system, e.g. Simatic S7 (Siemens)
- 2 Computer with Web browser (e.g. Internet Explorer) for accessing the integrated device Web server or computer with operating tool (e.g. FieldCare, DeviceCare, SIMATIC PDM) with COM DTM "CDI Communication TCP/IP"
- 3 Switch, e.g. Scalance X204 (Siemens)
- 4 Measuring device

Ring topology

This communication interface is available in device versions with PROFINET.

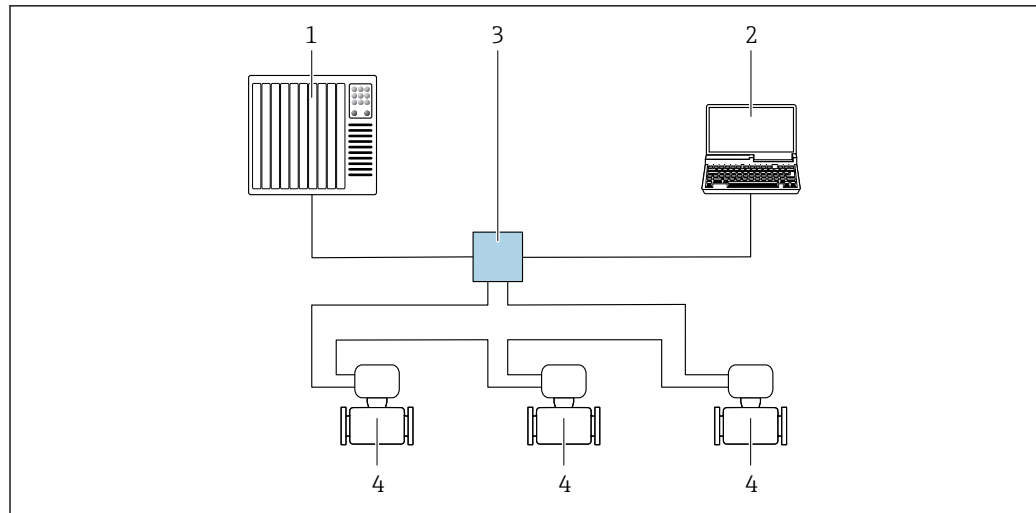

A0033719

54 Options for remote operation via PROFINET network: ring topology

- 1 Automation system, e.g. Simatic S7 (Siemens)
- 2 Computer with Web browser (e.g. Internet Explorer) for accessing the integrated device Web server or computer with operating tool (e.g. FieldCare, DeviceCare, SIMATIC PDM) with COM DTM "CDI Communication TCP/IP"
- 3 Switch, e.g. Scalance X204 (Siemens)
- 4 Measuring device

Service interface

Via service interface (CDI-RJ45)

A point-to-point connection can be established to configure the device onsite. With the housing open, the connection is established directly via the service interface (CDI-RJ45) of the device.

 An adapter for RJ45 and the M12 connector is optionally available:
Order code for "Accessories", option **NB**: "Adapter RJ45 M12 (service interface)"

The adapter connects the service interface (CDI-RJ45) to an M12 connector mounted in the cable entry. Therefore the connection to the service interface can be established via an M12 connector without opening the device.

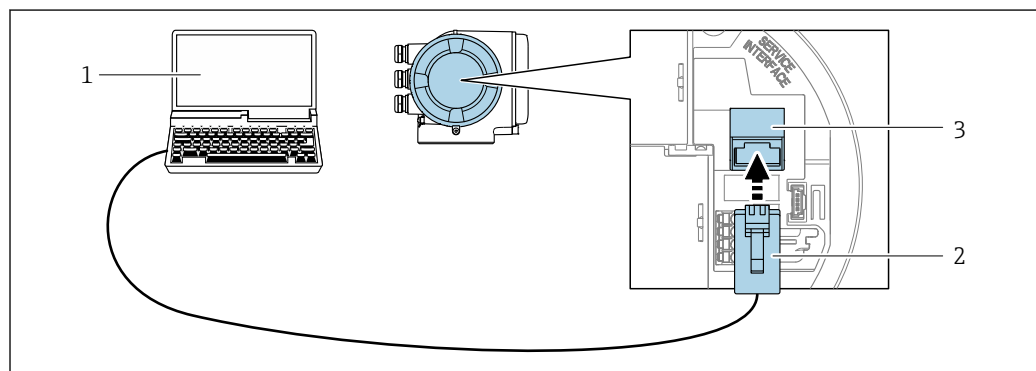

A0027563

55 Connection via service interface (CDI-RJ45)

- 1 Computer with Web browser (e.g. Microsoft Internet Explorer, Microsoft Edge) for accessing the integrated device Web server or with "FieldCare", "DeviceCare" operating tool with COM DTM "CDI Communication TCP/IP" or Modbus DTM
- 2 Standard Ethernet connecting cable with RJ45 connector
- 3 Service interface (CDI-RJ45) of the measuring device with access to the integrated Web server

Via WLAN interface

The optional WLAN interface is available on the following device version:

Order code for "Display; operation", option **G** "4-line, illuminated, graphic display; touch control + WLAN"

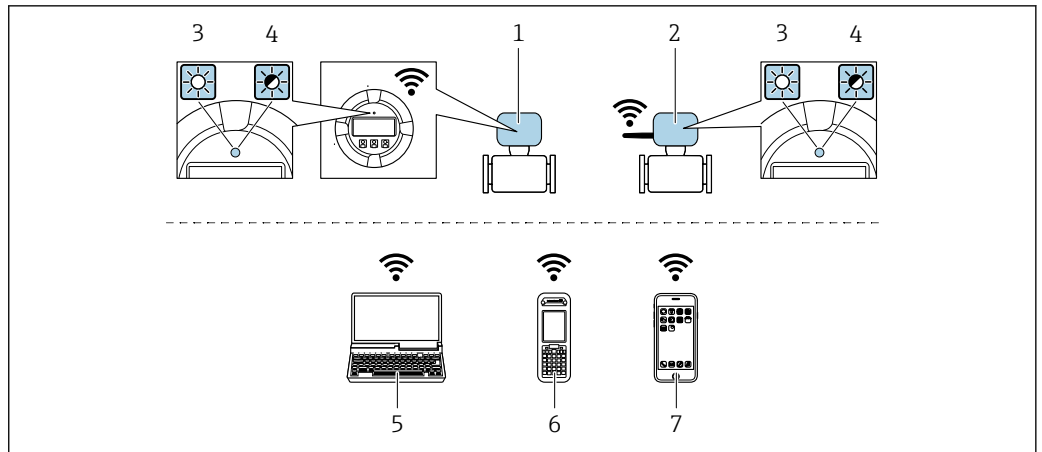

A0034570

- 1 Transmitter with integrated WLAN antenna
- 2 Transmitter with external WLAN antenna
- 3 LED lit constantly: WLAN reception is enabled on measuring device
- 4 LED flashing: WLAN connection established between operating unit and measuring device
- 5 Computer with WLAN interface and Web browser (e.g. Microsoft Internet Explorer, Microsoft Edge) for accessing the integrated device Web server or with operating tool (e.g. FieldCare, DeviceCare)
- 6 Mobile handheld terminal with WLAN interface and Web browser (e.g. Microsoft Internet Explorer, Microsoft Edge) for accessing the integrated device Web server or operating tool (e.g. FieldCare, DeviceCare)
- 7 Smart phone or tablet (e.g. Field Xpert SMT70)

Function	WLAN: IEEE 802.11 b/g (2.4 GHz) <ul style="list-style-type: none"> ▪ Access point with DHCP server (default setting) ▪ Network
Encryption	WPA2-PSK AES-128 (in accordance with IEEE 802.11i)
Configurable WLAN channels	1 to 11
Degree of protection	IP67
Available antennas	<ul style="list-style-type: none"> ▪ Internal antenna ▪ External antenna (optional) <p>In the event of poor transmission/reception conditions at the place of installation. Available as an accessory → 89.</p> <p> Only one antenna active in each case!</p>
Max. range	50 m (164 ft)
Materials: External WLAN antenna	<ul style="list-style-type: none"> ▪ Antenna: ASA plastic (acrylic ester-styrene-acrylonitrile) and nickel-plated brass ▪ Adapter: Stainless steel and nickel-plated brass ▪ Cable: Polyethylene ▪ Connector: Nickel-plated brass ▪ Angle bracket: Stainless steel

Network integration

With the optional OPC-UA-Server application package, the device can be integrated into an Ethernet network via the service interface (CDI-RJ45 and WLAN) and communicate with OPC-UA clients. If the device is used in this way, IT security must be considered.

For permanent access to device data and for device configuration via the Web server, the device is incorporated directly in a network via the service interface (CDI-RJ45). In this way, the device can be accessed any time from the control station. The measured values are processed separately via the inputs and outputs through the automation system.

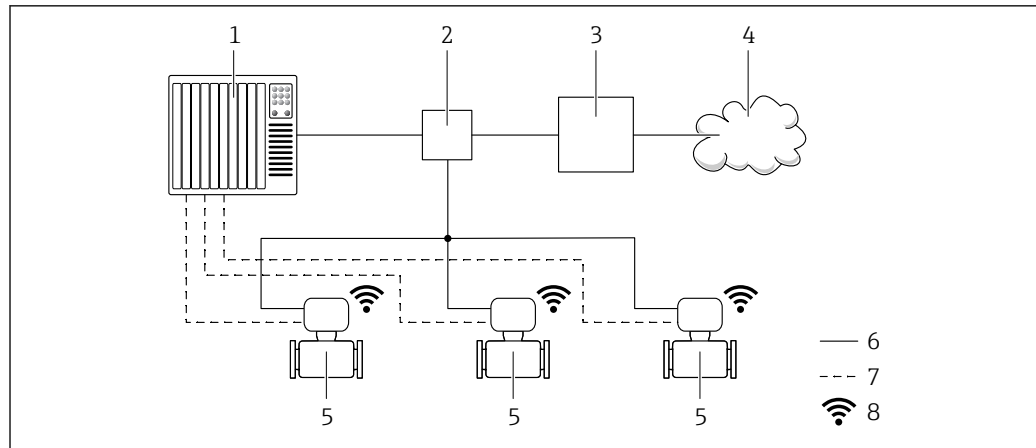

A0033618

- 1 Automation system, e.g. Simatic S7 (Siemens)
- 2 Ethernet switch
- 3 Edge Gateway
- 4 Cloud
- 5 Measuring device
- 6 Ethernet network
- 7 Measured values via inputs and outputs
- 8 Optional WLAN interface



The optional WLAN interface is available on the following device version:

Order code for "Display; operation", option **G** "4-line, illuminated, graphic display; touch control + WLAN"





Special Documentation for the OPC-UA-Server application package → 93.

Supported operating tools

Different operating tools can be used for local or remote access to the measuring device. Depending on the operating tool used, access is possible with different operating units and via a variety of interfaces.

Supported operating tools	Operating unit	Interface	Additional information
Web browser	Notebook, PC or tablet with Web browser	<ul style="list-style-type: none"> ▪ CDI-RJ45 service interface ▪ WLAN interface ▪ Ethernet-based fieldbus (EtherNet/IP, PROFINET) 	Special Documentation for device
DeviceCare SFE100	Notebook, PC or tablet with Microsoft Windows system	<ul style="list-style-type: none"> ▪ CDI-RJ45 service interface ▪ WLAN interface ▪ Fieldbus protocol 	→ 91

Supported operating tools	Operating unit	Interface	Additional information
FieldCare SFE500	Notebook, PC or tablet with Microsoft Windows system	<ul style="list-style-type: none"> ■ CDI-RJ45 service interface ■ WLAN interface ■ Fieldbus protocol 	→  91
Device Xpert	Field Xpert SFX 100/350/370	HART and FOUNDATION Fieldbus fieldbus protocol	Operating Instructions BA01202S Device description files: Use update function of handheld terminal

 Other operating tools based on FDT technology with a device driver such as DTM/iDTM or DD/EDD can be used for device operation. These operating tools are available from the individual manufacturers. Integration into the following operating tools, among others, is supported:

- FactoryTalk AssetCentre (FTAC) by Rockwell Automation → www.rockwellautomation.com
- Process Device Manager (PDM) by Siemens → www.siemens.com
- Asset Management Solutions (AMS) by Emerson → www.emersonprocess.com
- FieldCommunicator 375/475 by Emerson → www.emersonprocess.com
- Field Device Manager (FDM) by Honeywell → www.honeywellprocess.com
- FieldMate by Yokogawa → www.yokogawa.com
- PACTWare → www.pactware.com

The associated device description files are available at: www.endress.com → Downloads

Web server



Thanks to the integrated Web server, the device can be operated and configured via a Web browser and via a service interface (CDI-RJ45) or via a WLAN interface. The structure of the operating menu is the same as for the local display. In addition to the measured values, status information on the device is also displayed and allows the user to monitor the status of the device. Furthermore the device data can be managed and the network parameters can be configured.

A device that has a WLAN interface (can be ordered as an option) is required for the WLAN connection: order code for "Display; operation", option **G** "4-line, illuminated; touch control + WLAN". The device acts as an Access Point and enables communication by computer or a mobile handheld terminal.

Supported functions

Data exchange between the operating unit (such as a notebook for example) and the measuring device:

- Upload the configuration from the measuring device (XML format, configuration backup)
- Save the configuration to the measuring device (XML format, restore configuration)
- Export event list (.csv file)
- Export parameter settings (.csv file or PDF file, document the measuring point configuration)
- Export the Heartbeat verification log (PDF file, only available with the "Heartbeat Verification" application package)
- Flash firmware version for device firmware upgrade, for instance
- Download driver for system integration
- Visualize up to 1000 saved measured values (only available with the **Extended HistoROM** application package →  88)

 Web server special documentation →  93

HistoROM data management

The measuring device features HistoROM data management. HistoROM data management comprises both the storage and import/export of key device and process data, making operation and servicing far more reliable, secure and efficient.

 When the device is delivered, the factory settings of the configuration data are stored as a backup in the device memory. This memory can be overwritten with an updated data record, for example after commissioning.

Additional information on the data storage concept

There are different types of data storage units in which device data are stored and used by the device:

	Device memory	T-DAT	S-DAT
Available data	<ul style="list-style-type: none"> ▪ Event logbook such as diagnostic events for example ▪ Parameter data record backup ▪ Device firmware package ▪ Driver for system integration for exporting via Web server, e.g.: <ul style="list-style-type: none"> – GSD for PROFIBUS DP – GSD for PROFIBUS PA – GSDML for PROFINET – EDS for EtherNet/IP – DD for FOUNDATION Fieldbus 	<ul style="list-style-type: none"> ▪ Measured value logging ("Extended HistoROM" order option) ▪ Current parameter data record (used by firmware at run time) ▪ Peakhold indicator (min/max values) ▪ Totalizer values 	<ul style="list-style-type: none"> ▪ Sensor data: nominal diameter etc. ▪ Serial number ▪ Calibration data ▪ Device configuration (e.g. SW options, fixed I/O or multi I/O)
Storage location	Fixed on the user interface board in the connection compartment	Attachable to the user interface board in the connection compartment	In the sensor plug in the transmitter neck part

Data backup

Automatic

- The most important device data (sensor and transmitter) are automatically saved in the DAT modules
- If the transmitter or measuring device is replaced: once the T-DAT containing the previous device data has been exchanged, the new measuring device is ready for operation again immediately without any errors
- If the sensor is replaced: once the sensor has been replaced, new sensor data are transferred from the S-DAT in the measuring device and the measuring device is ready for operation again immediately without any errors
- If exchanging the electronics module (e.g. I/O electronics module): Once the electronics module has been replaced, the software of the module is compared against the current device firmware. The module software is upgraded or downgraded where necessary. The electronics module is available for use immediately afterwards and no compatibility problems occur.

Manual

Additional parameter data record (complete parameter settings) in the integrated device memory HistoROM backup for:

- Data backup function
Backup and subsequent restoration of a device configuration in the device memory HistoROM backup
- Data comparison function
Comparison of the current device configuration with the device configuration saved in the device memory HistoROM backup

Data transfer

Manual

- Transfer of a device configuration to another device using the export function of the specific operating tool, e.g. with FieldCare, DeviceCare or Web server: to duplicate the configuration or to store in an archive (e.g. for backup purposes)
- Transmission of the drivers for system integration via Web server, e.g.:
 - GSD for PROFIBUS DP
 - GSD for PROFIBUS PA
 - GSDML for PROFINET
 - EDS for EtherNet/IP
 - DD for FOUNDATION Fieldbus

Event list

Automatic

- Chronological display of up to 20 event messages in the events list
- If the **Extended HistoROM** application package (order option) is enabled: up to 100 event messages are displayed in the events list along with a time stamp, plain text description and remedial measures
- The events list can be exported and displayed via a variety of interfaces and operating tools e.g. DeviceCare, FieldCare or Web server

Data logging

Manual

If the **Extended HistoROM** application package (order option) is enabled:

- Record up to 1 000 measured values via 1 to 4 channels
- User configurable recording interval
- Record up to 250 measured values via each of the 4 memory channels
- Export the measured value log via a variety of interfaces and operating tools e.g. FieldCare, DeviceCare or web server

Certificates and approvals

 Currently available certificates and approvals can be called up via the product configurator.

CE mark

The device meets the legal requirements of the applicable EU Directives. These are listed in the corresponding EU Declaration of Conformity along with the standards applied.

Endress+Hauser confirms successful testing of the device by affixing to it the CE mark.

C-Tick symbol

The measuring system meets the EMC requirements of the "Australian Communications and Media Authority (ACMA)".

Ex approval

The measuring device is certified for use in hazardous areas and the relevant safety instructions are provided in the separate "Safety Instructions" (XA) document. Reference is made to this document on the nameplate.

 The separate Ex documentation (XA) containing all the relevant explosion protection data is available from your Endress+Hauser sales center.

ATEX, IECEx

Currently, the following versions for use in hazardous areas are available:

Ex db eb

Category	Type of protection
II2G	Ex db eb ia IIC T6...T1 Gb

Ex tb

Category	Type of protection
II2D	Ex tb IIIC Txxx Db

Ex ec

Category	Type of protection
II3G	Ex ec ic IIC T5...T1 Gc

cCSAus

Currently, the following versions for use in hazardous areas are available:

IS (Ex i) and XP (Ex d)

Class I, II, III Division 1 Groups A-G

NI (Ex nA)

Class I Division 2 Groups A - D



Ex de

Class I, Zone 1 AEx/ Ex de ia IIC T6...T1 Gb

Ex nA

Class I, Zone 2 AEx/Ex nA ic IIC T5...T1 Gc

Ex tb
Zone 21 AEx/ Ex tb IIIC T** °C Db

Pharmaceutical compatibility	<ul style="list-style-type: none"> ▪ FDA ▪ USP Class VI ▪ TSE/BSE Certificate of Suitability
Functional safety	<p>The measuring device can be used for flow monitoring systems (min., max., range) up to SIL 2 (single-channel architecture; order code for "Additional approval", option LA) and SIL 3 (multichannel architecture with homogeneous redundancy) and is independently evaluated and certified by the TÜV in accordance with IEC 61508.</p> <p>The following types of monitoring in safety equipment are possible: Volume flow</p> <p> Functional Safety Manual with information on the SIL device →  92</p>
HART certification	<p>HART interface</p> <p>The measuring device is certified and registered by the FieldComm Group. The measuring system meets all the requirements of the following specifications:</p> <ul style="list-style-type: none"> ▪ Certified according to HART 7 ▪ The device can also be operated with certified devices of other manufacturers (interoperability)
FOUNDATION Fieldbus certification	<p>FOUNDATION Fieldbus interface</p> <p>The measuring device is certified and registered by the FieldComm Group. The measuring system meets all the requirements of the following specifications:</p> <ul style="list-style-type: none"> ▪ Certified in accordance with FOUNDATION Fieldbus H1 ▪ Interoperability Test Kit (ITK), revision version 6.2.0 (certificate available on request) ▪ Physical Layer Conformance Test ▪ The device can also be operated with certified devices of other manufacturers (interoperability)
Certification PROFIBUS	<p>PROFIBUS interface</p> <p>The measuring device is certified and registered by the PNO (PROFIBUS User Organization Organization). The measuring system meets all the requirements of the following specifications:</p> <ul style="list-style-type: none"> ▪ Certified in accordance with PROFIBUS PA Profile 3.02 ▪ The device can also be operated with certified devices of other manufacturers (interoperability)
EtherNet/IP certification	<p>The measuring device is certified and registered by the ODVA (Open Device Vendor Association). The measuring system meets all the requirements of the following specifications:</p> <ul style="list-style-type: none"> ▪ Certified in accordance with the ODVA Conformance Test ▪ EtherNet/IP Performance Test ▪ EtherNet/IP PlugFest compliance ▪ The device can also be operated with certified devices of other manufacturers (interoperability)
Certification PROFINET	<p>PROFINET interface</p> <p>The measuring device is certified and registered by the PNO (PROFIBUS User Organization Organization). The measuring system meets all the requirements of the following specifications:</p> <ul style="list-style-type: none"> ▪ Certified according to: <ul style="list-style-type: none"> – Test specification for PROFINET devices – PROFINET Security Level 2 – Netload Class ▪ The device can also be operated with certified devices of other manufacturers (interoperability)
Radio approval	<p>The measuring device has radio approval.</p> <p> For detailed information on the radio approval, see the Special Documentation</p>
Pressure Equipment Directive	<p>The devices can be ordered with or without a PED approval. If a device with a PED approval is required, this must be explicitly stated in the order. For devices with nominal diameters less than or equal to DN 25 (1"), this is neither possible nor necessary.</p>

- With the identification PED/G1/x (x = category) on the sensor nameplate, Endress+Hauser confirms conformity with the "Essential Safety Requirements" specified in Appendix I of the Pressure Equipment Directive 2014/68/EU.
- Devices bearing this marking (PED) are suitable for the following types of medium: Media in Group 1 and 2 with a vapor pressure greater than, or smaller and equal to 0.5 bar (7.3 psi)
- Devices not bearing this marking (PED) are designed and manufactured according to good engineering practice. They meet the requirements of Article 4 paragraph 3 of the Pressure Equipment Directive 2014/68/EU. The range of application is indicated in tables 6 to 9 in Annex II of the Pressure Equipment Directive 2014/68/EU.

Measuring instrument approval

The measuring device is qualified to OIML R117 and has an OIML Certificate of Conformity (optional).

Additional certification

PWIS-free

PWIS = paint-wetting impairment substances

Order code for "Service":

- Option **HC**: PWIS-free (version A)
- Option **HD**: PWIS-free (version B)
- Option **HE**: PWIS-free (version C)



For more information on PWIS-free certification, see "Test specification" document TS01028D

Other standards and guidelines

- EN 60529
Degrees of protection provided by enclosures (IP code)
- EN 61010-1
Safety requirements for electrical equipment for measurement, control and laboratory use - general requirements
- IEC/EN 61326
Emission in accordance with Class A requirements. Electromagnetic compatibility (EMC requirements).
- NAMUR NE 21
Electromagnetic compatibility (EMC) of industrial process and laboratory control equipment
- NAMUR NE 32
Data retention in the event of a power failure in field and control instruments with microprocessors
- NAMUR NE 43
Standardization of the signal level for the breakdown information of digital transmitters with analog output signal.
- NAMUR NE 53
Software of field devices and signal-processing devices with digital electronics
- NAMUR NE 105
Specifications for integrating fieldbus devices in engineering tools for field devices
- NAMUR NE 107
Self-monitoring and diagnosis of field devices
- NAMUR NE 131
Requirements for field devices for standard applications
- ETSI EN 300 328
Guidelines for 2.4 GHz radio components.
- EN 301489
Electromagnetic compatibility and radio spectrum matters (ERM).

Ordering information

Detailed ordering information is available from the following sources:

- In the Product Configurator on the Endress+Hauser website: www.endress.com -> Click "Corporate" -> Select your country -> Click "Products" -> Select the product using the filters and search field -> Open product page -> The "Configure" button to the right of the product image opens the Product Configurator.
- From your Endress+Hauser Sales Center: www.addresses.endress.com

Product Configurator - the tool for individual product configuration

- Up-to-the-minute configuration data
- Depending on the device: Direct input of measuring point-specific information such as measuring range or operating language
- Automatic verification of exclusion criteria
- Automatic creation of the order code and its breakdown in PDF or Excel output format
- Ability to order directly in the Endress+Hauser Online Shop

Application packages

Many different application packages are available to enhance the functionality of the device. Such packages might be needed to address safety aspects or specific application requirements.

The application packages can be ordered with the device or subsequently from Endress+Hauser. Detailed information on the order code in question is available from your local Endress+Hauser sales center or on the product page of the Endress+Hauser website: www.endress.com.



Diagnostics functions

Package	Description
Extended HistoROM	<p>Comprises extended functions concerning the event log and the activation of the measured value memory.</p> <p>Event log: Memory volume is extended from 20 message entries (standard version) to up to 100 entries.</p> <p>Data logging (line recorder):</p> <ul style="list-style-type: none"> ▪ Memory capacity for up to 1000 measured values is activated. ▪ 250 measured values can be output via each of the 4 memory channels. The recording interval can be defined and configured by the user. ▪ Measured value logs can be accessed via the local display or operating tool e.g. FieldCare, DeviceCare or Web server.

Heartbeat Technology

Package	Description
Heartbeat Verification +Monitoring	<p>Heartbeat Verification Meets the requirement for traceable verification to DIN ISO 9001:2008 Chapter 7.6 a) "Control of monitoring and measuring equipment".</p> <ul style="list-style-type: none"> ▪ Functional testing in the installed state without interrupting the process. ▪ Traceable verification results on request, including a report. ▪ Simple testing process via local operation or other operating interfaces. ▪ Clear measuring point assessment (pass/fail) with high test coverage within the framework of manufacturer specifications. ▪ Extension of calibration intervals according to operator's risk assessment. <p>Heartbeat Monitoring Continuously supplies data, which are characteristic of the measuring principle, to an external condition monitoring system for the purpose of preventive maintenance or process analysis. These data enable the operator to:</p> <ul style="list-style-type: none"> ▪ Draw conclusions - using these data and other information - about the impact process influences (such as corrosion, abrasion, buildup etc.) have on the measuring performance over time. ▪ Schedule servicing in time. ▪ Monitor the process or product quality, e.g. gas pockets.





Cleaning	Package	Description
	Electrode cleaning circuit (ECC)	The electrode cleaning circuit (ECC) function has been developed to have a solution for applications where magnetite (Fe ₃ O ₄) deposits frequently occur (e.g. hot water). Since magnetite is highly conductive this build up leads to measuring errors and ultimately to the loss of signal. The application package is designed to AVOID build up of highly conductive matter and thin layers (typical of magnetite).







OPC-UA server	Package	Description
	OPC-UA-Server	The application package provides the user with an integrated OPC-UA server for comprehensive instrument services for IoT and SCADA applications.  Special Documentation for the "OPC-UA-Server" application package →  93.

Accessories

Various accessories, which can be ordered with the device or subsequently from Endress+Hauser, are available for the device. Detailed information on the order code in question is available from your local Endress+Hauser sales center or on the product page of the Endress+Hauser website: www.endress.com.

Device-specific accessories For the transmitter





Accessories	Description
Proline 300 transmitter	Transmitter for replacement or storage. Use the order code to define the following specifications: <ul style="list-style-type: none"> ▪ Approvals ▪ Output ▪ Input ▪ Display/operation ▪ Housing ▪ Software  Order code: 5X3BXX  Installation Instructions EA01150
Remote display and operating module DKX001	<ul style="list-style-type: none"> ▪ If ordered directly with the measuring device: Order code for "Display; operation", option O "Separate 4-line display, illum.; 10 m (30 ft)Cable; touch control". ▪ If ordered separately: <ul style="list-style-type: none"> - Measuring device: order code for "Display; operation", option M "None, prepared for separate display". - DKX001: Via the separate product structure DKX001. ▪ If ordered subsequently: DKX001: Via the separate product structure DKX001. <p>Mounting bracket for DKX001</p> <ul style="list-style-type: none"> ▪ Ordered directly with the DKX001: Order code for "Enclosed accessories", option RA "Mounting bracket, 1/2" pipe". ▪ If ordered subsequently: order number: 71340960 <p>Connecting cable (replacement cable) Via the separate product structure: DKX002</p>  Further information on display and operating module DKX001 →  74.  Special Documentation SD01763D



External WLAN antenna	<p>External WLAN antenna with 1.5 m (59.1 in) connecting cable and two angle brackets. Order code for "Enclosed accessories", option P8 "Wireless antenna wide area".</p> <ul style="list-style-type: none">  The external WLAN antenna is not suitable for use in hygienic applications. Further information on the WLAN interface →  80. <p> Order number: 71351317</p> <p> Installation Instructions EA01238D</p>
Protective cover	<p>Is used to protect the measuring device from the effects of the weather: e.g. rainwater, excess heating from direct sunlight.</p> <p> Order number: 71343505</p> <p> Installation Instructions EA01160</p>
Ground cable	Set, consisting of two ground cables for potential equalization.

For the sensor



Accessories	Description
Ground disks	<p>Are used to ground the medium in lined measuring tubes to ensure proper measurement.</p> <p> For details, see Installation Instructions EA00070D</p>

Communication-specific accessories

Accessories	Description
Commubox FXA195 HART	<p>For intrinsically safe HART communication with FieldCare via the USB interface.</p> <p> Technical Information TI00404F</p>
HART Loop Converter HMX50	<p>Is used to evaluate and convert dynamic HART process variables to analog current signals or limit values.</p> <ul style="list-style-type: none">  Technical Information TI00429F Operating Instructions BA00371F
Fieldgate FXA320	<p>Gateway for the remote monitoring of connected 4-20 mA measuring devices via a Web browser.</p> <p> Technical Information TI00025S</p> <p>Operating Instructions BA00053S</p>
Fieldgate FXA520	<p>Gateway for the remote diagnostics and remote configuration of connected HART measuring devices via a Web browser.</p> <p> Technical Information TI00025S</p> <p>Operating Instructions BA00051S</p>
Field Xpert SFX350	<p>Field Xpert SFX350 is a mobile computer for commissioning and maintenance. It enables efficient device configuration and diagnostics for HART and FOUNDATION Fieldbus devices and can be used in non-hazardous areas.</p> <p> Operating Instructions BA01202S</p>

Field Xpert SFX370	<p>Field Xpert SFX370 is a mobile computer for commissioning and maintenance. It enables efficient device configuration and diagnostics for HART and FOUNDATION Fieldbus devices and can be used in the non-hazardous area and in the hazardous area.</p> <p> Operating Instructions BA01202S</p>
Field Xpert SMT70	<p>The Field Xpert SMT70 tablet PC for device configuration enables mobile plant asset management in hazardous and non-hazardous areas. It is suitable for commissioning and maintenance staff to manage field instruments with a digital communication interface and to record progress.</p> <p>This tablet PC is designed as an all-in-one solution with a preinstalled driver library and is an easy-to-use, touch-sensitive tool which can be used to manage field instruments throughout their entire life cycle.</p> <p> <ul style="list-style-type: none"> ▪ Technical Information TI01342S ▪ Operating Instructions BA01709S ▪ Product page: www.endress.com/smt70 </p>

Service-specific accessories

Accessories	Description
Applicator	<p>Software for selecting and sizing Endress+Hauser measuring devices:</p> <ul style="list-style-type: none"> ▪ Choice of measuring devices for industrial requirements ▪ Calculation of all the necessary data for identifying the optimum flowmeter: e.g. nominal diameter, pressure loss, flow velocity and accuracy. ▪ Graphic illustration of the calculation results ▪ Determination of the partial order code, administration, documentation and access to all project-related data and parameters over the entire life cycle of a project. <p>Applicator is available:</p> <ul style="list-style-type: none"> ▪ Via the Internet: https://portal.endress.com/webapp/applicator ▪ As a downloadable DVD for local PC installation.
W@M	<p>W@M Life Cycle Management</p> <p>Improved productivity with information at your fingertips. Data relevant to a plant and its components is generated from the first stages of planning and during the asset's complete life cycle.</p> <p>W@M Life Cycle Management is an open and flexible information platform with online and on-site tools. Instant access for your staff to current, in-depth data shortens your plant's engineering time, speeds up procurement processes and increases plant uptime.</p> <p>Combined with the right services, W@M Life Cycle Management boosts productivity in every phase. For more information, visit www.endress.com/lifecyclemanagement</p>
FieldCare	<p>FDT-based plant asset management tool from Endress+Hauser.</p> <p>It can configure all smart field units in your system and helps you manage them. By using the status information, it is also a simple but effective way of checking their status and condition.</p> <p> Operating Instructions BA00027S and BA00059S</p>
DeviceCare	<p>Tool to connect and configure Endress+Hauser field devices.</p> <p> Innovation brochure IN01047S</p>

System components

Accessories	Description
Memograph M graphic data manager	<p>The Memograph M graphic data manager provides information on all the relevant measured variables. Measured values are recorded correctly, limit values are monitored and measuring points analyzed. The data are stored in the 256 MB internal memory and also on a SD card or USB stick.</p> <p> <ul style="list-style-type: none"> ▪ Technical Information TI00133R ▪ Operating Instructions BA00247R </p>

Supplementary documentation



For an overview of the scope of the associated Technical Documentation, refer to the following:

- *W@M Device Viewer* (www.endress.com/deviceviewer): Enter the serial number from nameplate
- *Endress+Hauser Operations App*: Enter the serial number from the nameplate or scan the 2D matrix code (QR code) on the nameplate

Standard documentation Brief Operating Instructions

Brief Operating Instructions for the sensor

Measuring device	Documentation code
Proline Promag P	KA01290D

Brief Operating Instructions for transmitter

Measuring device	Documentation code						
	HART	FOUNDATION Fieldbus	PROFIBUS PA	PROFIBUS DP	Modbus RS485	EtherNet/IP	PROFINET
Proline 300	KA01308D	KA01294D	KA01405D	KA01385D	KA01310D	KA01338D	KA01340D

Operating Instructions

Measuring device	Documentation code						
	HART	FOUNDATION Fieldbus	PROFIBUS PA	PROFIBUS DP	Modbus RS485	EtherNet/IP	PROFINET
Promag P 300	BA01393D	BA01478D	BA01397D	BA01853D	BA01395D	BA01717D	BA01719D

Description of Device Parameters

Measuring device	Documentation code						
	HART	FOUNDATION Fieldbus	PROFIBUS PA	PROFIBUS DP	Modbus RS485	EtherNet/IP	PROFINET
Promag 300	GP01051D	GP01098D	GP01052D	GP01135D	GP01053D	GP01113D	GP01112D

Device-dependent additional documentation

Safety instructions

Safety instructions for electrical equipment for hazardous areas.

Contents	Documentation code
ATEX/IECEX Ex d/Ex de	XA01414D
ATEX/IECEX Ex ec	XA01514D
cCSAus XP	XA01515D
cCSAus Ex d/ Ex de	XA01516D
cCSAus Ex nA	XA01517D
INMETRO Ex d/Ex de	XA01518D
INMETRO Ex ec	XA01519D
NEPSI Ex d/Ex de	XA01520D
NEPSI Ex nA	XA01521D

Remote display and operating module DKX001

Contents	Documentation code
ATEX/IECEX Ex i	XA01494D
ATEX/IECEX Ex ec	XA01498D
cCSAus IS	XA01499D
cCSAus Ex nA	XA01513D
INMETRO Ex i	XA01500D
INMETRO Ex ec	XA01501D
NEPSI Ex i	XA01502D
NEPSI Ex nA	XA01503D

Special Documentation

Contents	Documentation code
Information on the Pressure Equipment Directive	SD01614D
Functional Safety Manual	SD01740D
Radio approvals for WLAN interface for A309/A310 display module	SD01793D
Remote display and operating module DKX001	SD01763D
OPC-UA Server ¹⁾	SD02043D

1) This Special Documentation is only available for device versions with a HART output.

Contents	Documentation code						
	HART	FOUNDATION Fieldbus	PROFIBUS PA	PROFIBUS DP	Modbus RS485	PROFINET	EtherNet/IP
Heartbeat Technology	SD01640D	SD01742D	SD01744D	SD02206D	SD01743D	SD01986D	SD01980D
Web server	SD01654D	SD01657D	SD01656D	SD02235D	SD01655D	SD01977D	SD01976D

Installation Instructions

Contents	Comment
Installation instructions for spare part sets and accessories	Documentation code: specified for each individual accessory .

Registered trademarks

HART®

Registered trademark of the FieldComm Group, Austin, Texas, USA

PROFIBUS®

Registered trademark of the PROFIBUS User Organization, Karlsruhe, Germany

FOUNDATION™ Fieldbus

Registration-pending trademark of the FieldComm Group, Austin, Texas, USA

Modbus®

Registered trademark of SCHNEIDER AUTOMATION, INC.

EtherNet/IP™

Trademark of ODVA, Inc.

PROFINET®

Registered trademark of the PROFIBUS User Organization, Karlsruhe, Germany

www.addresses.endress.com
