

Technical Information

Proline Promass H 500

Coriolis flowmeter

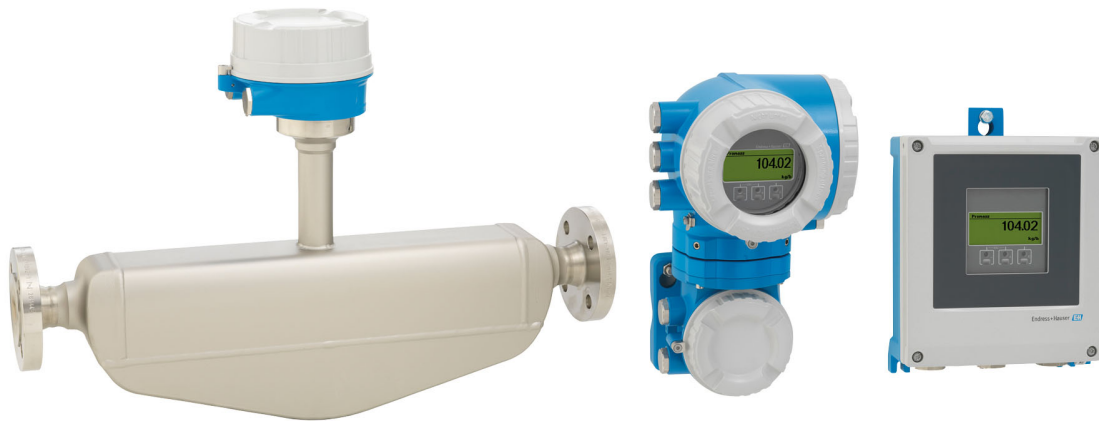

The chemically resistant single-tube flowmeter, as remote version with up to 4 I/Os

Application

- Measuring principle operates independently of physical fluid properties such as viscosity or density
- Measuring highly accurately liquids and gases in applications requiring highest corrosion resistance

Device properties

- Measuring tube made of Tantalum, Zirconium
- Nominal diameter: DN 8 to 50 ($\frac{3}{8}$ to 2")
- Medium temperature up to +205 °C (+401 °F)
- Remote version with up to 4 I/Os
- Backlit display with touch control and WLAN access
- Standard cable between sensor and transmitter

Your benefits

- Maximum safety for chemically aggressive fluids – corrosion-resistant wetted parts
- Fewer process measuring points – multivariable measurement (flow, density, temperature)
- Space-saving installation – no inlet/outlet run needs
- Full access to process and diagnostic information – numerous, freely combinable I/Os and fieldbuses
- Reduced complexity and variety – freely configurable I/O functionality
- Integrated verification – Heartbeat Technology

Table of contents





About this document	4	Storage temperature	58
Symbols used	4	Climate class	58
Function and system design	5	Degree of protection	58
Measuring principle	5	Vibration resistance	58
Measuring system	7	Shock resistance	58
Equipment architecture	8	Shock resistance	58
Safety	9	Interior cleaning	58
Input	11	Electromagnetic compatibility (EMC)	58
Measured variable	11	Process	58
Measuring range	11	Medium temperature range	58
Operable flow range	12	Density	59
Input signal	12	Pressure-temperature ratings	59
Output	14	Sensor housing	61
Output and input variants	14	Flow limit	61
Output signal	15	Pressure loss	61
Signal on alarm	19	System pressure	61
Ex connection data	21	Thermal insulation	62
Low flow cut off	22	Heating	62
Galvanic isolation	22	Vibrations	62
Protocol-specific data	23	Mechanical construction	63
Power supply	28	Dimensions in SI units	63
Terminal assignment	28	Dimensions in US units	70
Device plugs available	29	Weight	76
Pin assignment, device plug	30	Materials	77
Supply voltage	31	Process connections	79
Power consumption	31	Surface roughness	79
Current consumption	31	Operability	80
Power supply failure	31	Operating concept	80
Electrical connection	32	Languages	80
Potential equalization	42	Local operation	80
terminals	43	Remote operation	81
Cable entries	43	Service interface	86
Cable specification	43	Network integration	88
Performance characteristics	48	Supported operating tools	89
Reference operating conditions	48	HistoROM data management	90
Maximum measured error	48	Certificates and approvals	91
Repeatability	49	CE mark	91
Response time	50	C-Tick symbol	91
Influence of ambient temperature	50	Ex approval	91
Influence of medium temperature	50	Pharmaceutical compatibility	94
Influence of medium pressure	51	Functional safety	94
Design fundamentals	51	HART certification	94
Installation	52	FOUNDATION Fieldbus certification	95
Mounting location	52	Certification PROFIBUS	95
Orientation	53	EtherNet/IP certification	95
Inlet and outlet runs	54	Certification PROFINET	95
Mounting the transmitter housing	55	Pressure Equipment Directive	95
Special mounting instructions	56	Radio approval	95
Environment	57	Additional certification	95
Ambient temperature range	57	Other standards and guidelines	96
		Ordering information	96

Application packages	96
Diagnostics functions	97
Heartbeat Technology	97
Concentration	97
Special density	97
OPC-UA server	97
Accessories	98
Device-specific accessories	98
Communication-specific accessories	99
Service-specific accessories	100
System components	100
Supplementary documentation	101
Standard documentation	101
Device-dependent additional documentation	102
Registered trademarks	102





About this document

Symbols used









Electrical symbols

Symbol	Meaning
	Direct current
	Alternating current
	Direct current and alternating current
	Ground connection A grounded terminal which, as far as the operator is concerned, is grounded via a grounding system.
	Protective Earth (PE) A terminal which must be connected to ground prior to establishing any other connections. The ground terminals are situated inside and outside the device: <ul style="list-style-type: none"> ▪ Inner ground terminal: Connects the protective earth to the mains supply. ▪ Outer ground terminal: Connects the device to the plant grounding system.



Communication symbols

Symbol	Meaning
	Wireless Local Area Network (WLAN) Communication via a wireless, local network.
	LED Light emitting diode is off.
	LED Light emitting diode is on.
	LED Light emitting diode is flashing.

Symbols for certain types of information

Symbol	Meaning
	Permitted Procedures, processes or actions that are permitted.
	Preferred Procedures, processes or actions that are preferred.
	Forbidden Procedures, processes or actions that are forbidden.
	Tip Indicates additional information.
	Reference to documentation.
	Reference to page.
	Reference to graphic.
	Visual inspection.

Symbols in graphics

Symbol	Meaning
1, 2, 3, ...	Item numbers
1, 2, 3, ...	Series of steps
A, B, C, ...	Views
A-A, B-B, C-C, ...	Sections
	Hazardous area
	Safe area (non-hazardous area)
	Flow direction

Function and system design

Measuring principle

The measuring principle is based on the controlled generation of Coriolis forces. These forces are always present in a system when both translational and rotational movements are superimposed.

$$F_c = 2 \cdot \Delta m (v \cdot \omega)$$

F_c = Coriolis force

Δm = moving mass

ω = rotational velocity

v = radial velocity in rotating or oscillating system

The amplitude of the Coriolis force depends on the moving mass Δm , its velocity v in the system and thus on the mass flow. Instead of a constant rotational velocity ω , the sensor uses oscillation.

In the sensor, an oscillation is produced in the measuring tube. The Coriolis forces produced at the measuring tube cause a phase shift in the tube oscillations (see illustration):

- If there is zero flow (i.e. when the fluid stands still), the oscillation measured at points A and B has the same phase (no phase difference) (1).
- Mass flow causes deceleration of the oscillation at the inlet of the tubes (2) and acceleration at the outlet (3).

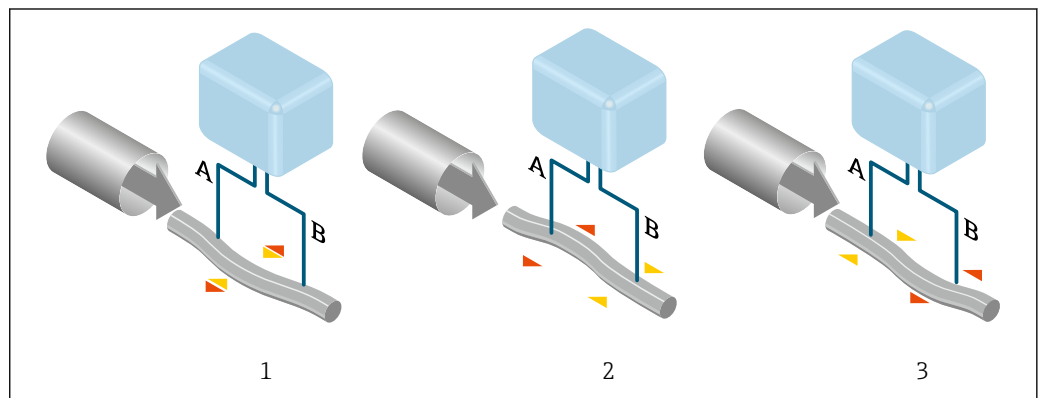

A0029932

The phase difference (A-B) increases with increasing mass flow. Electrodynamical sensors register the tube oscillations at the inlet and outlet. System balance is created by exciting an eccentrically arranged swinging mass to antiphase oscillation. The measuring principle operates independently of temperature, pressure, viscosity, conductivity and flow profile.

Density measurement

The measuring tube is continuously excited at its resonance frequency. A change in the mass and thus the density of the oscillating system (comprising measuring tube and fluid) results in a corresponding, automatic adjustment in the oscillation frequency. Resonance frequency is thus a function of medium density. The microprocessor utilizes this relationship to obtain a density signal.

Volume measurement

Together with the measured mass flow, this is used to calculate the volume flow.

Temperature measurement

The temperature of the measuring tube is determined in order to calculate the compensation factor due to temperature effects. This signal corresponds to the process temperature and is also available as an output signal.

Measuring system

The measuring system consists of a transmitter and a sensor. The transmitter and sensor are mounted in physically separate locations. They are interconnected by connecting cables.



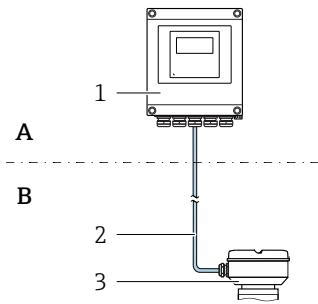
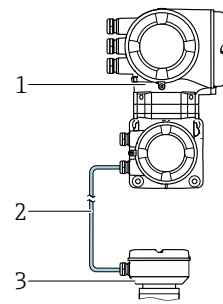

Transmitter

Two versions of the transmitter are available.

Proline 500 – digital	Proline 500
<p>For use in applications not required to meet special requirements due to ambient or operating conditions.</p>  <p>A Non-hazardous area or Zone 2; Class I, Division 2 B Non-hazardous area or Zone 2; Class I, Division 2 or Zone 1; Class I, Division 1 1 Transmitter 2 Connecting cable: cable, separate, standard 3 Sensor connection housing with integrated ISEM</p> <ul style="list-style-type: none"> Flexible and cost-effective separate installation. A standard cable can be used as the connecting cable. Electronics in the transmitter housing, ISEM (intelligent sensor electronics module) in the sensor connection housing Signal transmission: digital Order code for "Integrated ISEM electronics", option A "Sensor" 	<p>For use in applications required to meet special requirements due to ambient or operating conditions.</p>  <p>Non-hazardous area or Zone 2; Class I, Division 2 or Zone 1; Class I, Division 1 1 Transmitter with integrated ISEM 2 Connecting cable: cable, separate 3 Sensor connection housing</p> <p>Application examples for sensors without electronics:</p> <ul style="list-style-type: none"> Strong vibrations at the sensor. Sensor in underground installations. Permanent immersion of sensor in water, IP68 ingress protection. Electronics and ISEM (intelligent sensor electronics module) in the transmitter housing Signal transmission: analog Order code for "Integrated ISEM electronics", option B "Transmitter"
<p>Connecting cable (can be ordered in various lengths) → 98</p>	
<ul style="list-style-type: none"> Length: <ul style="list-style-type: none"> Zone 2; Class I, Division 2: max. 300 m (1000 ft) Zone 1; Class I, Division 1: max. 150 m (500 ft) Standard cable with common shield (pair-stranded) 	<ul style="list-style-type: none"> Length: max. 20 m (65 ft) Cable with a common shield and individual shielded cores (3 pairs)
<p>Hazardous area</p>	
<p>Use in: Zone 2; Class I, Division 2 Mixed installation is possible:</p> <ul style="list-style-type: none"> Sensor: Zone 1; Class I, Division 1 Transmitter: Zone 2; Class I, Division 2 	<p>Use in: Zone 1; Class I, Division 1 oder Zone 2; Class I, Division 2</p>
<p>Device versions and materials</p>	
<ul style="list-style-type: none"> Transmitter housing <ul style="list-style-type: none"> Aluminum, coated: aluminum, AlSi10Mg, coated Material: polycarbonate Material of window in transmitter housing <ul style="list-style-type: none"> Aluminum, coated: glass Polycarbonate: plastic 	<ul style="list-style-type: none"> Transmitter housing <ul style="list-style-type: none"> Aluminum, coated: aluminum, AlSi10Mg, coated Cast, stainless: cast, stainless steel, 1.4409 (CF3M) similar to 316L Window material: glass
<p>Configuration</p>	
<ul style="list-style-type: none"> External operation via 4-line, backlit, graphic local display with touch control and guided menus ("Make-it-run" wizards) for application-specific commissioning. Via service interface or WLAN interface: <ul style="list-style-type: none"> Operating tools (e.g. FieldCare, DeviceCare, SmartBlue app) Web server (access via Web browser, e.g. Microsoft Internet Explorer, Microsoft Edge) 	

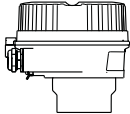
Sensor connection housing

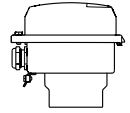
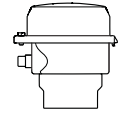
Different versions of the connection housing are available.

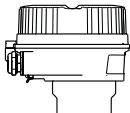
	<p>Order code for "Sensor connection housing", option A, "Aluminum, coated": Aluminum, AISi10Mg, coated</p> <p> This device version is only available in conjunction with the Proline 500 – digital transmitter.</p>
	<p>Order code for "Sensor connection housing", option B, "Stainless":</p> <ul style="list-style-type: none"> ▪ Hygienic version, stainless steel 1.4301 (304) ▪ Optional: order code for "Sensor feature", option CC "Hygienic version, for maximum corrosion resistance": stainless steel 1.4404 (316L)
	<p>Order code for "Sensor connection housing", option C, "Ultra-compact hygienic, stainless": Hygienic version, stainless steel 1.4301 (304)</p> <p> This device version is only available in conjunction with the Proline 500 – digital transmitter.</p>
	<p>Order code for "Sensor connection housing", option L, "Cast, stainless": 1.4409 (CF3M) similar to 316L</p>

Sensor

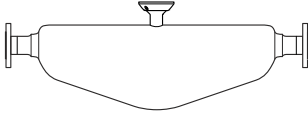
<p>Promass H</p>  <p style="text-align: right; font-size: small;">A0026714</p>	<ul style="list-style-type: none"> ▪ Single bent tube ▪ Simultaneous measurement of flow, volume flow, density and temperature (multivariable) ▪ Minimal pressure losses and chemical-resistant materials ▪ Nominal diameter range: DN 8 to 50 (3/8 to 2") ▪ Materials: <ul style="list-style-type: none"> - Sensor: stainless steel, 1.4301 (304) - Measuring tubes: zirconium 702 (UNS R60702); tantalum 2.5W - Process connections: stainless steel, 1.4301 (304), wetted parts: zirconium 702 (UNS R60702); tantalum
--------------------------------------------------------------------------------------------------------------------------------------------------------------------------	---------------------------------------------------------------------------------------------------------------------------------------------------------------------------------------------------------------------------------------------------------------------------------------------------------------------------------------------------------------------------------------------------------------------------------------------------------------------------------------------------------------------------------------------------------------------------------------------------------------------------

Equipment architecture

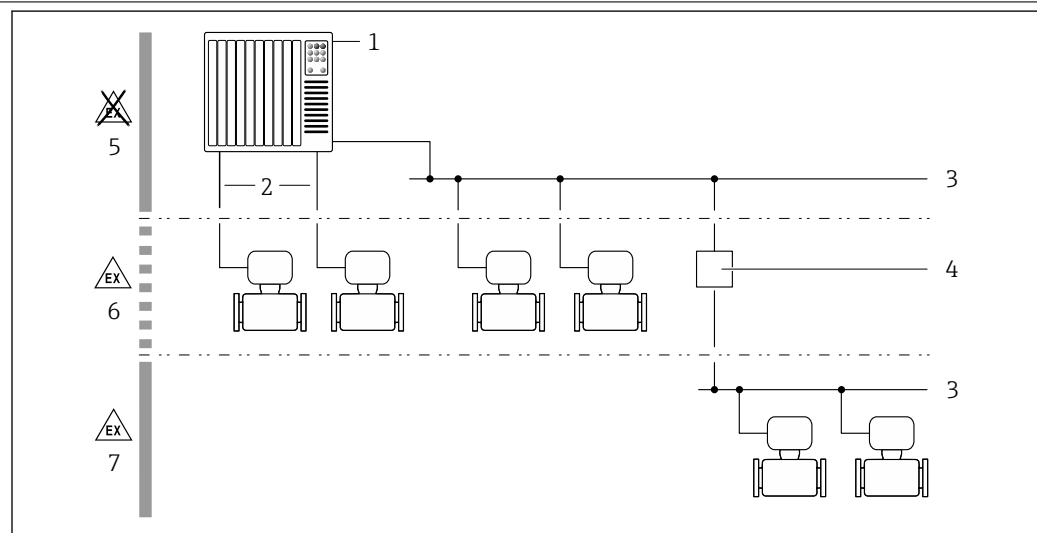

 1 Possibilities for integrating measuring devices into a system

- 1 Control system (e.g. PLC)
- 2 Connecting cable (0/4 to 20 mA HART etc.)
- 3 Fieldbus
- 4 Segment coupler
- 5 Non-hazardous area
- 6 Hazardous area: Zone 2; Class I, Division 2
- 7 Hazardous area: Zone 1; Class I, Division 1

Safety**IT security**

Our warranty is valid only if the device is installed and used as described in the Operating Instructions. The device is equipped with security mechanisms to protect it against any inadvertent changes to the settings.

IT security measures, which provide additional protection for the device and associated data transfer, must be implemented by the operators themselves in line with their security standards.

Device-specific IT security

The device offers a range of specific functions to support protective measures on the operator's side. These functions can be configured by the user and guarantee greater in-operation safety if used correctly. An overview of the most important functions is provided in the following section.

Function/interface	Factory setting	Recommendation
Write protection via hardware write protection switch → 9	Not enabled.	On an individual basis following risk assessment.
Access code (also applies for Web server login or FieldCare connection) → 9	Not enabled (0000).	Assign a customized access code during commissioning.
WLAN (order option in display module)	Enabled.	On an individual basis following risk assessment.
WLAN security mode	Enabled (WPA2-PSK)	Do not change.
WLAN passphrase (password) → 10	Serial number	Assign a customized access code during commissioning.
WLAN mode	Access Point	On an individual basis following risk assessment.
Web server → 10	Enabled.	On an individual basis following risk assessment.
CDI-RJ45 service interface → 10	–	On an individual basis following risk assessment.

Protecting access via hardware write protection

Write access to the device parameters via the local display, Web browser or operating tool (e.g. FieldCare, DeviceCare) can be disabled via a write protection switch (DIP switch on the motherboard). When hardware write protection is enabled, only read access to the parameters is possible.

Hardware write protection is disabled when the device is delivered.

Protecting access via a password

Different passwords are available to protect write access to the device parameters or access to the device via the WLAN interface.

- **User-specific access code**
Protect write access to the device parameters via the local display, Web browser or operating tool (e.g. FieldCare, DeviceCare). Access authorization is clearly regulated through the use of a user-specific access code.
- **WLAN passphrase**
The network key protects a connection between an operating unit (e.g. notebook or tablet) and the device via the WLAN interface which can be ordered as an option.
- **Infrastructure mode**
When the device is operated in infrastructure mode, the WLAN passphrase corresponds to the WLAN passphrase configured on the operator side.

User-specific access code

Write access to the device parameters via the local display, Web browser or operating tool (e.g. FieldCare, DeviceCare) can be protected by the modifiable, user-specific access code.

WLAN passphrase: Operation as WLAN access point

A connection between an operating unit (e.g. notebook or tablet) and the device via the WLAN interface, which can be ordered as an optional extra, is protected by the network key. The WLAN authentication of the network key complies with the IEEE 802.11 standard.

When the device is delivered, the network key is pre-defined depending on the device. It can be changed via the **WLAN settings** submenu in the **WLAN passphrase** parameter.

Infrastructure mode

A connection between the device and WLAN access point is protected by means of an SSID and passphrase on the system side. Please contact the relevant system administrator for access.

General notes on the use of passwords

- The access code and network key supplied with the device should be changed during commissioning.
- Follow the general rules for generating a secure password when defining and managing the access code or network key.
- The user is responsible for the management and careful handling of the access code and network key.

Access via Web server

The device can be operated and configured via a Web browser with the integrated Web server. The connection is via the service interface (CDI-RJ45) or the WLAN interface. For device versions with the EtherNet/IP and PROFINET communication protocols, the connection can also be established via the terminal connection for signal transmission with EtherNet/IP or PROFINET (RJ45 connector).

The Web server is enabled when the device is delivered. The Web server can be disabled if necessary (e.g. after commissioning) via the **Web server functionality** parameter.

The device and status information can be hidden on the login page. This prevents unauthorized access to the information.



For detailed information on device parameters, see:
The "Description of Device Parameters" document → 101

Access via OPC-UA

The "OPC UA Server" application package is available in the device version with the HART communication protocol → 97.

The device can communicate with OPC UA clients using the "OPC UA Server" application package.

The OPC UA server integrated in the device can be accessed via the WLAN access point using the WLAN interface - which can be ordered as an optional extra - or the service interface (CDI- RJ45) via Ethernet network. Access rights and authorization as per separate configuration.

The following Security Modes are supported as per the OPC UA Specification (IEC 62541):

- None
- Basic128Rsa15 – signed
- Basic128Rsa15 – signed and encrypted

Access via service interface (CDI-RJ45)

The device can be connected to a network via the service interface (CDI-RJ45). Device-specific functions guarantee the secure operation of the device in a network.

The use of relevant industrial standards and guidelines that have been defined by national and international safety committees, such as IEC/ISA62443 or the IEEE, is recommended. This includes organizational security measures such as the assignment of access authorization as well as technical measures such as network segmentation.



The device can be integrated in a ring topology. The device is integrated via the terminal connection for signal transmission (output 1) and the connection to the service interface (CDI-RJ45) → 84.

Input

Measured variable	Direct measured variables
	<ul style="list-style-type: none"> ■ Mass flow ■ Density ■ Temperature
	Calculated measured variables
	<ul style="list-style-type: none"> ■ Volume flow ■ Corrected volume flow ■ Reference density

Measuring range	Measuring range for liquids			
	DN		Measuring range full scale values $\dot{m}_{\min(F)}$ to $\dot{m}_{\max(F)}$	
	[mm]	[in]	[kg/h]	[lb/min]
	8	$\frac{3}{8}$	0 to 2 000	0 to 73.50
	15	$\frac{1}{2}$	0 to 6 500	0 to 238.9
	25	1	0 to 18 000	0 to 661.5
	40	$1\frac{1}{2}$	0 to 45 000	0 to 1 654
	50	2	0 to 70 000	0 to 2 573

Measuring range for gases



Measuring ranges valid only for Promass H with tantalum 2.5W.

The full scale value depends on the density and the sound velocity of the gas used and can be calculated with the formula below:

$$\dot{m}_{\max(G)} = \text{minimum} (\dot{m}_{\max(F)} \cdot \rho_G : x ; \rho_G \cdot c_G \cdot \pi/2 \cdot (d_i)^2 \cdot 3600)$$

$\dot{m}_{\max(G)}$	Maximum full scale value for gas [kg/h]
$\dot{m}_{\max(F)}$	Maximum full scale value for liquid [kg/h]
$\dot{m}_{\max(G)} < \dot{m}_{\max(F)}$	$\dot{m}_{\max(G)}$ can never be greater than $\dot{m}_{\max(F)}$
ρ_G	Gas density in [kg/m ³] at operating conditions
x	Constant dependent on nominal diameter
c_G	Sound velocity (gas) [m/s]
d_i	Measuring tube internal diameter [m]

DN		x
[mm]	[in]	[kg/m³]
8	$\frac{3}{8}$	60
15	$\frac{1}{2}$	80
25	1	90
40	$1\frac{1}{2}$	90
50	2	90

 To calculate the measuring range, use the *Applicator* sizing tool →  100

Recommended measuring range

"Flow limit" section →  61

Operable flow range

Over 1000 : 1.

Flow rates above the preset full scale value do not override the electronics unit, with the result that the totalizer values are registered correctly.

Input signal**Input and output versions**

→  14

External measured values

To increase the accuracy of certain measured variables or to calculate the corrected volume flow for gases, the automation system can continuously write different measured values to the measuring device:

- Operating pressure to increase accuracy (Endress+Hauser recommends the use of a pressure measuring device for absolute pressure, e.g. Cerabar M or Cerabar S)
- Medium temperature to increase accuracy (e.g. iTEMP)
- Reference density for calculating the corrected volume flow for gases

 Various pressure transmitters and temperature measuring devices can be ordered from Endress +Hauser: see "Accessories" section →  100

It is recommended to read in external measured values to calculate the corrected volume flow.

HART protocol

The measured values are written from the automation system to the measuring device via the HART protocol. The pressure transmitter must support the following protocol-specific functions:

- HART protocol
- Burst mode

Current input

The measured values are written from the automation system to the measuring device via the current input →  12.

Digital communication

The measured values can be written from the automation system to the measuring via:

- FOUNDATION Fieldbus
- PROFIBUS DP
- PROFIBUS PA
- Modbus RS485
- EtherNet/IP
- PROFINET

Current input 0/4 to 20 mA

Current input	0/4 to 20 mA (active/passive)
Current span	<ul style="list-style-type: none"> ▪ 4 to 20 mA (active) ▪ 0/4 to 20 mA (passive)
Resolution	1 μ A
Voltage drop	Typically: 0.6 to 2 V for 3.6 to 22 mA (passive)
Maximum input voltage	\leq 30 V (passive)
Open-circuit voltage	\leq 28.8 V (active)
Possible input variables	<ul style="list-style-type: none"> ▪ Pressure ▪ Temperature ▪ Density

Status input

Maximum input values	<ul style="list-style-type: none"> ▪ DC -3 to 30 V ▪ If status input is active (ON): $R_i > 3 \text{ k}\Omega$
Response time	Adjustable: 5 to 200 ms
Input signal level	<ul style="list-style-type: none"> ▪ Low signal: DC -3 to +5 V ▪ High signal: DC 12 to 30 V
Assignable functions	<ul style="list-style-type: none"> ▪ Off ▪ Reset the individual totalizers separately ▪ Reset all totalizers ▪ Flow override

Output

Output and input variants

Depending on the option selected for output/input 1, different options are available for the other outputs and inputs. Only one option can be selected for each output/input 1 to 4. The table must be read vertically (↓).

Example: If the option BA "4–20 mA HART" was selected for output/input 1, one of the options A, B, D, E, F, H, I or J is available for output 2, and one of the options A, B, D, E, F, H, I or J is available for output 3 and 4.

Order code for "Output; input 1" (020) →	Possible options									
Current output 4 to 20 mA HART	BA									
Current output 4 to 20 mA HART Ex i	↓	CA								
FOUNDATION Fieldbus		↓	SA							
FOUNDATION Fieldbus Ex i			↓	TA						
PROFIBUS DP				↓	LA					
PROFIBUS PA					↓	GA				
PROFIBUS PA Ex i						↓	HA			
Modbus RS485							↓	MA		
EtherNet/IP 2-port switch integrated								↓	NA	
PROFINET 2-port switch integrated									↓	RA
Order code for "Output; input 2" (021) →	↓	↓	↓	↓	↓	↓	↓	↓	↓	↓
Not assigned	A	A	A	A	A	A	A	A	A	A
Current output 0/4 to 20 mA	B		B		B	B		B	B	B
Current output 0/4 to 20 mA (Ex i)		C		C			C			
User configurable input/output ¹⁾	D		D		D	D		D	D	D
Pulse/frequency/switch output	E		E		E	E		E	E	E
Double pulse output ²⁾	F							F		
Pulse/frequency/switch output (Ex i)		G		G			G			
Relay output	H		H		H	H		H	H	H
Current input 0/4 to 20 mA	I		I		I	I		I	I	I
Status input	J		J		J	J		J	J	J
Order code for "Output; input 3" (022), "Output; input 4" (023) ³⁾ →	↓	↓	↓	↓	↓	↓	↓	↓	↓	↓
Not assigned	A	A	A	A	A	A	A	A	A	A
Current output 0/4 to 20 mA	B				B			B	B	B
Current output 0/4 to 20 mA (Ex i)		C								
User configurable input/output	D				D			D	D	D
Pulse/frequency/switch output	E				E			E	E	E
Double pulse output (slave) ^{2) 4)}	F							F		
Pulse/frequency/switch output (Ex i)		G								
Relay output	H				H			H	H	H
Current input 0/4 to 20 mA	I				I			I	I	I
Status input	J				J			J	J	J

1) A specific input or output can be assigned to a user configurable input/output → 18.



2) If double pulse output (F) is selected for output/input 2 (021), only the double pulse output (F) option is available for selection for output/input 3 (022).

3) The order code for "Output; input 4" (023) is only available for the Proline 500 – digital transmitter.

4) The double pulse output (F) option is not available for input/output 4.

Output signal

HART current output

Current output	4 to 20 mA HART
Current span	Can be set to: 4 to 20 mA (active/passive)  Ex-i, passive
Open-circuit voltage	DC 28.8 V (active)
Maximum input voltage	DC 30 V (passive)
Load	250 to 700 Ω
Resolution	0.38 μA
Damping	Configurable: 0.07 to 999 s
Assignable measured variables	<ul style="list-style-type: none"> ▪ Mass flow ▪ Volume flow ▪ Corrected volume flow ▪ Density ▪ Reference density ▪ Temperature ▪ Electronic temperature ▪ Oscillation frequency 0 ▪ Oscillation damping 0 ▪ Signal asymmetry ▪ Exciter current 0  The range of options increases if the measuring device has one or more application packages.

PROFIBUS PA

PROFIBUS PA	In accordance with EN 50170 Volume 2, IEC 61158-2 (MBP), galvanically isolated
Data transmission	31.25 kbit/s
Current consumption	10 mA
Permitted supply voltage	9 to 32 V
Bus connection	With integrated reverse polarity protection

PROFIBUS DP

Signal encoding	NRZ code
Data transfer	9.6 kBaud...12 MBaud

EtherNet/IP

Standards	In accordance with IEEE 802.3
------------------	-------------------------------

PROFINET

Standards	In accordance with IEEE 802.3
------------------	-------------------------------

FOUNDATION Fieldbus



FOUNDATION Fieldbus	H1, IEC 61158-2, galvanically isolated
Data transfer	31.25 kbit/s

Current consumption	10 mA
Permitted supply voltage	9 to 32 V
Bus connection	With integrated reverse polarity protection

Modbus RS485



Physical interface	RS485 in accordance with EIA/TIA-485 standard
Terminating resistor	Integrated, can be activated via DIP switches

Current output 0/4 to 20 mA

Current output	0/4 to 20 mA
Maximum output values	22.5 mA
Current span	Can be set to: <ul style="list-style-type: none"> ▪ 4 to 20 mA (active) ▪ 0/4 to 20 mA (passive)  Ex-i, passive
Open-circuit voltage	DC 28.8 V (active)
Maximum input voltage	DC 30 V (passive)
Load	0 to 700 Ω
Resolution	0.38 µA
Damping	Adjustable: 0.07 to 999 s
Assignable measured variables	<ul style="list-style-type: none"> ▪ Mass flow ▪ Volume flow ▪ Corrected volume flow ▪ Density ▪ Reference density ▪ Temperature ▪ Electronic temperature ▪ Oscillation frequency 0 ▪ Oscillation damping 0 ▪ Signal asymmetry ▪ Exciter current 0  The range of options increases if the measuring device has one or more application packages.

Pulse/frequency/switch output

Function	Can be set to pulse, frequency or switch output
Version	Open collector Can be set to: <ul style="list-style-type: none"> ▪ Active ▪ Passive  Ex-i, passive
Maximum input values	DC 30 V, 250 mA (passive)
Open-circuit voltage	DC 28.8 V (active)
Voltage drop	For 22.5 mA: ≤ DC 2 V
Pulse output	
Maximum input values	DC 30 V, 250 mA (passive)
Maximum output current	22.5 mA (active)

Open-circuit voltage	DC 28.8 V (active)
Pulse width	Adjustable: 0.05 to 2 000 ms
Maximum pulse rate	10 000 Impulse/s
Pulse value	Adjustable
Assignable measured variables	<ul style="list-style-type: none"> ▪ Mass flow ▪ Volume flow ▪ Corrected volume flow
Frequency output	
Maximum input values	DC 30 V, 250 mA (passive)
Maximum output current	22.5 mA (active)
Open-circuit voltage	DC 28.8 V (active)
Output frequency	Adjustable: end value frequency 2 to 10 000 Hz ($f_{max} = 12\,500$ Hz)
Damping	Adjustable: 0 to 999 s
Pulse/pause ratio	1:1
Assignable measured variables	<ul style="list-style-type: none"> ▪ Mass flow ▪ Volume flow ▪ Corrected volume flow ▪ Density ▪ Reference density ▪ Temperature ▪ Electronic temperature ▪ Oscillation frequency 0 ▪ Oscillation damping 0 ▪ Signal asymmetry ▪ Exciter current 0 <p> The range of options increases if the measuring device has one or more application packages.</p>
Switch output	
Maximum input values	DC 30 V, 250 mA (passive)
Open-circuit voltage	DC 28.8 V (active)
Switching behavior	Binary, conductive or non-conductive
Switching delay	Adjustable: 0 to 100 s
Number of switching cycles	Unlimited
Assignable functions	<ul style="list-style-type: none"> ▪ Off ▪ On ▪ Diagnostic behavior ▪ Limit value <ul style="list-style-type: none"> - Mass flow - Volume flow - Corrected volume flow - Density - Reference density - Temperature - Totalizer 1-3 ▪ Flow direction monitoring ▪ Status <ul style="list-style-type: none"> - Partially filled pipe detection - Low flow <p> The range of options increases if the measuring device has one or more application packages.</p>

Double pulse output

Function	Double pulse
Version	Open collector Can be set to: <ul style="list-style-type: none"> ■ Active ■ Passive
Maximum input values	DC 30 V, 250 mA (passive)
Open-circuit voltage	DC 28.8 V (active)
Voltage drop	For 22.5 mA: ≤ DC 2 V
Output frequency	Adjustable: 0 to 1000 Hz
Damping	Adjustable: 0 to 999 s
Pulse/pause ratio	1:1
Assignable measured variables	<ul style="list-style-type: none"> ■ Mass flow ■ Volume flow ■ Corrected volume flow ■ Density ■ Reference density ■ Temperature <p> The range of options increases if the measuring device has one or more application packages.</p>

Relay output

Function	Switch output
Version	Relay output, galvanically isolated
Switching behavior	Can be set to: <ul style="list-style-type: none"> ■ NO (normally open), factory setting ■ NC (normally closed)
Maximum switching capacity (passive)	<ul style="list-style-type: none"> ■ DC 30 V, 0.1 A ■ AC 30 V, 0.5 A
Assignable functions	<ul style="list-style-type: none"> ■ Off ■ On ■ Diagnostic behavior ■ Limit value <ul style="list-style-type: none"> - Mass flow - Volume flow - Corrected volume flow - Density - Reference density - Temperature - Totalizer 1-3 ■ Flow direction monitoring ■ Status <ul style="list-style-type: none"> - Partially filled pipe detection - Low flow <p> The range of options increases if the measuring device has one or more application packages.</p>

User configurable input/output

One specific input or output is assigned to a user-configurable input/output (configurable I/O) during device commissioning.

The following inputs and outputs are available for assignment:

- Choice of current output: 4 to 20 mA (active), 0/4 to 20 mA (passive)
- Pulse/frequency/switch output
- Choice of current input: 4 to 20 mA (active), 0/4 to 20 mA (passive)
- Status input

The technical values correspond to those of the inputs and outputs described in this section.

Signal on alarm

Depending on the interface, failure information is displayed as follows:

HART current output

Device diagnostics	Device condition can be read out via HART Command 48
---------------------------	------------------------------------------------------

PROFIBUS PA

Status and alarm messages	Diagnostics in accordance with PROFIBUS PA Profile 3.02
Failure current FDE (Fault Disconnection Electronic)	0 mA

PROFIBUS DP

Status and alarm messages	Diagnostics in accordance with PROFIBUS PA Profile 3.02
----------------------------------	---------------------------------------------------------

EtherNet/IP

Device diagnostics	Device condition can be read out in Input Assembly
---------------------------	----------------------------------------------------

PROFINET

Device diagnostics	According to "Application Layer protocol for decentralized periphery", Version 2.3
---------------------------	------------------------------------------------------------------------------------

FOUNDATION Fieldbus

Status and alarm messages	Diagnostics in accordance with FF-891
Failure current FDE (Fault Disconnection Electronic)	0 mA

Modbus RS485

Failure mode	Choose from: <ul style="list-style-type: none"> ▪ NaN value instead of current value ▪ Last valid value
---------------------	---------------------------------------------------------------------------------------------------------------------------------

Current output 0/4 to 20 mA

4 to 20 mA

Failure mode	Choose from: <ul style="list-style-type: none"> ▪ 4 to 20 mA in accordance with NAMUR recommendation NE 43 ▪ 4 to 20 mA in accordance with US ▪ Min. value: 3.59 mA ▪ Max. value: 22.5 mA ▪ Freely definable value between: 3.59 to 22.5 mA ▪ Actual value ▪ Last valid value
---------------------	----------------------------------------------------------------------------------------------------------------------------------------------------------------------------------------------------------------------------------------------------------------------------------------------------------------------------------------------------

0 to 20 mA

Failure mode	Choose from: <ul style="list-style-type: none"> ▪ Maximum alarm: 22 mA ▪ Freely definable value between: 0 to 20.5 mA
---------------------	-----------------------------------------------------------------------------------------------------------------------------------------------

Pulse/frequency/switch output

Pulse output	
Failure mode	Choose from: <ul style="list-style-type: none"> ▪ Actual value ▪ No pulses
Frequency output	
Failure mode	Choose from: <ul style="list-style-type: none"> ▪ Actual value ▪ 0 Hz ▪ Defined value (f_{\max} 2 to 12 500 Hz)
Switch output	
Failure mode	Choose from: <ul style="list-style-type: none"> ▪ Current status ▪ Open ▪ Closed

Relay output

Failure mode	Choose from: <ul style="list-style-type: none"> ▪ Current status ▪ Open ▪ Closed
---------------------	-------------------------------------------------------------------------------------------------------------------

Local display

Plain text display	With information on cause and remedial measures
Backlight	Red backlighting indicates a device error.



Status signal as per NAMUR recommendation NE 107

Interface/protocol

- Via digital communication:
 - HART protocol
 - FOUNDATION Fieldbus
 - PROFIBUS PA
 - PROFIBUS DP
 - Modbus RS485
 - EtherNet/IP
 - PROFINET
- Via service interface
 - CDI-RJ45 service interface
 - WLAN interface

Plain text display	With information on cause and remedial measures
---------------------------	-------------------------------------------------



Additional information on remote operation → 81

Web server

Plain text display	With information on cause and remedial measures
---------------------------	-------------------------------------------------

Light emitting diodes (LED)

Status information	<p>Status indicated by various light emitting diodes</p> <p>The following information is displayed depending on the device version:</p> <ul style="list-style-type: none"> ▪ Supply voltage active ▪ Data transmission active ▪ Device alarm/error has occurred ▪ EtherNet/IP network available ▪ EtherNet/IP connection established ▪ PROFINET network available ▪ PROFINET connection established ▪ PROFINET blinking feature
---------------------------	---------------------------------------------------------------------------------------------------------------------------------------------------------------------------------------------------------------------------------------------------------------------------------------------------------------------------------------------------------------------------------------------------------------------------------------------------------------------------------------------------------------

Ex connection data

Safety-related values

Order code for "Output; input 1"	Output type	Safety-related values "Output; input 1"	
		26 (+)	27 (-)
Option BA	Current output 4 to 20 mA HART	$U_N = 30 V_{DC}$ $U_M = 250 V_{AC}$	
Option GA	PROFIBUS PA	$U_N = 30 V_{DC}$ $U_M = 250 V_{AC}$	
Option LA	PROFIBUS DP	$U_N = 30 V_{DC}$ $U_M = 250 V_{AC}$	
Option MA	Modbus RS485	$U_N = 30 V_{DC}$ $U_M = 250 V_{AC}$	
Option SA	FOUNDATION Fieldbus	$U_N = 30 V_{DC}$ $U_M = 250 V_{AC}$	
Option NA	EtherNet/IP	$U_N = 30 V_{DC}$ $U_M = 250 V_{AC}$	
Option RA	PROFINET	$U_N = 30 V_{DC}$ $U_M = 250 V_{AC}$	

Order code for "Output; input 2"; "Output; input 3" "Output; input 4"	Output type	Safety-related values					
		Output; input 2		Output; input 3		Output; input 4 ¹⁾	
		24 (+)	25 (-)	22 (+)	23 (-)	20 (+)	21 (-)
Option B	Current output 4 to 20 mA	$U_N = 30 V_{DC}$ $U_M = 250 V_{AC}$					
Option D	User configurable input/output	$U_N = 30 V_{DC}$ $U_M = 250 V_{AC}$					
Option E	Pulse/frequency/switch output	$U_N = 30 V_{DC}$ $U_M = 250 V_{AC}$					
Option F	Double pulse output	$U_N = 30 V_{DC}$ $U_M = 250 V_{AC}$					
Option H	Relay output	$U_N = 30 V_{DC}$ $I_N = 100 mA_{DC}/500 mA_{AC}$ $U_M = 250 V_{AC}$					

Order code for "Output; input 2"; "Output; input 3" "Output; input 4"	Output type	Safety-related values					
		Output; input 2		Output; input 3		Output; input 4 ¹⁾	
		24 (+)	25 (-)	22 (+)	23 (-)	20 (+)	21 (-)
Option I	Current input 4 to 20 mA	$U_N = 30 V_{DC}$ $U_M = 250 V_{AC}$					
Option J	Status input	$U_N = 30 V_{DC}$ $U_M = 250 V_{AC}$					

1) The order code "Output; input 4" is only available for the Proline 500 – digital transmitter.

Intrinsically safe values

Order code for "Output; input 1"	Output type	Intrinsically safe values "Output; input 1"	
		26 (+)	27 (-)
Option CA	Current output 4 to 20 mA HART Ex i	$U_i = 30 V$ $I_i = 100 mA$ $P_i = 1.25 W$ $L_i = 0$ $C_i = 0$	
Option HA	PROFIBUS PA Ex i	Ex ia ¹⁾ $U_i = 30 V$ $I_i = 570 mA$ $P_i = 8.5 W$ $L_i = 10 \mu H$ $C_i = 5 nF$	Ex ic ²⁾ $U_i = 32 V$ $I_i = 570 mA$ $P_i = 8.5 W$ $L_i = 10 \mu H$ $C_i = 5 nF$
Option TA	FOUNDATION Fieldbus Ex i	Ex ia ¹⁾ $U_i = 30 V$ $I_i = 570 mA$ $P_i = 8.5 W$ $L_i = 10 \mu H$ $C_i = 5 nF$	Ex ic ²⁾ $U_i = 32 V$ $I_i = 570 mA$ $P_i = 8.5 W$ $L_i = 10 \mu H$ $C_i = 5 nF$

1) Only available for the Zone 1; Class I, Division 1 version

2) Only available for the Zone 2; Class I, Division 2 version and only for the Proline 500 – digital transmitter

Order code for "Output; input 2"; "Output; input 3" "Output; input 4"	Output type	Intrinsically safe values or NIFW values					
		Output; input 2		Output; input 3		Output; input 4 ¹⁾	
		24 (+)	25 (-)	22 (+)	23 (-)	20 (+)	21 (-)
Option C	Current output 4 to 20 mA Ex i	$U_i = 30 V$ $I_i = 100 mA$ $P_i = 1.25 W$ $L_i = 0$ $C_i = 0$					
Option G	Pulse/frequency/switch output Ex i	$U_i = 30 V$ $I_i = 100 mA$ $P_i = 1.25 W$ $L_i = 0$ $C_i = 0$					

1) The order code "Output; input 4" is only available for the Proline 500 – digital transmitter.

Low flow cut off

The switch points for low flow cut off are user-selectable.

Galvanic isolation



The outputs are galvanically isolated from one another and from earth (PE).

Protocol-specific data

HART



Manufacturer ID	0x11
Device type ID	0x3B
HART protocol revision	7
Device description files (DTM, DD)	Information and files under: www.endress.com
HART load	Min. 250 Ω
System integration	Information on system integration: Operating Instructions →  101. <ul style="list-style-type: none"> ▪ Measured variables via HART protocol ▪ Burst Mode functionality

PROFIBUS PA

Manufacturer ID	0x11
Ident number	0x156D
Profile version	3.02
Device description files (GSD, DTM, DD)	Information and files under: <ul style="list-style-type: none"> ▪ www.endress.com ▪ www.profibus.org
Supported functions	<ul style="list-style-type: none"> ▪ Identification & Maintenance Simplest device identification on the part of the control system and nameplate ▪ PROFIBUS upload/download Reading and writing parameters is up to ten times faster with PROFIBUS upload/download ▪ Condensed status Simplest and self-explanatory diagnostic information by categorizing diagnostic messages that occur
Configuration of the device address	<ul style="list-style-type: none"> ▪ DIP switches on the I/O electronics module ▪ Local display ▪ Via operating tools (e.g. FieldCare)
Compatibility with earlier model	<p>If the device is replaced, the measuring device Promass 500 supports the compatibility of the cyclic data with previous models. It is not necessary to adjust the engineering parameters of the PROFIBUS network with the Promass 500 GSD file.</p> <p>Earlier models:</p> <ul style="list-style-type: none"> ▪ Promass 80 PROFIBUS PA <ul style="list-style-type: none"> - ID No.: 1528 (hex) - Extended GSD file: EH3x1528.gsd - Standard GSD file: EH3_1528.gsd ▪ Promass 83 PROFIBUS PA <ul style="list-style-type: none"> - ID No.: 152A (hex) - Extended GSD file: EH3x152A.gsd - Standard GSD file: EH3_152A.gsd <p> Description of the function scope of compatibility: Operating Instructions →  101.</p>
System integration	Information regarding system integration: Operating Instructions →  101. <ul style="list-style-type: none"> ▪ Cyclic data transmission ▪ Block model ▪ Description of the modules

PROFIBUS DP

Manufacturer ID	0x11
Ident number	0x156F

Profile version	3.02
Device description files (GSD, DTM, DD)	Information and files under: <ul style="list-style-type: none"> ▪ www.endress.com On the product page for the device: Documents/Software → Device drivers ▪ www.profibus.org
Supported functions	<ul style="list-style-type: none"> ▪ Identification & Maintenance Simplest device identification on the part of the control system and nameplate ▪ PROFIBUS upload/download Reading and writing parameters is up to ten times faster with PROFIBUS upload/download ▪ Condensed status Simplest and self-explanatory diagnostic information by categorizing diagnostic messages that occur
Configuration of the device address	<ul style="list-style-type: none"> ▪ DIP switches on the I/O electronics module ▪ Via operating tools (e.g. FieldCare)
Compatibility with earlier model	<p>If the device is replaced, the measuring device Promass 500 supports the compatibility of the cyclic data with previous models. It is not necessary to adjust the engineering parameters of the PROFIBUS network with the Promass 500 GSD file.</p> <p>Previous model: Promass 83 PROFIBUS DP</p> <ul style="list-style-type: none"> - ID No.: 1529 (hex) - Extended GSD file: EH3x1529.gsd - Standard GSD file: EH3_1529.gsd <p> Description of the function scope of compatibility: Operating Instructions →  101.</p>
System integration	<p>Information regarding system integration: Operating Instructions →  101.</p> <ul style="list-style-type: none"> ▪ Cyclic data transmission ▪ Block model ▪ Description of the modules

EtherNet/IP

Protocol	<ul style="list-style-type: none"> ▪ The CIP Networks Library Volume 1: Common Industrial Protocol ▪ The CIP Networks Library Volume 2: EtherNet/IP Adaptation of CIP
Communication type	<ul style="list-style-type: none"> ▪ 10Base-T ▪ 100Base-TX
Device profile	Generic device (product type: 0x2B)
Manufacturer ID	0x11
Device type ID	0x103B
Baud rates	Automatic ¹⁹ / ₁₀₀ Mbit with half-duplex and full-duplex detection
Polarity	Auto-polarity for automatic correction of crossed TxD and RxD pairs
Supported CIP connections	Max. 3 connections
Explicit connections	Max. 6 connections
I/O connections	Max. 6 connections (scanner)
Configuration options for measuring device	<ul style="list-style-type: none"> ▪ DIP switches on the electronics module for IP addressing ▪ Manufacturer-specific software (FieldCare) ▪ Add-on Profile Level 3 for Rockwell Automation control systems ▪ Web browser ▪ Electronic Data Sheet (EDS) integrated in the measuring device
Configuration of the EtherNet interface	<ul style="list-style-type: none"> ▪ Speed: 10 MBit, 100 MBit, auto (factory setting) ▪ Duplex: half-duplex, full-duplex, auto (factory setting)

Configuration of the device address	<ul style="list-style-type: none"> ▪ DIP switches on the electronics module for IP addressing (last octet) ▪ DHCP ▪ Manufacturer-specific software (FieldCare) ▪ Add-on Profile Level 3 for Rockwell Automation control systems ▪ Web browser ▪ EtherNet/IP tools, e.g. RSLinx (Rockwell Automation)
Device Level Ring (DLR)	Yes
System integration	<p>Information regarding system integration: Operating Instructions →  101.</p> <ul style="list-style-type: none"> ▪ Cyclic data transmission ▪ Block model ▪ Input and output groups

PROFINET

Protocol	"Application layer protocol for decentral device periphery and distributed automation", version 2.3
Communication type	100 MBit/s
Conformity class	Conformance Class B
Netload Class	Netload Class II
Baud rates	Automatic 100 Mbit/s with full-duplex detection
Cycle times	From 8 ms
Polarity	Auto-polarity for automatic correction of crossed TxD and RxD pairs
Media Redundancy Protocol (MRP)	Yes
Device profile	Application interface identifier 0xF600 Generic device
Manufacturer ID	0x11
Device type ID	0x843B
Device description files (GSD, DTM, DD)	<p>Information and files under:</p> <ul style="list-style-type: none"> ▪ www.endress.com On the product page for the device: Documents/Software → Device drivers ▪ www.profibus.org
Supported connections	<ul style="list-style-type: none"> ▪ 1 x AR (IO Controller AR) ▪ 1 x AR (IO-Supervisor Device AR connection allowed) ▪ 1 x Input CR (Communication Relation) ▪ 1 x Output CR (Communication Relation) ▪ 1 x Alarm CR (Communication Relation)
Configuration options for measuring device	<ul style="list-style-type: none"> ▪ DIP switches on the electronics module, for device name assignment (last part) ▪ Manufacturer-specific software (FieldCare, DeviceCare) ▪ Web browser ▪ Device master file (GSD), can be read out via the integrated Web server of the measuring device
Configuration of the device name	<ul style="list-style-type: none"> ▪ DIP switches on the electronics module, for device name assignment (last part) ▪ DCP protocol ▪ Process Device Manager (PDM) ▪ Integrated Web server





Supported functions	<ul style="list-style-type: none"> ▪ Identification & Maintenance Simple device identification via: <ul style="list-style-type: none"> – Control system – Nameplate ▪ Measured value status The process variables are communicated with a measured value status ▪ Blinking feature via the onsite display for simple device identification and assignment ▪ Device operation via operating tools (e.g. FieldCare, DeviceCare, SIMATIC PDM)
System integration	<p>Information regarding system integration: Operating Instructions →  101.</p> <ul style="list-style-type: none"> ▪ Cyclic data transmission ▪ Overview and description of the modules ▪ Status coding ▪ Startup configuration ▪ Factory setting:

FOUNDATION Fieldbus

Manufacturer ID	0x452B48 (hex)
Ident number	0x103B (hex)
Device revision	1
DD revision	Information and files under:
CFF revision	<ul style="list-style-type: none"> ▪ www.endress.com ▪ www.fieldbus.org
Interoperability Test Kit (ITK)	Version 6.2.0
ITK Test Campaign Number	Information: <ul style="list-style-type: none"> ▪ www.endress.com ▪ www.fieldbus.org
Link Master capability (LAS)	Yes
Choice of "Link Master" and "Basic Device"	Yes Factory setting: Basic Device
Node address	Factory setting: 247 (0xF7)
Supported functions	<p>The following methods are supported:</p> <ul style="list-style-type: none"> ▪ Restart ▪ ENP Restart ▪ Diagnostic ▪ Set to OOS ▪ Set to AUTO ▪ Read trend data ▪ Read event logbook
Virtual Communication Relationships (VCRs)	
Number of VCRs	44
Number of link objects in VFD	50
Permanent entries	1
Client VCRs	0
Server VCRs	10
Source VCRs	43
Sink VCRs	0
Subscriber VCRs	43
Publisher VCRs	43
Device Link Capabilities	
Slot time	4
Min. delay between PDU	8

Max. response delay	16
System integration	Information regarding system integration: Operating Instructions →  101. <ul style="list-style-type: none"> ▪ Cyclic data transmission ▪ Description of the modules ▪ Execution times ▪ Methods

Modbus RS485

Protocol	Modbus Applications Protocol Specification V1.1
Response times	<ul style="list-style-type: none"> ▪ Direct data access: typically 25 to 50 ms ▪ Auto-scan buffer (data range): typically 3 to 5 ms
Device type	Slave
Slave address range	1 to 247
Broadcast address range	0
Function codes	<ul style="list-style-type: none"> ▪ 03: Read holding register ▪ 04: Read input register ▪ 06: Write single registers ▪ 08: Diagnostics ▪ 16: Write multiple registers ▪ 23: Read/write multiple registers
Broadcast messages	Supported by the following function codes: <ul style="list-style-type: none"> ▪ 06: Write single registers ▪ 16: Write multiple registers ▪ 23: Read/write multiple registers
Supported baud rate	<ul style="list-style-type: none"> ▪ 1 200 BAUD ▪ 2 400 BAUD ▪ 4 800 BAUD ▪ 9 600 BAUD ▪ 19 200 BAUD ▪ 38 400 BAUD ▪ 57 600 BAUD ▪ 115 200 BAUD
Data transfer mode	<ul style="list-style-type: none"> ▪ ASCII ▪ RTU
Data access	Each device parameter can be accessed via Modbus RS485.  For Modbus register information
Compatibility with earlier model	If the device is replaced, the measuring device Promass 500 supports the compatibility of the Modbus registers for the process variables and the diagnostic information with the previous model Promass 83. It is not necessary to change the engineering parameters in the automation system.  Description of the function scope of compatibility: Operating Instructions →  101.
System integration	Information on system integration: Operating Instructions →  101. <ul style="list-style-type: none"> ▪ Modbus RS485 information ▪ Function codes ▪ Register information ▪ Response time ▪ Modbus data map

Power supply

Terminal assignment

Transmitter: supply voltage, input/outputs

HART

Supply voltage		Input/output 1		Input/output 2		Input/output 3		Input/output 4	
1 (+)	2 (-)	26 (+)	27 (-)	24 (+)	25 (-)	22 (+)	23 (-)	20 (+)	21 (-)
The terminal assignment depends on the specific device version ordered → 14.									

FOUNDATION Fieldbus

Supply voltage		Input/output 1		Input/output 2		Input/output 3		Input/output 4	
1 (+)	2 (-)	26 (A)	27 (B)	24 (+)	25 (-)	22 (+)	23 (-)	20 (+)	21 (-)
The terminal assignment depends on the specific device version ordered → 14.									

PROFIBUS PA

Supply voltage		Input/output 1		Input/output 2		Input/output 3		Input/output 4	
1 (+)	2 (-)	26 (B)	27 (A)	24 (+)	25 (-)	22 (+)	23 (-)	20 (+)	21 (-)
The terminal assignment depends on the specific device version ordered → 14.									

PROFIBUS DP

Supply voltage		Input/output 1		Input/output 2		Input/output 3		Input/output 4	
1 (+)	2 (-)	26 (B)	27 (A)	24 (+)	25 (-)	22 (+)	23 (-)	20 (+)	21 (-)
The terminal assignment depends on the specific device version ordered → 14.									

Modbus RS485

Supply voltage		Input/output 1		Input/output 2		Input/output 3		Input/output 4	
1 (+)	2 (-)	26 (B)	27 (A)	24 (+)	25 (-)	22 (+)	23 (-)	20 (+)	21 (-)
The terminal assignment depends on the specific device version ordered → 14.									

PROFINET

Supply voltage		Input/output 1		Input/output 2		Input/output 3		Input/output 4	
1 (+)	2 (-)	PROFINET (RJ45 connector)		24 (+)	25 (-)	22 (+)	23 (-)	20 (+)	21 (-)
The terminal assignment depends on the specific device version ordered → 14.									

EtherNet/IP

Supply voltage		Input/output 1		Input/output 2		Input/output 3		Input/output 4	
1 (+)	2 (-)	EtherNet/IP (RJ45 connector)		24 (+)	25 (-)	22 (+)	23 (-)	20 (+)	21 (-)
The terminal assignment depends on the specific device version ordered → 14.									

Transmitter and sensor connection housing: connecting cable

The sensor and transmitter, which are mounted in separate locations, are interconnected by a connecting cable. The cable is connected via the sensor connection housing and the transmitter housing.

Terminal assignment and connection of the connecting cable:

- Proline 500 – digital → 32
- Proline 500 → 32

Device plugs available

 Device plugs may not be used in hazardous areas!

Device plugs for fieldbus systems:

Order code for "Input; output 1"

- Option **SA** "FOUNDATION Fieldbus" → 29
- Option **GA** "PROFIBUS PA" → 29
- Option **RA** "PROFINET" → 29
- Option **NA** "EtherNet/IP" → 29

Device plug for connecting to the service interface:

Order code for "Accessory mounted"

option **NB**, adapter RJ45 M12 (service interface) → 31

Order code for "Input; output 1", option SA "FOUNDATION Fieldbus"

Order code for "Electrical connection"	Cable entry/connection → 33	
	2	3
M, 3, 4, 5	7/8" connector	-

Order code for "Input; output 1", option GA "PROFIBUS PA"

Order code for "Electrical connection"	Cable entry/connection → 33	
	2	3
L, N, P, U	Connector M12 × 1	-

Order code for "Input; output 1", option RA "PROFINET"

Order code for "Electrical connection"	Cable entry/connection → 33	
	2	3
L, N, P, U	Connector M12 × 1	-
R ^{1) 2)} , S ^{1) 2)} , T ^{1) 2)} , V ^{1) 2)}	Connector M12 × 1	Connector M12 × 1

- 1) Cannot be combined with an external WLAN antenna (order code for "Enclosed accessories", option P8) of an RJ45 M12 adapter for the service interface (order code for "Accessories mounted", option NB) or of the remote display and operating module DKX001.
- 2) Suitable for integrating the device in a ring topology.

Order code for "Input; output 1", option NA "EtherNet/IP"

Order code for "Electrical connection"	Cable entry/connection → 33	
	2	3
L, N, P, U	Connector M12 × 1	-
R ^{1) 2)} , S ^{1) 2)} , T ^{1) 2)} , V ^{1) 2)}	Connector M12 × 1	Connector M12 × 1

- 1) Cannot be combined with an external WLAN antenna (order code for "Enclosed accessories", option P8) of an RJ45 M12 adapter for the service interface (order code for "Accessories mounted", option NB) or of the remote display and operating module DKX001
- 2) Suitable for integrating the device in a ring topology.

Order code for "Accessory mounted", option NB "Adapter RJ45 M12 (service interface)"

Order code "Accessory mounted"	Cable entry/coupling → 33	
	Cable entry 2	Cable entry 3
NB	Plug M12 × 1	-

Pin assignment, device plug

FOUNDATION Fieldbus

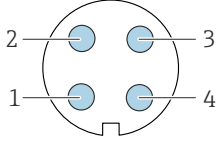
	Pin		Assignment	Coding A	Plug/socket Plug
	1	+	Signal +		
	2	-	Signal -		
	3		Grounding		
	4		Not assigned		

PROFIBUS PA

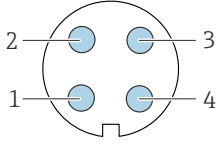
	Pin		Assignment	Coding A	Plug/socket Plug
	1	+	PROFIBUS PA +		
	2		Grounding		
	3	-	PROFIBUS PA -		
	4		Not assigned		

PROFINET

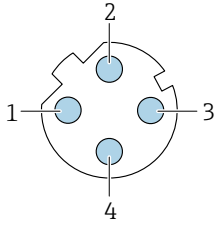
	Pin		Assignment	Coding D	Plug/socket Socket
	1	+	TD +		
	2	+	RD +		
	3	-	TD -		
	4	-	RD -		

- i** Recommended plug:
- Binder, series 763, part no. 99 3729 810 04
 - Phoenix, part no. 1543223 SACC-M12MSD-4Q
 - When using the device in a hazardous location, use a suitably certified plug.

EtherNet/IP

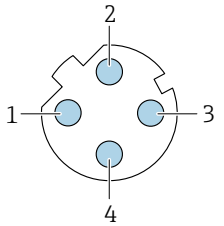
	Pin		Assignment	Coding D	Plug/socket Socket
	1	+	Tx		
	2	+	Rx		
	3	-	Tx		
	4	-	Rx		

- i** Recommended plug:
- Binder, series 763, part no. 99 3729 810 04
 - Phoenix, part no. 1543223 SACC-M12MSD-4Q
 - When using the device in a hazardous location, use a suitably certified plug.

Service interface

Order code for "Accessories mounted", option **NB**: Adapter RJ45 M12 (service interface)

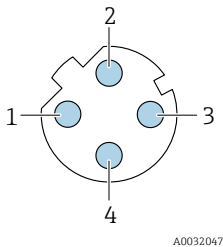
 <p style="text-align: right; font-size: small;">A0032047</p>	Pin		Assignment	
	1	+	Tx	
	2	+	Rx	
	3	-	Tx	
	4	-	Rx	
Coding		Plug/socket		
D		Socket		



Recommended plug:

- Binder, series 763, part no. 99 3729 810 04
- Phoenix, part no. 1543223 SACC-M12MSD-4Q
- When using the device in a hazardous location, use a suitably certified plug.

Supply voltage

Order code for "Power supply"	terminal voltage		Frequency range
Option D	DC24 V	±20%	-
Option E	AC100 to 240 V	-15...+10%	50/60 Hz
Option I	DC24 V	±20%	-
	AC100 to 240 V	-15...+10%	50/60 Hz

Power consumption

Transmitter

Max. 10 W (active power)

switch-on current	Max. 36 A (as per NAMUR Recommendation NE21)
--------------------------	----------------------------------------------

Current consumption

Transmitter

- Max. 400 mA (24 V)
- Max. 200 mA (110 V, 50/60 Hz; 230 V, 50/60 Hz)

Power supply failure

- Totalizers stop at the last value measured.
- Depending on the device version, the configuration is retained in the device memory or in the pluggable data memory (HistoROM DAT).
- Error messages (incl. total operated hours) are stored.

Electrical connection

Connection of connecting cable: Proline 500 – digital

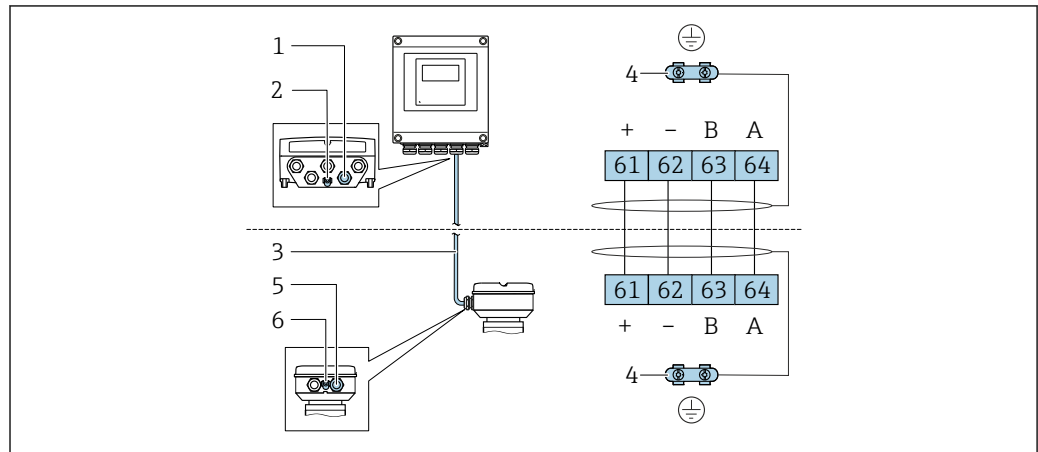

A0028198

- 1 Cable entry for cable on transmitter housing
- 2 Protective ground (PE)
- 3 Connecting cable ISEM communication
- 4 Grounding via ground connection; on device plug versions grounding is through the plug itself
- 5 Cable entry for cable or connection of device plug on sensor connection housing
- 6 Protective ground (PE)

Depending on the device version of the sensor connection housing, the connecting cable is connected via terminals or device plugs.

Sensor connection housing Order code for "Housing"	Connection to sensor connection housing via	Connection to transmitter housing via
Option A: aluminum coated	Terminals	Terminals
Option B: stainless	Terminals	Terminals
Option C ultra-compact, hygienic, stainless	Device plug	Terminals

Pin assignment, device plug

Device plugs are only available for device version, order code for "Housing":

Option C ultra-compact, hygienic, stainless

For connection to sensor connection housing.

	Pin	Color ¹⁾	Assignment		Connection to terminal
	1	Brown	+	Supply voltage	
2	White	A	ISEM communication		64
3	Blue	B			
4	Black	-	Supply voltage		63
5	-		-		62
Coding			Plug/socket		
A			Plug		

1) Cable colors of connecting cable

A connecting cable with a device plug is optionally available.

Connection of the connecting cable: Proline 500



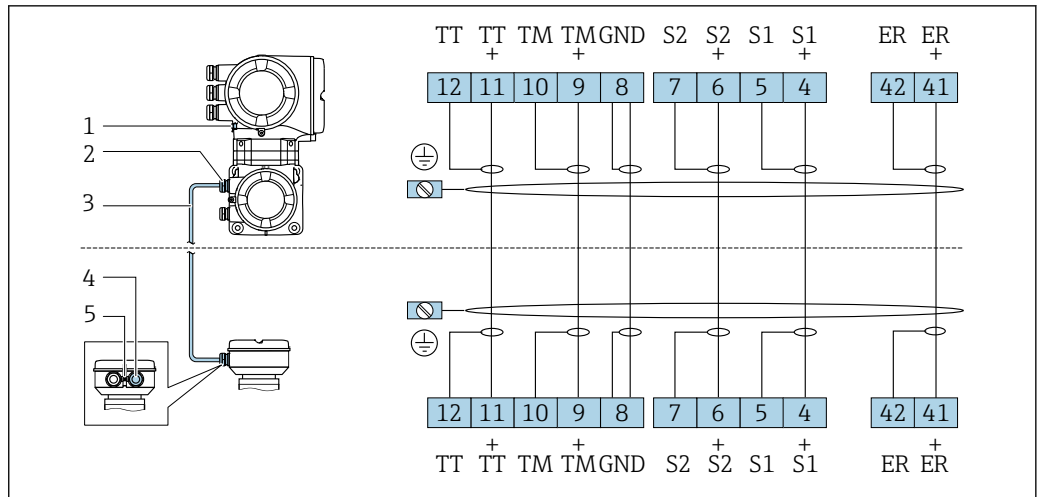

The connecting cable is connected via terminals.



A0028197

- 1 Protective ground (PE)
- 2 Cable entry for connecting cable on transmitter connection housing
- 3 Connecting cable
- 4 Cable entry for connecting cable on sensor connection housing
- 5 Protective ground (PE)

Connecting the transmitter

-  Terminal assignment →  28
-  Device plug pin assignment →  30

Connecting the Proline 500 – digital transmitter

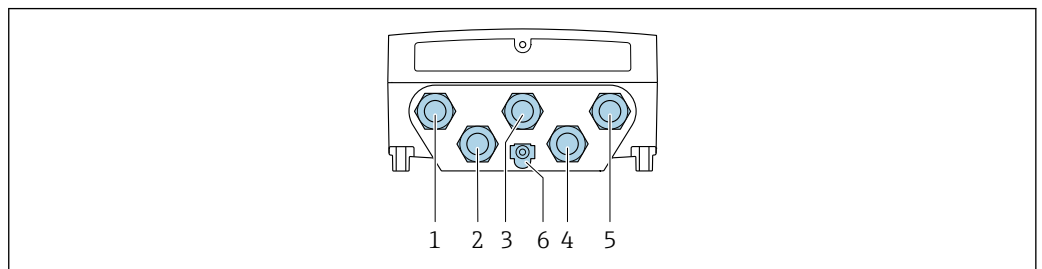



A0028200

- 1 Terminal connection for supply voltage
- 2 Terminal connection for signal transmission, input/output
- 3 Terminal connection for signal transmission, input/output
- 4 Terminal connection for connecting cable between sensor and transmitter
- 5 Terminal connection for signal transmission, input/output or terminal for network connection (DHCP client) via service interface (CDI-RJ45); optional: terminal connection for external WLAN antenna
- 6 Protective ground (PE)

-  An adapter for RJ45 and the M12 plug is optionally available:
Order code for "Accessories", option **NB**: "Adapter RJ45 M12 (service interface)"

The adapter connects the service interface (CDI-RJ45) to an M12 connector mounted in the cable entry. Therefore the connection to the service interface can be established via an M12 connector without opening the device.

-  Network connection (DHCP client) via service interface (CDI-RJ45) →  86

Connecting the Proline 500 transmitter

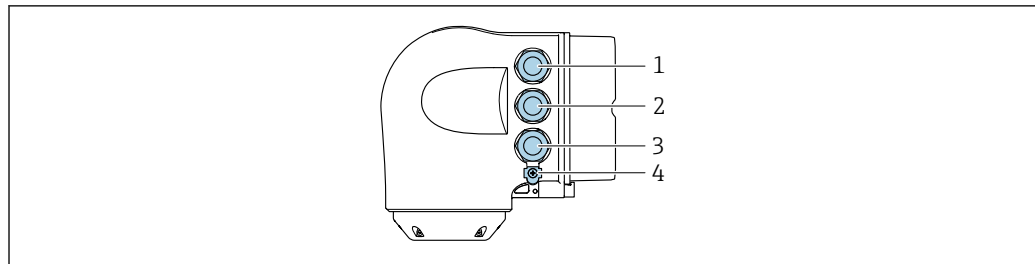

A0026781

- 1 Terminal connection for supply voltage
- 2 Terminal connection for signal transmission, input/output
- 3 Terminal connection for signal transmission, input/output or terminal for network connection (DHCP client) via service interface (CDI-RJ45); optional: terminal connection for external WLAN antenna
- 4 Protective ground (PE)

i An adapter for RJ45 and the M12 plug is optionally available:
Order code for "Accessories", option **NB**: "Adapter RJ45 M12 (service interface)"

The adapter connects the service interface (CDI-RJ45) to an M12 connector mounted in the cable entry. Therefore the connection to the service interface can be established via an M12 connector without opening the device.

i Network connection (DHCP client) via service interface (CDI-RJ45) → 86

Connecting in a ring topology

Device versions with EtherNet/IP and PROFINET communication protocols can be integrated into a ring topology. The device is integrated via the terminal connection for signal transmission (output 1) and the connection to the service interface (CDI-RJ45).

i Integrating the transmitter into a ring topology:

- EtherNet/IP → 84
- PROFINET → 85

Transmitter: Proline 500 – digital

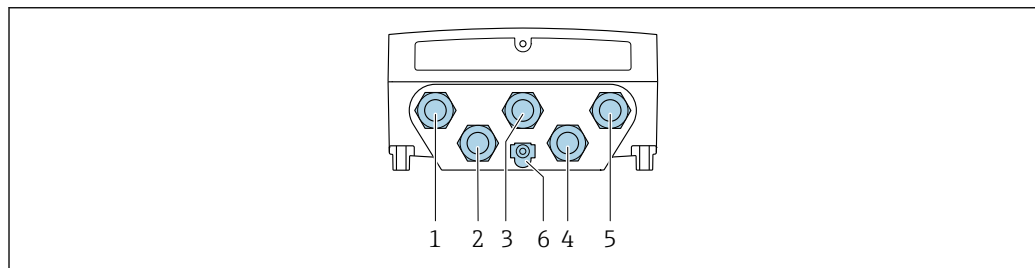

A0028200

- 1 Terminal connection for supply voltage
- 2 Terminal connection for signal transmission, input/output
- 3 Terminal connection for signal transmission: PROFINET or EtherNet/IP (RJ45 connector)
- 4 Terminal connection for connecting cable between sensor and transmitter
- 5 Terminal connection to service interface (CDI-RJ45)
- 6 Protective ground (PE)

Transmitter: Proline 500

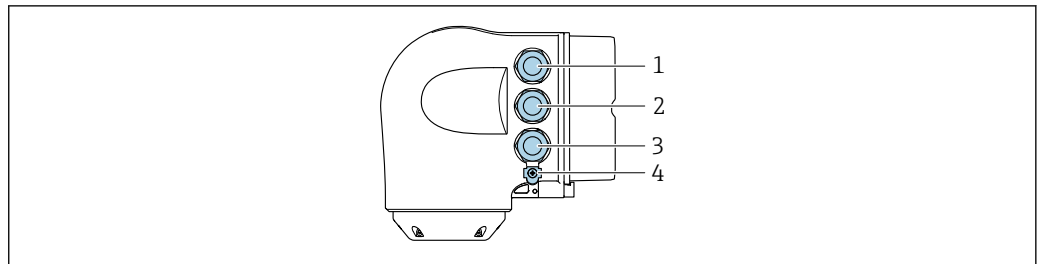

A0026781

- 1 Terminal connection for supply voltage
- 2 Terminal connection for signal transmission: PROFINET or EtherNet/IP (RJ45 connector)
- 3 Terminal connection to service interface (CDI-RJ45)
- 4 Protective ground (PE)

i If the device has additional inputs/outputs, these are routed in parallel via the cable entry for connection to the service interface (CDI-RJ45).

Connection examples

Current output 4 to 20 mA HART

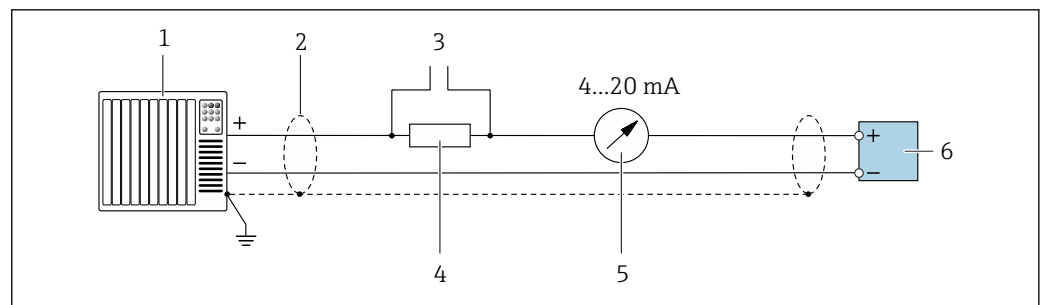

A0029055

2 Connection example for 4 to 20 mA HART current output (active)

- 1 Automation system with current input (e.g. PLC)
- 2 Cable shield: the cable shield must be grounded at both ends to comply with EMC requirements; observe cable specifications → 43
- 3 Connection for HART operating devices → 81
- 4 Resistor for HART communication ($\geq 250 \Omega$): observe maximum load → 15
- 5 Analog display unit: observe maximum load → 15
- 6 Transmitter

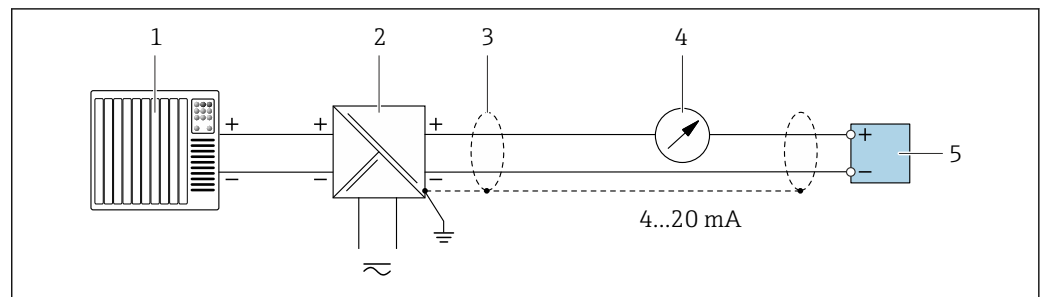

A0028762

3 Connection example for 4 to 20 mA HART current output (passive)

- 1 Automation system with current input (e.g. PLC)
- 2 Power supply
- 3 Cable shield: the cable shield must be grounded at both ends to comply with EMC requirements; observe cable specifications → 43
- 4 Analog display unit: observe maximum load → 15
- 5 Transmitter

HART input

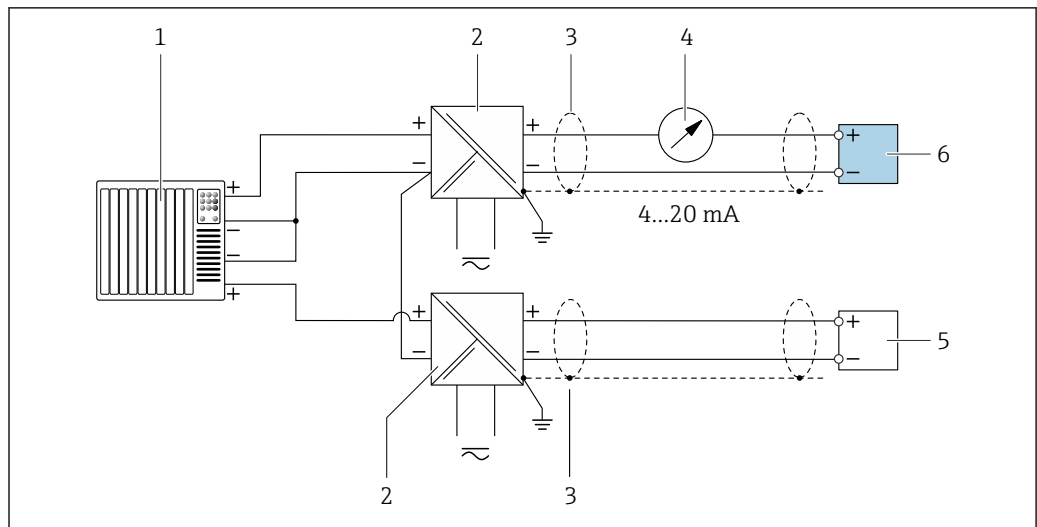

A0028763

4 Connection example for HART input with a common negative (passive)

- 1 Automation system with HART output (e.g. PLC)
- 2 Active barrier for power supply (e.g. RN221N)
- 3 Cable shield: the cable shield must be grounded at both ends to comply with EMC requirements; observe cable specifications
- 4 Analog display unit: observe maximum load
- 5 Pressure transmitter (e.g. Cerabar M, Cerabar S): see requirements
- 6 Transmitter

PROFIBUS PA

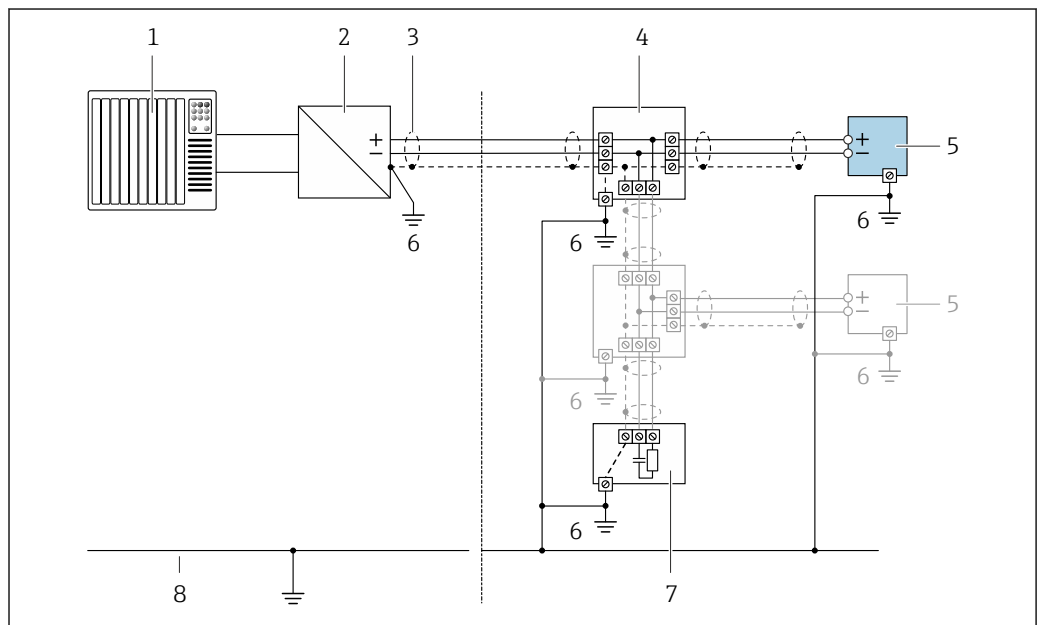

A0028768

5 Connection example for PROFIBUS PA

- 1 Control system (e.g. PLC)
- 2 PROFIBUS PA segment coupler
- 3 Cable shield: the cable shield must be grounded at both ends to comply with EMC requirements; observe cable specifications
- 4 T-box
- 5 Measuring device
- 6 Local grounding
- 7 Bus terminator
- 8 Potential matching line

PROFIBUS DP

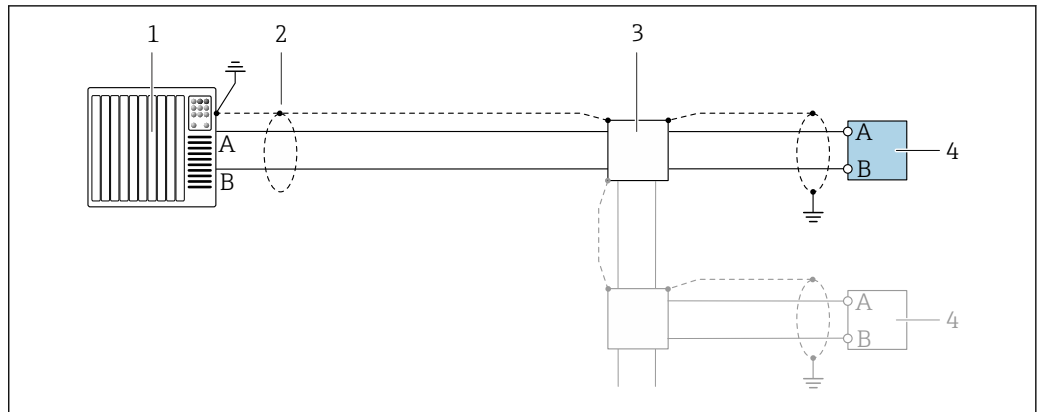

A0028765

6 Connection example for PROFIBUS DP, non-hazardous area and Zone 2/Div. 2

- 1 Control system (e.g. PLC)
- 2 Cable shield: the cable shield must be grounded at both ends to comply with EMC requirements; observe cable specifications
- 3 Distribution box
- 4 Transmitter

i If baud rates > 1.5 MBaud an EMC cable entry must be used and the cable shield must continue as far as the terminal wherever possible.

EtherNet/IP

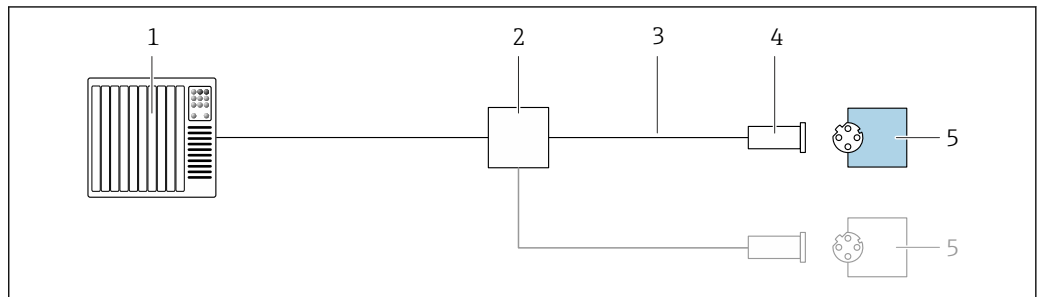

A0028767

7 Connection example for EtherNet/IP

- 1 Control system (e.g. PLC)
- 2 Ethernet switch
- 3 Observe cable specifications
- 4 Device plug
- 5 Transmitter

EtherNet/IP: DLR (Device Level Ring)

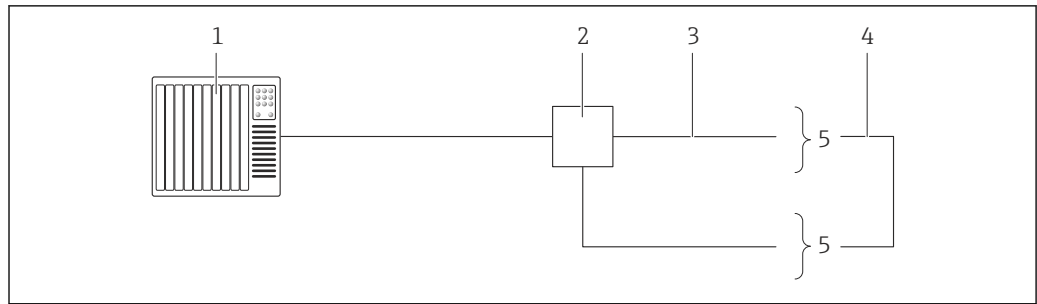

A0027544

- 1 Control system (e.g. PLC)
- 2 Ethernet switch
- 3 Observe cable specifications → 43
- 4 Connecting cable between the two transmitters
- 5 Transmitter

PROFINET

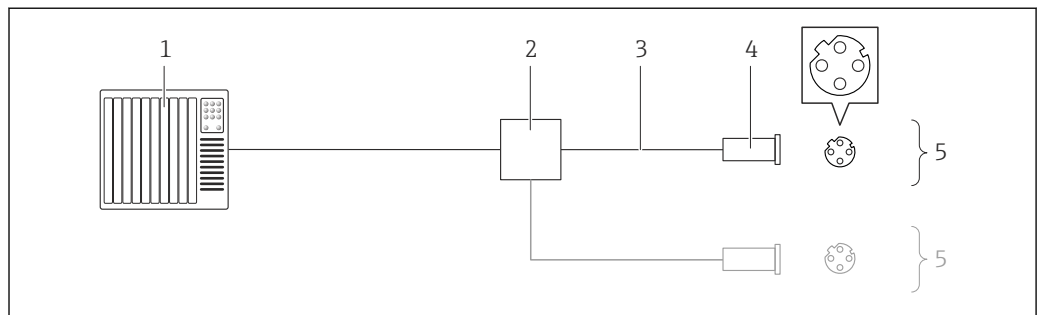

A0016805

8 Connection example for PROFINET

- 1 Control system (e.g. PLC)
- 2 Ethernet switch
- 3 Observe cable specifications
- 4 Device plug
- 5 Transmitter

PROFINET: MRP (Media Redundancy Protocol)

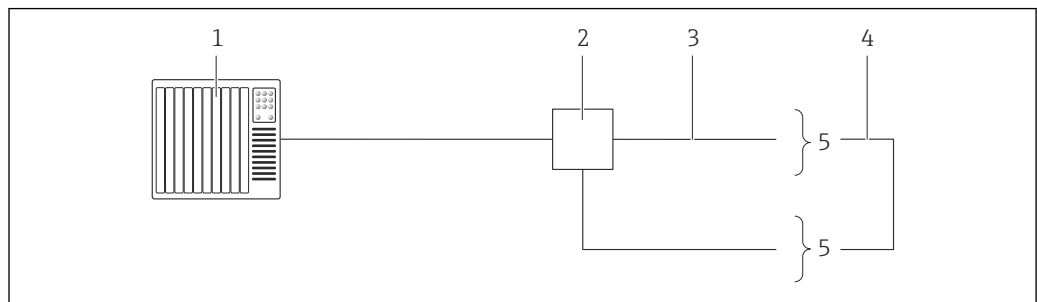

A0027544

- 1 Control system (e.g. PLC)
- 2 Ethernet switch
- 3 Observe cable specifications → 43
- 4 Connecting cable between the two transmitters
- 5 Transmitter

FOUNDATION Fieldbus

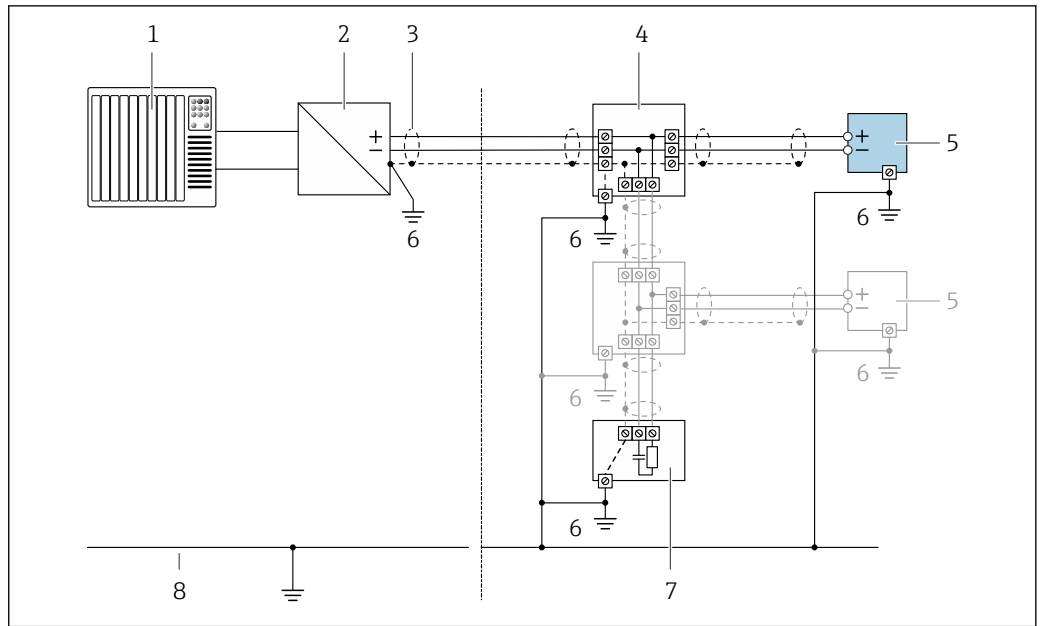

A0028768

9 Connection example for FOUNDATION Fieldbus

- 1 Control system (e.g. PLC)
- 2 Power Conditioner (FOUNDATION Fieldbus)
- 3 Cable shield: the cable shield must be grounded at both ends to comply with EMC requirements; observe cable specifications
- 4 T-box
- 5 Measuring device
- 6 Local grounding
- 7 Bus terminator
- 8 Potential matching line

Modbus RS485

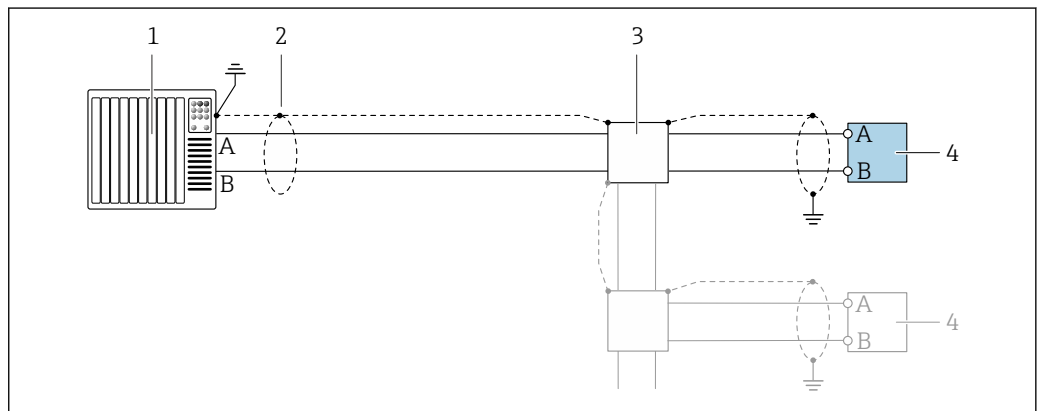

A0028765

10 Connection example for Modbus RS485, non-hazardous area and Zone 2; Class I, Division 2

- 1 Control system (e.g. PLC)
- 2 Cable shield: the cable shield must be grounded at both ends to comply with EMC requirements; observe cable specifications
- 3 Distribution box
- 4 Transmitter

Current output 4-20 mA

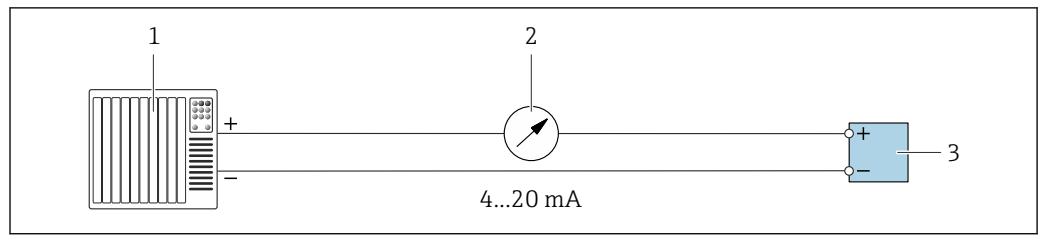

A0028758

11 Connection example for 4-20 mA current output (active)

- 1 Automation system with current input (e.g. PLC)
- 2 Analog display unit: observe maximum load
- 3 Transmitter

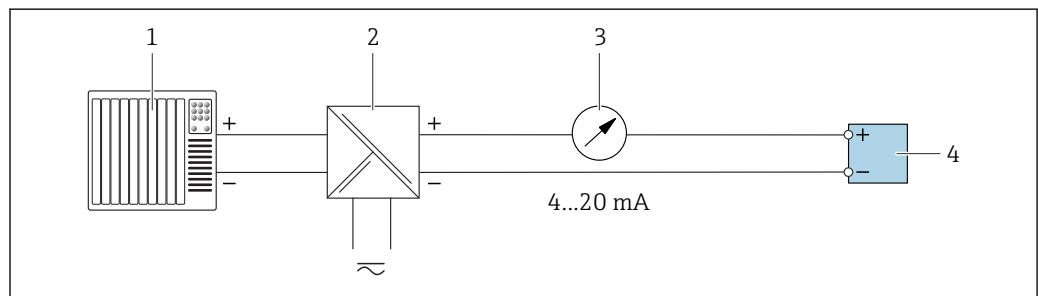

A0028759

12 Connection example for 4-20 mA current output (passive)

- 1 Automation system with current input (e.g. PLC)
- 2 Active barrier for power supply (e.g. RN221N)
- 3 Analog display unit: observe maximum load
- 4 Transmitter

Pulse/frequency output

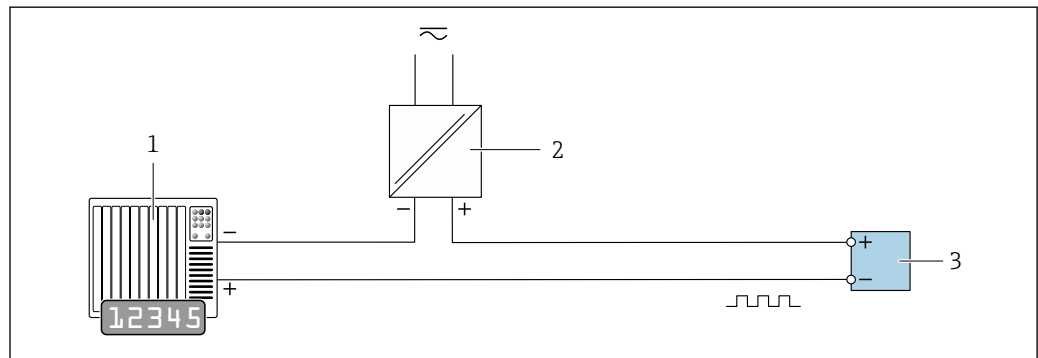

A0028761

13 Connection example for pulse/frequency output (passive)

- 1 Automation system with pulse/frequency input (e.g. PLC)
- 2 Power supply
- 3 Transmitter: Observe input values → 16

Switch output

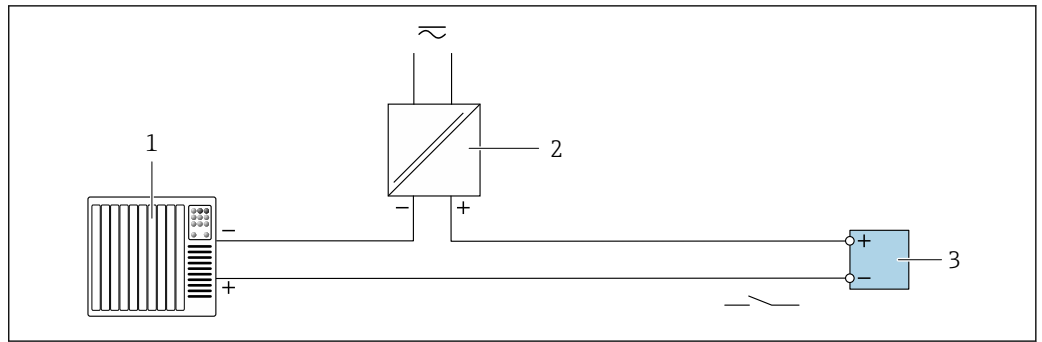

A0028760

14 Connection example for switch output (passive)

- 1 Automation system with switch input (e.g. PLC)
- 2 Power supply
- 3 Transmitter: Observe input values → 16

Double pulse output

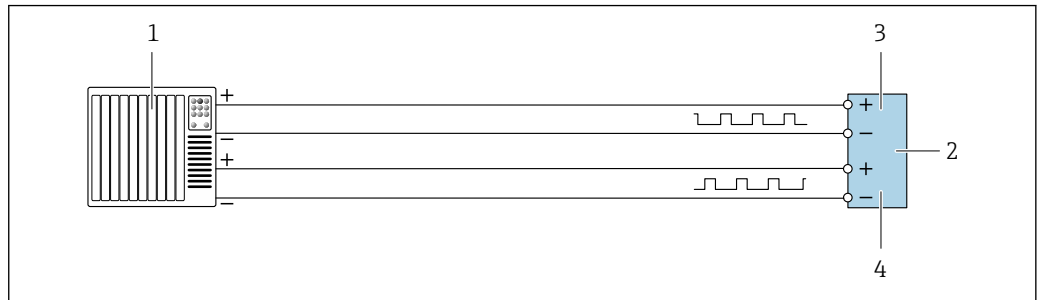

A0029280

15 Connection example for double pulse output (active)

- 1 Automation system with double pulse input (e.g. PLC)
- 2 Transmitter: Observe input values → 18
- 3 Double pulse output
- 4 Double pulse output (slave), phase-shifted

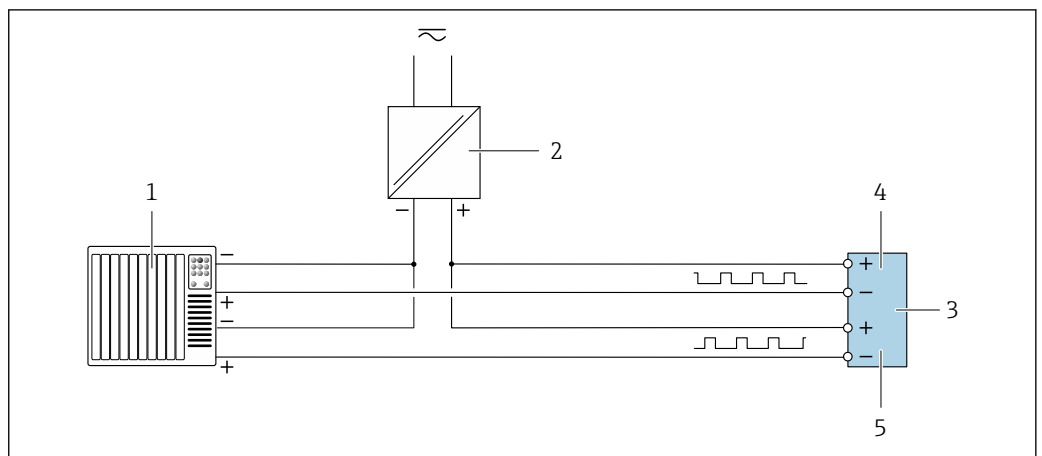

A0029279

16 Connection example for double pulse output (passive)

- 1 Automation system with double pulse input (e.g. PLC)
- 2 Power supply
- 3 Transmitter: Observe input values → 18
- 4 Double pulse output
- 5 Double pulse output (slave), phase-shifted

Relay output

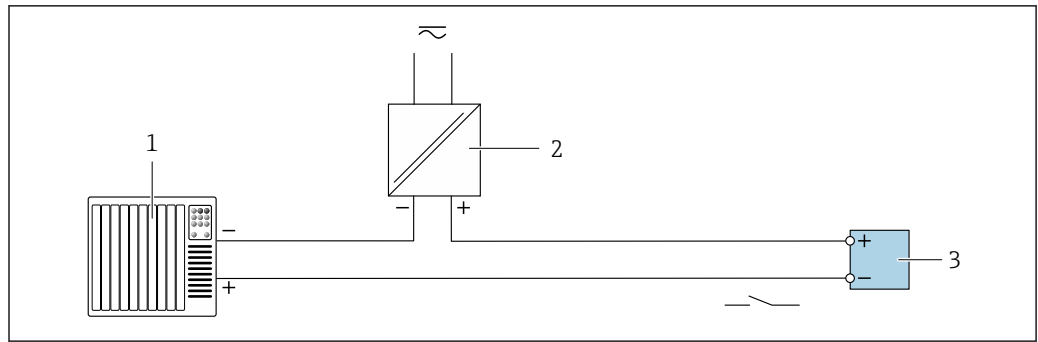

A0028760

17 Connection example for relay output (passive)

- 1 Automation system with relay input (e.g. PLC)
- 2 Power supply
- 3 Transmitter: Observe input values → 18

Current input

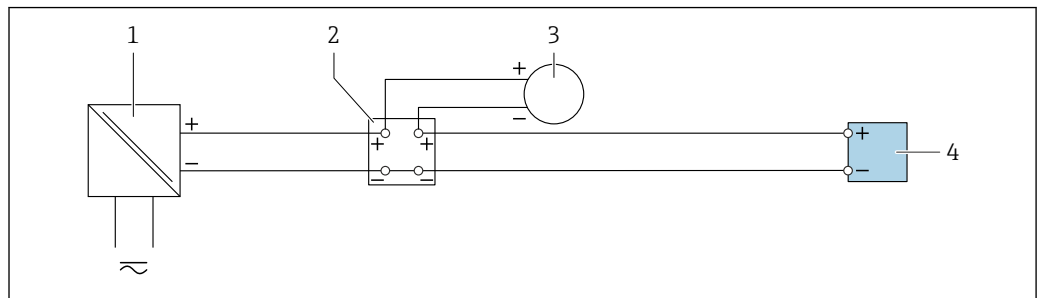

A0028915

18 Connection example for 4 to 20 mA current input

- 1 Power supply
- 2 Terminal box
- 3 External measuring device (for reading in pressure or temperature, for instance)
- 4 Transmitter

Status input

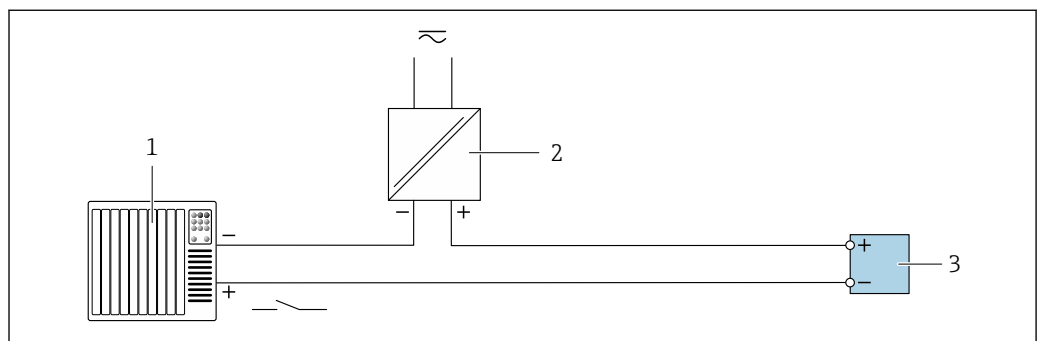

A0028764

19 Connection example for status input

- 1 Automation system with status output (e.g. PLC)
- 2 Power supply
- 3 Transmitter

Potential equalization

Requirements

No special measures for potential equalization are required.

Please consider the following to ensure correct measurement:

- Same electrical potential for the fluid and sensor
- Company-internal grounding concepts

terminals

Spring-loaded terminals: Suitable for strands and strands with ferrules.
 Conductor cross-section 0.2 to 2.5 mm² (24 to 12 AWG).

Cable entries

- Cable gland: M20 × 1.5 with cable Ø 6 to 12 mm (0.24 to 0.47 in)
- Thread for cable entry:
 - NPT ½"
 - G ½"
 - M20
- Device plug for digital communication: M12
 Only available for certain device versions →  29.
- Device plug for connecting cable: M12
 A device plug is always used for the device version with the order code for "Sensor connection housing", option C "Ultra-compact, hygienic, stainless".

Cable specification

Permitted temperature range

- The installation guidelines that apply in the country of installation must be observed.
- The cables must be suitable for the minimum and maximum temperatures to be expected.

Power supply cable

Standard installation cable is sufficient.

Protective ground cable

Cable ≥2.08 mm² (14 AWG)

The grounding impedance must be less than 1 Ω.

Signal cable

Current output 4 to 20 mA HART

A shielded cable is recommended. Observe grounding concept of the plant.

PROFIBUS PA

Twisted, shielded two-wire cable. Cable type A is recommended .



For further information on planning and installing PROFIBUS networks see:

- Operating Instructions "PROFIBUS DP/PA: Guidelines for planning and commissioning" (BA00034S)
- PNO Directive 2.092 "PROFIBUS PA User and Installation Guideline"
- IEC 61158-2 (MBP)

PROFIBUS DP

The IEC 61158 standard specifies two types of cable (A and B) for the bus line which can be used for every transmission rate. Cable type A is recommended.

Cable type	A
Characteristic impedance	135 to 165 Ω at a measuring frequency of 3 to 20 MHz
Cable capacitance	< 30 pF/m
Wire cross-section	> 0.34 mm ² (22 AWG)
Cable type	Twisted pairs
Loop resistance	≤110 Ω/km

Signal damping	Max. 9 dB over the entire length of the cable cross-section
Shield	Copper braided shielding or braided shielding with foil shield. When grounding the cable shield, observe the grounding concept of the plant.



For further information on planning and installing PROFIBUS networks see:

- Operating Instructions "PROFIBUS DP/PA: Guidelines for planning and commissioning" (BA00034S)
- PNO Directive 2.092 "PROFIBUS PA User and Installation Guideline"
- IEC 61158-2 (MBP)

EtherNet/IP

The standard ANSI/TIA/EIA-568-B.2 Annex specifies CAT 5 as the minimum category for a cable used for EtherNet/IP. CAT 5e and CAT 6 are recommended.



For more information on planning and installing EtherNet/IP networks, please refer to the "Media Planning and Installation Manual. EtherNet/IP" of ODVA Organization

PROFINET

Standard IEC 61156-6 specifies CAT 5 as the minimum category for a cable used for PROFINET. CAT 5e and CAT 6 are recommended.



For more information on planning and installing PROFINET networks, see: "PROFINET Cabling and Interconnection Technology", Guideline for PROFINET

FOUNDATION Fieldbus

Twisted, shielded two-wire cable.



For further information on planning and installing FOUNDATION Fieldbus networks see:

- Operating Instructions for "FOUNDATION Fieldbus Overview" (BA00013S)
- FOUNDATION Fieldbus Guideline
- IEC 61158-2 (MBP)

Modbus RS485

The EIA/TIA-485 standard specifies two types of cable (A and B) for the bus line which can be used for every transmission rate. Cable type A is recommended.

Cable type	A
Characteristic impedance	135 to 165 Ω at a measuring frequency of 3 to 20 MHz
Cable capacitance	< 30 pF/m
Wire cross-section	> 0.34 mm ² (22 AWG)
Cable type	Twisted pairs
Loop resistance	\leq 110 Ω /km
Signal damping	Max. 9 dB over the entire length of the cable cross-section
Shield	Copper braided shielding or braided shielding with foil shield. When grounding the cable shield, observe the grounding concept of the plant.

Current output 0/4 to 20 mA

Standard installation cable is sufficient.

Pulse/frequency/switch output

Standard installation cable is sufficient.

Double pulse output

Standard installation cable is sufficient.

Relay output

Standard installation cable is sufficient.

Current input 0/4 to 20 mA

Standard installation cable is sufficient.

Status input

Standard installation cable is sufficient.

Choice of connecting cable between the transmitter and sensor

Depends on the type of transmitter and the installation zones

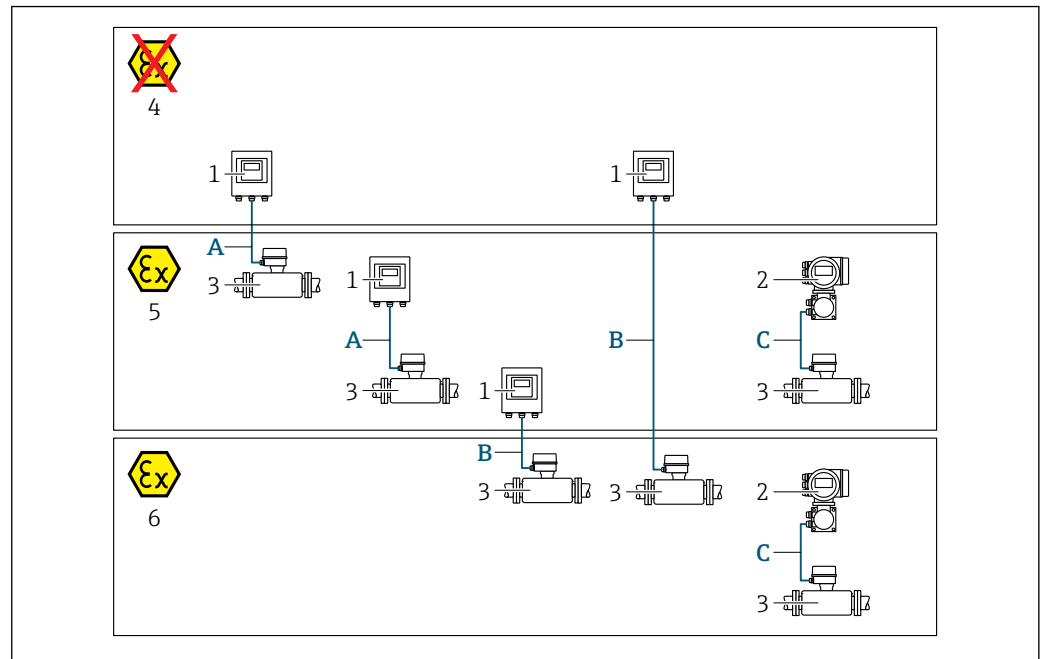

A0032476

- 1 Proline 500 digital transmitter
- 2 Proline 500 transmitter
- 3 Sensor Promass
- 4 Non-hazardous area
- 5 Hazardous area: Zone 2; Class I, Division 2
- 6 Hazardous area: Zone 1; Class I, Division 1
- A Standard cable to 500 digital transmitter → 45
Transmitter installed in the non-hazardous area or hazardous area: Zone 2; Class I, Division 2 / sensor installed in the hazardous area: Zone 2; Class I, Division 2
- B Standard cable to 500 digital transmitter → 46
Transmitter installed in the hazardous area: Zone 2; Class I, Division 2 / sensor installed in the hazardous area: Zone 1; Class I, Division 1
- C Signal cable to 500 transmitter → 48
Transmitter and sensor installed in the hazardous area: Zone 2; Class I, Division 2 oder Zone 1; Class I, Division 1

A: Connecting cable between sensor and transmitter: Proline 500 – digital

Standard cable

A standard cable with the following specifications can be used as the connecting cable.

Design	4 cores (2 pairs); uninsulated stranded CU wires; pair-stranded with common shield
Shielding	Tin-plated copper-braid, optical cover ≥ 85 %
Loop resistance	Power supply line (+, -): maximum 10 Ω
Cable length	Maximum 300 m (1000 ft), see the following table.

Cross-section	Cable length [max.]
0.34 mm ² (AWG 22)	80 m (270 ft)
0.50 mm ² (AWG 20)	120 m (400 ft)
0.75 mm ² (AWG 18)	180 m (600 ft)
1.00 mm ² (AWG 17)	240 m (800 ft)
1.50 mm ² (AWG 15)	300 m (1 000 ft)

Optionally available connecting cable

Design	2 × 2 × 0.34 mm ² (AWG 22) PVC cable ¹⁾ with common shield (2 pairs, uninsulated stranded CU wires; pair-stranded)
Flame resistance	According to DIN EN 60332-1-2
Oil-resistance	According to DIN EN 60811-2-1
Shielding	Tin-plated copper-braid, optical cover ≥ 85 %
Operating temperature	When mounted in a fixed position: -50 to +105 °C (-58 to +221 °F); when cable can move freely: -25 to +105 °C (-13 to +221 °F)
Available cable length	Fixed: 20 m (65 ft); variable: up to maximum 50 m (165 ft)

1) UV radiation can impair the cable outer sheath. Protect the cable from direct sunshine where possible.

B: Connecting cable between sensor and transmitter: Proline 500 - digital

Standard cable

A standard cable with the following specifications can be used as the connecting cable.

Design	4, 6, 8 cores (2, 3, 4 pairs); uninsulated stranded CU wires; pair-stranded with common shield
Shielding	Tin-plated copper-braid, optical cover ≥ 85 %
Capacitance C	Maximum 760 nF IIC, maximum 4.2 µF IIB
Inductance L	Maximum 26 µH IIC, maximum 104 µH IIB
Inductance/resistance ratio (L/R)	Maximum 8.9 µH/Ω IIC, maximum 35.6 µH/Ω IIB (e.g. in accordance with IEC 60079-25)
Loop resistance	Power supply line (+, -): maximum 5 Ω
Cable length	Maximum 150 m (500 ft), see the following table.

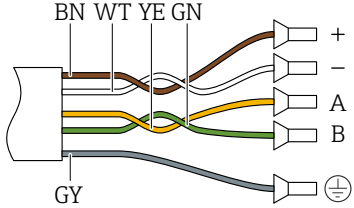
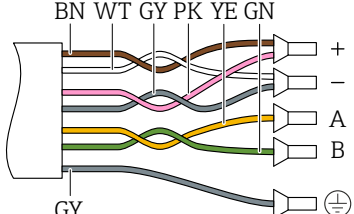
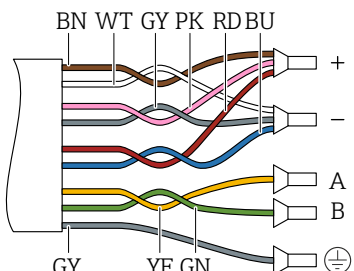
Cross-section	Cable length [max.]	Termination
2 x 2 x 0.50 mm ² (AWG 20)	50 m (165 ft)	2 x 2 x 0.50 mm ² (AWG 20)  <ul style="list-style-type: none"> ■ +, - = 0.5 mm² ■ A, B = 0.5 mm²
3 x 2 x 0.50 mm ² (AWG 20)	100 m (330 ft)	3 x 2 x 0.50 mm ² (AWG 20)  <ul style="list-style-type: none"> ■ +, - = 1.0 mm² ■ A, B = 0.5 mm²
4 x 2 x 0.50 mm ² (AWG 20)	150 m (500 ft)	4 x 2 x 0.50 mm ² (AWG 20)  <ul style="list-style-type: none"> ■ +, - = 1.5 mm² ■ A, B = 0.5 mm²

Optionally available connecting cable

Connecting cable for	Zone 1; Class I, Division 1
Standard cable	2 × 2 × 0.5 mm ² (AWG 20) PVC cable ¹⁾ with common shield (2 pairs, pair-stranded)
Flame resistance	According to DIN EN 60332-1-2
Oil-resistance	According to DIN EN 60811-2-1
Shielding	Tin-plated copper-braid, optical cover ≥ 85 %
Operating temperature	When mounted in a fixed position: -50 to +105 °C (-58 to +221 °F); when cable can move freely: -25 to +105 °C (-13 to +221 °F)
Available cable length	Fixed: 20 m (65 ft); variable: up to maximum 50 m (165 ft)

1) UV radiation can impair the cable outer sheath. Protect the cable from direct sunshine where possible.

C: Connecting cable between sensor and transmitter: Proline 500

Standard cable	6 × 0.38 mm ² PVC cable ¹⁾ with common shield and individually shielded cores
Conductor resistance	≤50 Ω/km (0.015 Ω/ft)
Capacitance: core/shield	≤420 pF/m (128 pF/ft)
Cable length (max.)	20 m (65 ft)
Cable lengths (available for order)	5 m (15 ft), 10 m (32 ft), 20 m (65 ft)
Operating temperature	max. 105 °C (221 °F)

1) UV radiation can impair the cable outer sheath. Protect the cable from direct sunshine where possible.

Performance characteristics

Reference operating conditions

- Error limits based on ISO 11631
- Water with +15 to +45 °C (+59 to +113 °F) at 2 to 6 bar (29 to 87 psi)
- Specifications as per calibration protocol
- Accuracy based on accredited calibration rigs that are traced to ISO 17025.



To obtain measured errors, use the *Applicator* sizing tool → 100

Maximum measured error

o.r. = of reading; 1 g/cm³ = 1 kg/l; T = medium temperature

Base accuracy



Design fundamentals → 51

Mass flow and volume flow (liquids)

±0.10 % o.r.

Mass flow (gases)

±0.50 % o.r. (tantalum)

Density (liquids)

Under reference operating conditions [g/cm ³]	Standard density calibration ¹⁾ [g/cm ³]	Wide-range Density specification ^{2) 3)} [g/cm ³]
±0.0005	±0.02	±0.002

- 1) Valid over the entire temperature and density range
- 2) Valid range for special density calibration: 0 to 2 g/cm³, +10 to +80 °C (+50 to +176 °F)
- 3) Order code for "Application package", option EE "Special density"

Temperature

±0.5 °C ± 0.005 · T °C (±0.9 °F ± 0.003 · (T - 32) °F)

Zero point stability

DN		Zero point stability	
[mm]	[in]	[kg/h]	[lb/min]
8	$\frac{3}{8}$	0.40	0.015
15	$\frac{1}{2}$	0.65	0.024
25	1	1.80	0.066
40	$1\frac{1}{2}$	9.00	0.331
50	2	14.00	0.514

Flow values

Flow values as turndown parameter depending on nominal diameter.

SI units

DN	1:1	1:10	1:20	1:50	1:100	1:500
[mm]	[kg/h]	[kg/h]	[kg/h]	[kg/h]	[kg/h]	[kg/h]
8	2 000	200	100	40	20	4
15	6 500	650	325	130	65	13
25	18 000	1800	900	360	180	36
40	45 000	4 500	2 250	900	450	90
50	70 000	7 000	3 500	1 400	700	140

US units

DN	1:1	1:10	1:20	1:50	1:100	1:500
[inch]	[lb/min]	[lb/min]	[lb/min]	[lb/min]	[lb/min]	[lb/min]
$\frac{3}{8}$	73.50	7.350	3.675	1.470	0.735	0.147
$\frac{1}{2}$	238.9	23.89	11.95	4.778	2.389	0.478
1	661.5	66.15	33.08	13.23	6.615	1.323
$1\frac{1}{2}$	1 654	165.4	82.70	33.08	16.54	3.308
2	2 573	257.3	128.7	51.46	25.73	5.146

Accuracy of outputs

The outputs have the following base accuracy specifications.

Current output

Accuracy	$\pm 5 \mu\text{A}$
-----------------	---------------------

Pulse/frequency output

o.r. = of reading

Accuracy	Max. ± 50 ppm o.r. (over the entire ambient temperature range)
-----------------	--------------------------------------------------------------------

Repeatability

o.r. = of reading; $1 \text{ g/cm}^3 = 1 \text{ kg/l}$; T = medium temperature

Base repeatability

 Design fundamentals →  51

Mass flow and volume flow (liquids)

±0.05 % o.r.

Mass flow (gases)

±0.25 % o.r. (tantalum)

Density (liquids)

±0.00025 g/cm³

Temperature

±0.25 °C ± 0.0025 · T °C (±0.45 °F ± 0.0015 · (T-32) °F)

Response time

The response time depends on the configuration (damping).

Influence of ambient temperature**Current output**

Temperature coefficient	Max. 1 µA/°C
--------------------------------	--------------

Pulse/frequency output

Temperature coefficient	No additional effect. Included in accuracy.
--------------------------------	---------------------------------------------

Influence of medium temperature**Mass flow and volume flow**

o.f.s. = of full scale value

When there is a difference between the temperature for zero point adjustment and the process temperature, the additional measured error of the sensor is typically ±0.0002 % o.f.s./°C (±0.0001 % o. f.s./°F).

The effect is reduced if zero point adjustment is performed at process temperature.

Density

When there is a difference between the density calibration temperature and the process temperature, the typical measured error of the sensor is ±0.0001 g/cm³ /°C (±0.00005 g/cm³ /°F). Field density calibration is possible.

Wide-range density specification (special density calibration)

If the process temperature is outside the valid range (→  48) the measured error is ±0.0001 g/cm³ /°C (±0.00005 g/cm³ /°F)

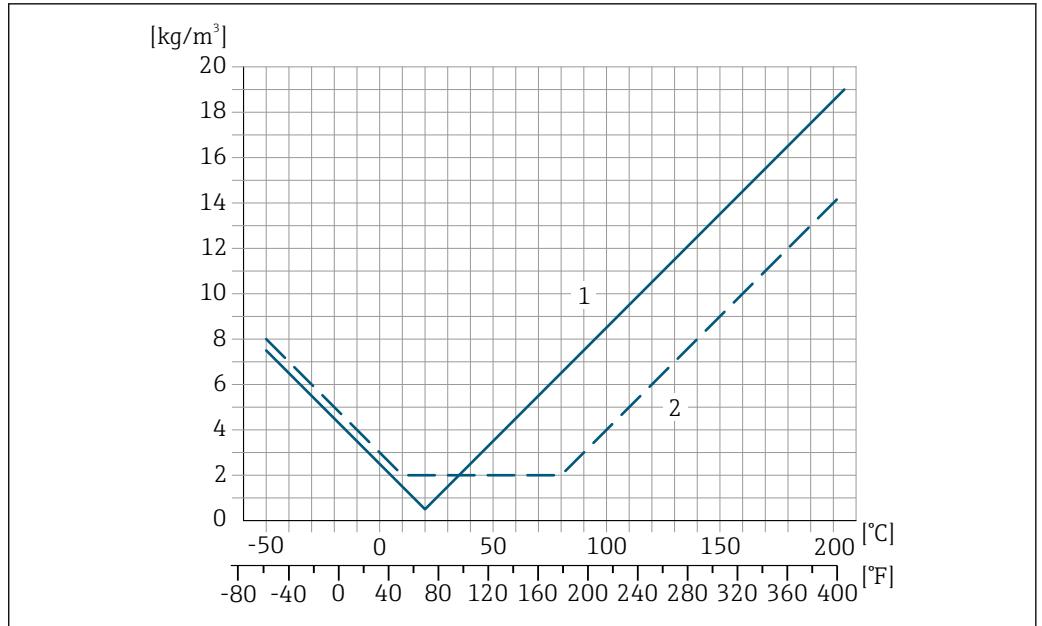

- 1 Field density calibration, for example at +20 °C (+68 °F)
- 2 Special density calibration

Temperature

$\pm 0.005 \cdot T \text{ } ^\circ\text{C}$ ($\pm 0.005 \cdot (T - 32) \text{ } ^\circ\text{F}$)

Influence of medium pressure

The table below shows the effect on accuracy of mass flow due to a difference between calibration pressure and process pressure.

o.r. = of reading

- It is possible to compensate for the effect by:
 - Reading in the current pressure measured value via the current input.
 - Specifying a fixed value for the pressure in the device parameters.

Operating Instructions → 101.

DN		Promass H zirconium 702/R 60702		Promass H tantalum 2.5W	
[mm]	[in]	[% o.r./bar]	[% o.r./psi]	[% o.r./bar]	[% o.r./psi]
8	3/8	-0.017	-0.0012	-0.007	-0.0005
15	1/2	-0.021	-0.0014	-0.005	-0.0003
25	1	-0.013	-0.0009	-0.015	-0.0010
40	1 1/2	-0.018	-0.0012	-0.012	-0.0008
50	2	-0.015	-0.0010	-0.011	-0.0008

Design fundamentals

o.r. = of reading, o.f.s. = of full scale value

BaseAccu = base accuracy in % o.r., BaseRepeat = base repeatability in % o.r.

MeasValue = measured value; ZeroPoint = zero point stability

Calculation of the maximum measured error as a function of the flow rate

Flow rate	Maximum measured error in % o.r.
$\geq \frac{\text{ZeroPoint}}{\text{BaseAccu}} \cdot 100$ <small>A0021332</small>	$\pm \text{BaseAccu}$ <small>A0021339</small>
$< \frac{\text{ZeroPoint}}{\text{BaseAccu}} \cdot 100$ <small>A0021333</small>	$\pm \frac{\text{ZeroPoint}}{\text{MeasValue}} \cdot 100$ <small>A0021334</small>

Calculation of the maximum repeatability as a function of the flow rate

Flow rate	Maximum repeatability in % o.r.
$\geq \frac{1/2 \cdot \text{ZeroPoint}}{\text{BaseRepeat}} \cdot 100$ <small>A0021335</small>	$\pm \text{BaseRepeat}$ <small>A0021340</small>
$< \frac{1/2 \cdot \text{ZeroPoint}}{\text{BaseRepeat}} \cdot 100$ <small>A0021336</small>	$\pm \frac{1}{2} \cdot \frac{\text{ZeroPoint}}{\text{MeasValue}} \cdot 100$ <small>A0021337</small>

Example for maximum measured error

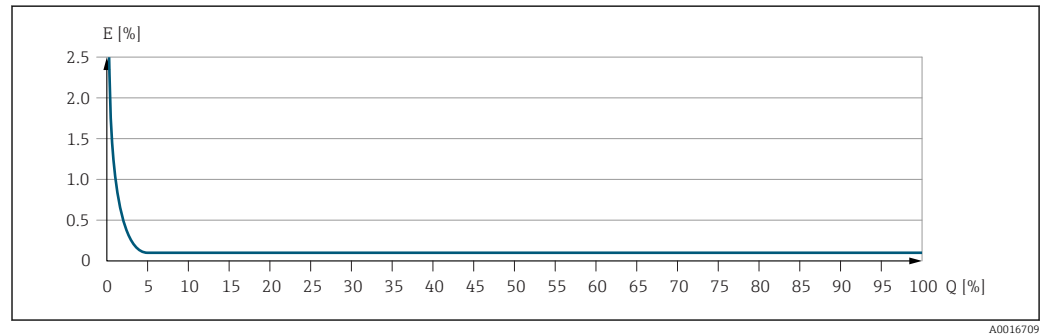

E Maximum measured error in % o.r. (example)
Q Flow rate in % of maximum full scale value

Installation

No special measures such as supports etc. are necessary. External forces are absorbed by the construction of the device.

Mounting location

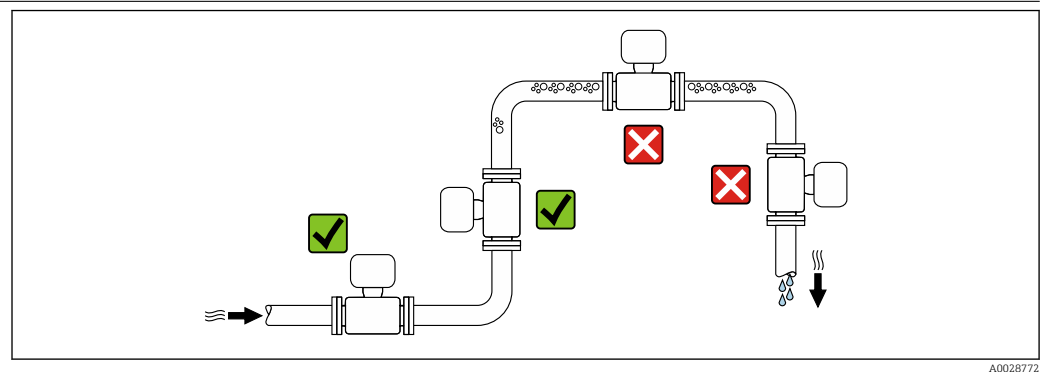

To prevent measuring errors arising from accumulation of gas bubbles in the measuring tube, avoid the following mounting locations in the pipe:

- Highest point of a pipeline.
- Directly upstream of a free pipe outlet in a down pipe.

Installation in down pipes

However, the following installation suggestion allows for installation in an open vertical pipeline. Pipe restrictions or the use of an orifice with a smaller cross-section than the nominal diameter prevent the sensor running empty while measurement is in progress.

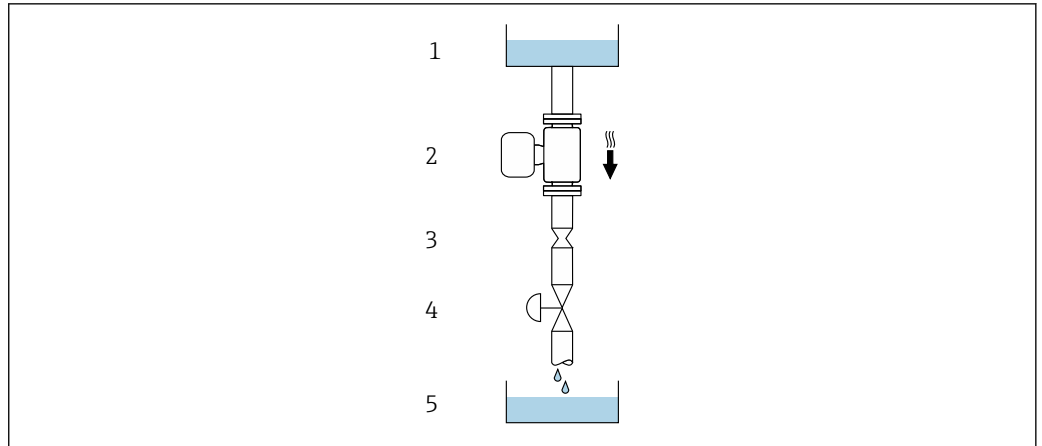

A0028773

20 Installation in a down pipe (e.g. for batching applications)

- 1 Supply tank
- 2 Sensor
- 3 Orifice plate, pipe restriction
- 4 Valve
- 5 Batching tank

DN		Ø orifice plate, pipe restriction	
[mm]	[in]	[mm]	[in]
8	3/8	6	0.24
15	1/2	10	0.40
25	1	14	0.55
40	1 1/2	22	0.87
50	2	28	1.10

Orientation

The direction of the arrow on the sensor nameplate helps you to install the sensor according to the flow direction (direction of medium flow through the piping).

Orientation		Recommendation
A	Vertical orientation	 A0015591
B	Horizontal orientation, transmitter at top	 A0015589
C	Horizontal orientation, transmitter at bottom	 A0015590
D	Horizontal orientation, transmitter at side	 A0015592

- 1) This orientation is recommended to ensure self-draining.
- 2) Applications with low process temperatures may decrease the ambient temperature. To maintain the minimum ambient temperature for the transmitter, this orientation is recommended.
- 3) Applications with high process temperatures may increase the ambient temperature. To maintain the maximum ambient temperature for the transmitter, this orientation is recommended.

If a sensor is installed horizontally with a curved measuring tube, match the position of the sensor to the fluid properties.

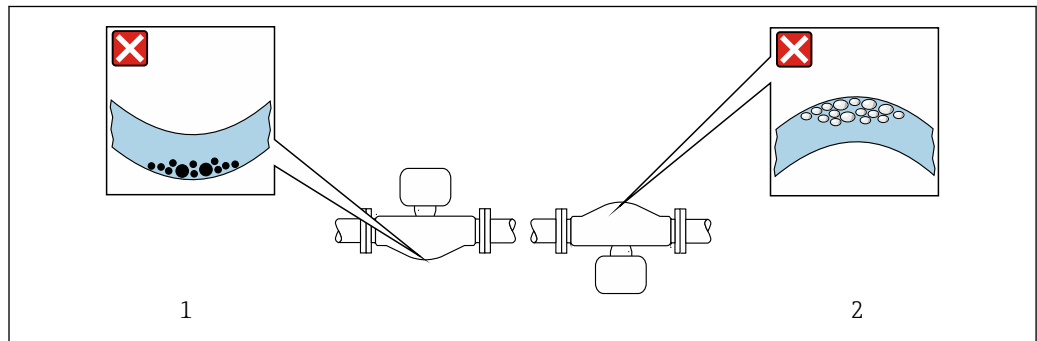

21 Orientation of sensor with curved measuring tube

- 1 Avoid this orientation for fluids with entrained solids: Risk of solids accumulating.
- 2 Avoid this orientation for outgassing fluids: Risk of gas accumulating.

Inlet and outlet runs

No special precautions need to be taken for fittings which create turbulence, such as valves, elbows or T-pieces, as long as no cavitation occurs → 61.

Mounting the transmitter housing

Proline 500 – digital transmitter

Post mounting

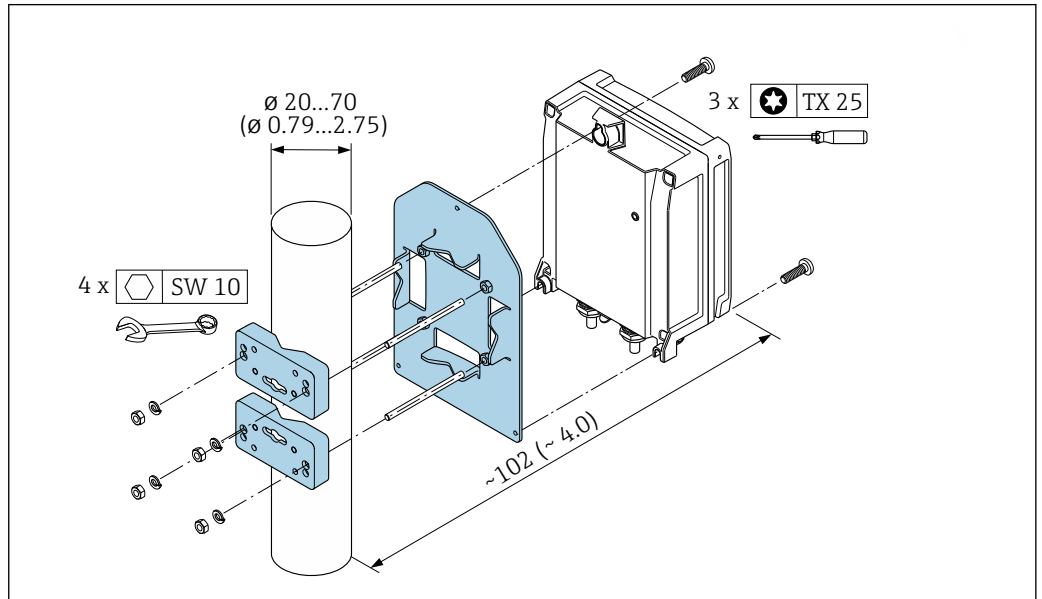

A0029051

22 Engineering unit mm (in)

Wall mounting

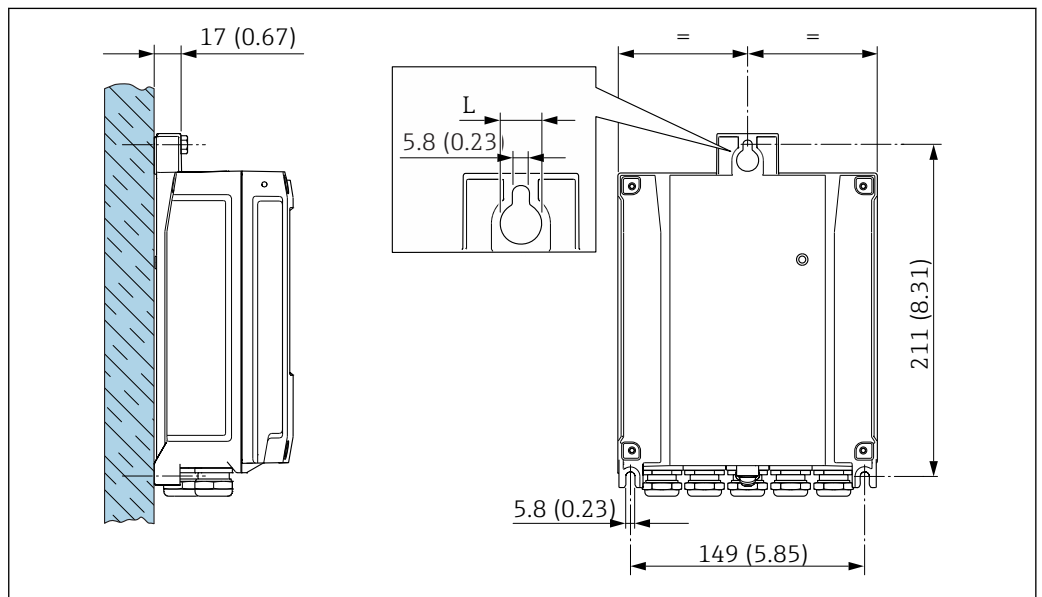

A0029054

23 Engineering unit mm (in)

L Depends on order code for "Transmitter housing"

Order code for "Transmitter housing"

- Option **A**, aluminum coated: L = 14 mm (0.55 in)
- Option **D**, polycarbonate: L = 13 mm (0.51 in)

Proline 500 transmitter

Post mounting



Order code for "Transmitter housing", option L "Cast, stainless": cast transmitters are very heavy.

They are unstable if they are not mounted on a secure, fixed post.

- Only mount the transmitter on a secure, fixed post on a stable surface.

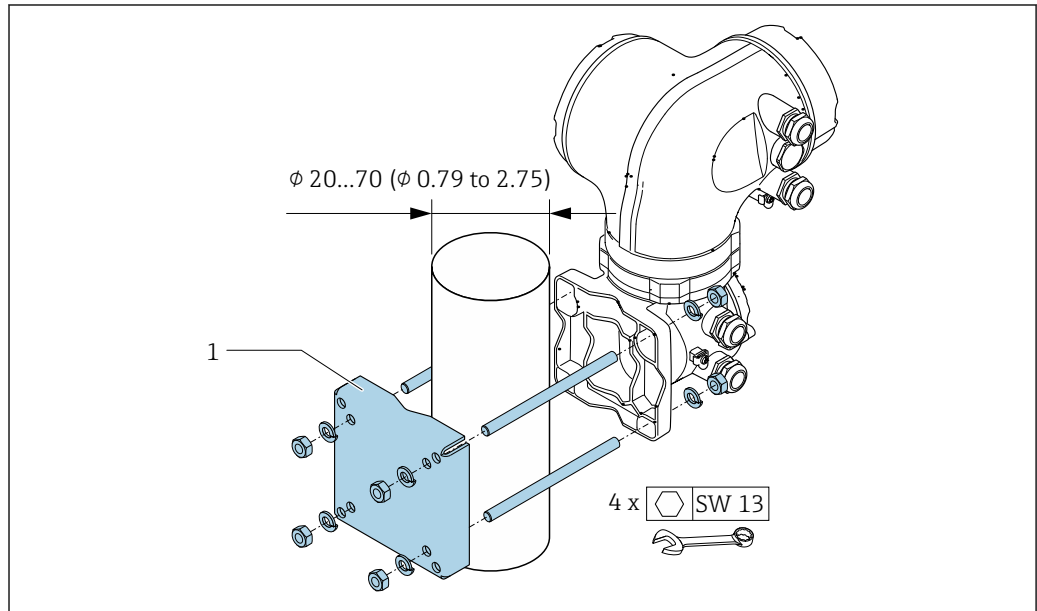

A0029057

24 Engineering unit mm (in)

Wall mounting

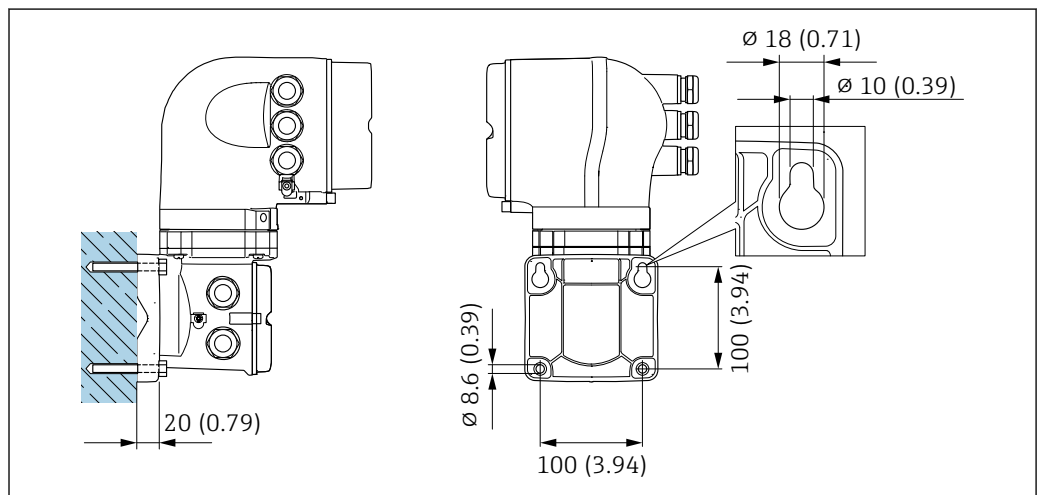

A0029068

25 Engineering unit mm (in)

Special mounting instructions

Drainability

The measuring tubes can be completely drained and protected against solids build-up in vertical orientation.

Zero point adjustment

All measuring devices are calibrated in accordance with state-of-the-art technology. Calibration takes place under reference conditions → 48. Therefore, a zero point adjustment in the field is generally not required.

Experience shows that zero point adjustment is advisable only in special cases:

- To achieve maximum measuring accuracy even with low flow rates.
- Under extreme process or operating conditions (e.g. very high process temperatures or very high-viscosity fluids).

Protective cover

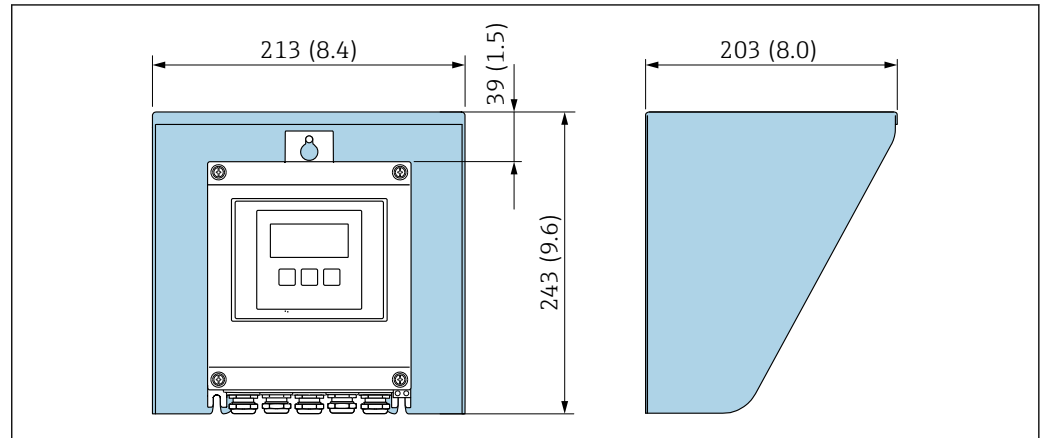

26 Weather protection cover for Proline 500 – digital

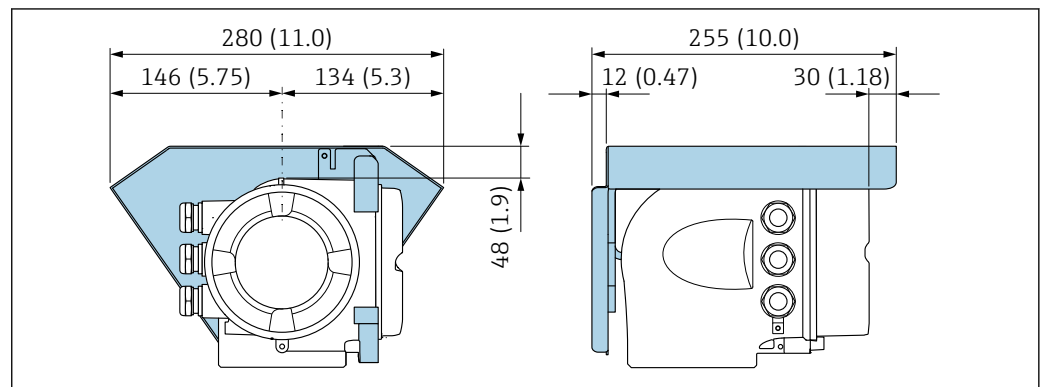

27 Weather protection cover for Proline 500



Environment



Ambient temperature range

Measuring device	<ul style="list-style-type: none"> ■ -40 to +60 °C (-40 to +140 °F) ■ Order code for "Test, certificate", option JP: -50 to +60 °C (-58 to +140 °F)
Readability of the local display	-20 to +60 °C (-4 to +140 °F) The readability of the display may be impaired at temperatures outside the temperature range.

i Dependency of ambient temperature on medium temperature → 58

- ▶ If operating outdoors:
Avoid direct sunlight, particularly in warm climatic regions.

 You can order a weather protection cover from Endress+Hauser. →  98.

Storage temperature	-50 to +80 °C (-58 to +176 °F)
Climate class	DIN EN 60068-2-38 (test Z/AD)
Degree of protection	<p>Transmitter</p> <ul style="list-style-type: none"> ■ As standard: IP66/67, type 4X enclosure ■ When housing is open: IP20, type 1 enclosure ■ Display module: IP20, type 1 enclosure <p>Sensor</p> <ul style="list-style-type: none"> ■ As standard: IP66/67, type 4X enclosure ■ With the order code for "Sensor options", option CM: IP69 can also be ordered <p>External WLAN antenna IP67</p>
Vibration resistance	<ul style="list-style-type: none"> ■ Oscillation, sinusoidal, following IEC 60068-2-6 2 to 8.4 Hz, 3.5 mm peak ■ Oscillation, broadband noise following IEC 60068-2-64 <ul style="list-style-type: none"> - 10 to 200 Hz, 0.003 g²/Hz - 200 to 2 000 Hz, 0.001 g²/Hz - Total: 1.54 g rms
Shock resistance	Shock, half-sine according to IEC 60068-2-27 6 ms 50 g
Shock resistance	Shock due to rough handling following IEC 60068-2-31
Interior cleaning	<ul style="list-style-type: none"> ■ Cleaning in place (CIP) ■ Sterilization in place (SIP) <p>Options Oil- and grease-free version for wetted parts, without declaration Order code for "Service", option HA</p>
Electromagnetic compatibility (EMC)	<ul style="list-style-type: none"> ■ As per IEC/EN 61326 and NAMUR Recommendation 21 (NE 21) ■ Device version with PROFIBUS DP: Complies with emission limits for industry as per EN 50170 Volume 2, IEC 61784 <p> The following applies for PROFIBUS DP: If baud rates > 1.5 MBaud, an EMC cable entry must be used and the cable shield must continue as far as the terminal wherever possible.</p> <p> Details are provided in the Declaration of Conformity.</p>

Process

Medium temperature range

-50 to +205 °C (-58 to +401 °F) for zirconium 702/R 60702	Order code for "Measuring tube mat., wetted surface", option DA
-50 to +150 °C (-58 to +302 °F) for tantalum 2.5 W	Order code for "Measuring tube mat., wetted surface", option EA

Dependency of ambient temperature on medium temperature

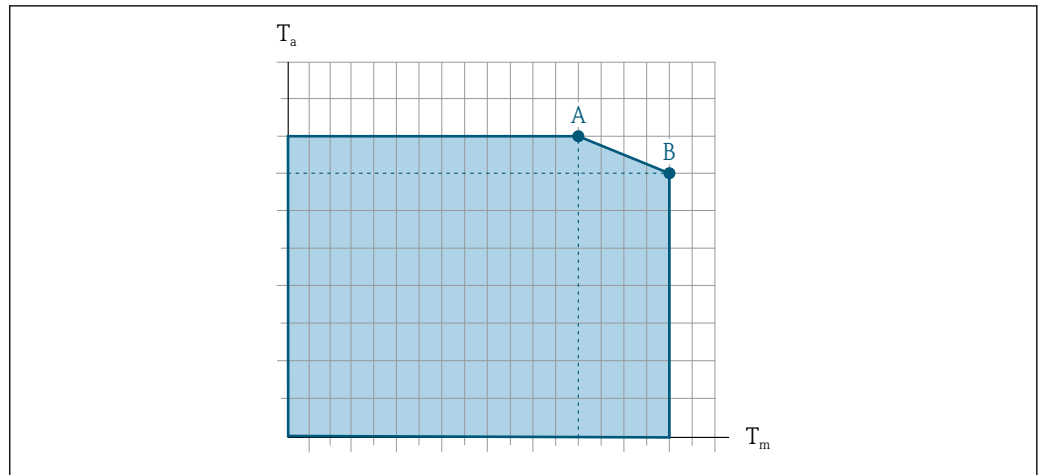

28 Exemplary representation, values in the table below.

T_a Ambient temperature

T_m Medium temperature

A Maximum permitted medium temperature T_m at $T_{a\max} = 60\text{ °C}$ (140 °F); higher medium temperatures T_m require a reduced ambient temperature T_a

B Maximum permitted ambient temperature T_a for the maximum specified medium temperature T_m of the sensor



Values for devices used in the hazardous area:

Separate Ex documentation (XA) for the device → 102.

Version ¹⁾	Not insulated				Insulated			
	A		B		A		B	
	T_a	T_m	T_a	T_m	T_a	T_m	T_a	T_m
Tantalum (order code for "Measuring tube mat.", option EA)	60 °C (140 °F)	150 °C (302 °F)	-	-	60 °C (140 °F)	150 °C (302 °F)	-	-
Zirconium 702 (order code for "Measuring tube mat.", option DA)	60 °C (140 °F)	205 °C (401 °F)	-	-	60 °C (140 °F)	150 °C (302 °F)	55 °C (131 °F)	205 °C (401 °F)

1) The values apply for Promass H 500 - digital and Promass H 500.

Density 0 to 5 000 kg/m³ (0 to 312 lb/cf)

Pressure-temperature ratings The following pressure/temperature diagrams apply to all pressure-bearing parts of the device and not just the process connection. The diagrams show the maximum permissible medium pressure depending on the specific medium temperature.

Flange connection according to EN 1092-1 (DIN 2501)

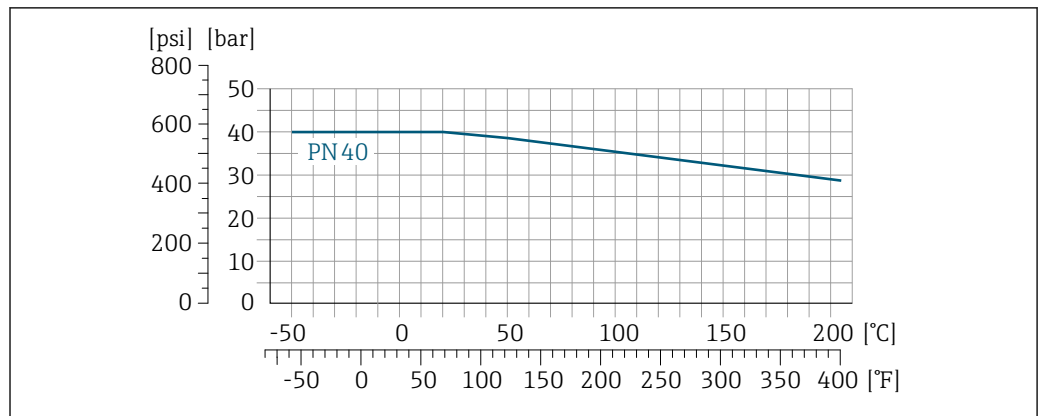

A0027769-EN

29 With flange material 1.4301 (304); wetted parts: zirconium 702, tantalum

The material load curves for the temperature range +150 to +205 °C (+302 to +401 °F) apply only to the order code for "Measuring tube material", option TJ

Flange connection according to ASME B16.5

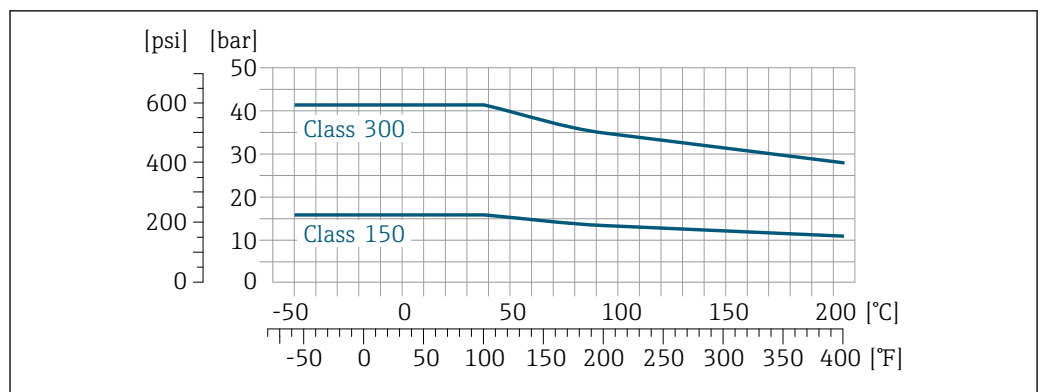

A0027771-EN

30 With flange material 1.4301 (304); wetted parts: zirconium 702, tantalum

The material load curves for the temperature range +150 to +205 °C (+302 to +401 °F) apply only to the order code for "Measuring tube material", option TJ

Flange connection according to JIS B2220

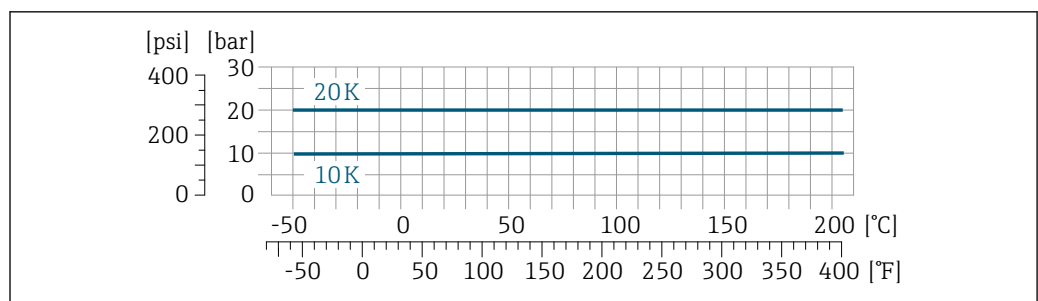

A0027772-EN

31 With flange material 1.4301 (304); wetted parts: zirconium 702, tantalum

The material load curves for the temperature range +150 to +205 °C (+302 to +401 °F) apply only to the order code for "Measuring tube material", option TJ

Sensor housing

The sensor housing is filled with dry nitrogen gas and protects the electronics and mechanics inside.

 If a measuring tube fails (e.g. due to process characteristics like corrosive or abrasive fluids), the fluid will initially be contained by the sensor housing.

If the sensor is to be purged with gas (gas detection), it should be equipped with purge connections.

 Do not open the purge connections unless the containment can be filled immediately with a dry, inert gas. Use only low pressure to purge. Maximum pressure: 5 bar (72.5 psi).

Sensor housing nominal pressure rating and burst pressure

The following sensor housing nominal pressure ratings/burst pressures are only valid for standard devices and/or devices equipped with closed purge connections (not opened/as delivered).

If a device fitted with purge connections (order code for "Sensor option", option CH "Purge connection") is connected to the purge system, the maximum nominal pressure is determined by the purge system itself or by the device, depending on which component has the lower nominal pressure classification.

The sensor housing burst pressure refers to a typical internal pressure which is reached prior to mechanical failure of the sensor housing and which was determined during type testing. The corresponding type test declaration can be ordered with the device (order code for "Additional approval", option LN "Sensor housing burst pressure, type test").

DN		Sensor housing nominal pressure (designed with a safety factor ≥ 4)		Sensor housing burst pressure	
[mm]	[in]	[bar]	[psi]	[bar]	[psi]
8	3/8	25	362	170	2465
15	1/2	25	362	160	2320
25	1	25	362	130	1885
40	1 1/2	16	232	85	1232
50	2	16	232	85	1232



For information on the dimensions: see the "Mechanical construction" section →  63

Flow limit



Select the nominal diameter by optimizing between the required flow range and permissible pressure loss.

 For an overview of the full scale values for the measuring range, see the "Measuring range" section →  11

- The minimum recommended full scale value is approx. 1/20 of the maximum full scale value
- In most applications, 20 to 50 % of the maximum full scale value can be considered ideal
- A low full scale value must be selected for abrasive media (such as liquids with entrained solids): flow velocity < 1 m/s (< 3 ft/s).
- For gas measurement the following rules apply:
 - The flow velocity in the measuring tubes should not exceed half the sound velocity (0.5 Mach).
 - The maximum mass flow depends on the density of the gas: formula →  11

 To calculate the flow limit, use the *Applicator* sizing tool →  100

Pressure loss

 To calculate the pressure loss, use the *Applicator* sizing tool →  100

System pressure

It is important that cavitation does not occur, or that gases entrained in the liquids do not outgas. This is prevented by means of a sufficiently high system pressure.

For this reason, the following mounting locations are recommended:

- At the lowest point in a vertical pipe
- Downstream from pumps (no danger of vacuum)

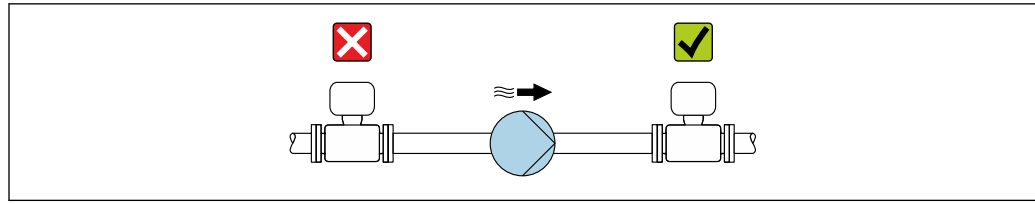

A0028777

Thermal insulation

In the case of some fluids, it is important to keep the heat radiated from the sensor to the transmitter to a low level. A wide range of materials can be used for the required insulation.

The following device versions are recommended for versions with thermal insulation:

Version with extended neck:

Order code for "Measuring tube material", option DA or EA with an extended neck length of 105 mm (4.13 in).

NOTICE

Electronics overheating on account of thermal insulation!

- ▶ Recommended orientation: horizontal orientation, sensor connection housing pointing downwards.
- ▶ Do not insulate the sensor connection housing.
- ▶ Maximum permissible temperature at the lower end of the sensor connection housing: 80 °C (176 °F)
- ▶ Thermal insulation with extended neck free: We recommend that you do not insulate the extended neck in order to ensure optimum dissipation of heat.

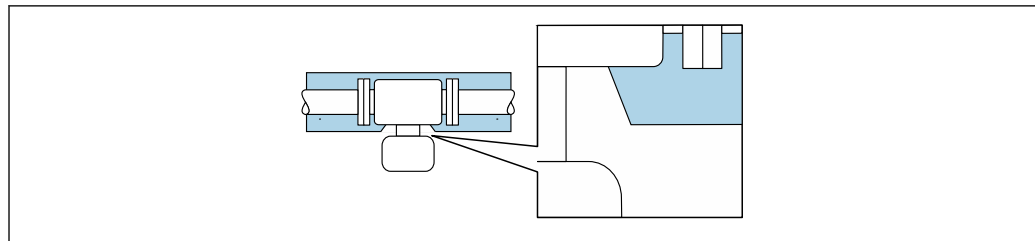

A0034391

32 Thermal insulation with extended neck free

Heating

Some fluids require suitable measures to avoid loss of heat at the sensor.

Heating options

- Electrical heating, e.g. with electric band heaters
- Via pipes carrying hot water or steam
- Via heating jackets



Heating jackets for the sensors can be ordered as accessories from Endress+Hauser .-> 99

NOTICE

Danger of overheating when heating

- ▶ Ensure that the temperature at the lower end of the transmitter housing does not exceed 80 °C (176 °F).
- ▶ Ensure that sufficient convection takes place at the transmitter neck.
- ▶ Ensure that a sufficiently large area of the transmitted neck remains exposed. The uncovered part serves as a radiator and protects the electronics from overheating and excessive cooling.
- ▶ If using in potentially explosive atmospheres, observe the information in the device-specific Ex documentation. For detailed information on the temperature tables, see the separate document entitled "Safety Instructions" (XA) for the device.

Vibrations

The high oscillation frequency of the measuring tubes ensures that the correct operation of the measuring system is not influenced by plant vibrations.

Mechanical construction

Dimensions in SI units

Housing of Proline 500 – digital transmitter

Non-hazardous area or hazardous area: Zone 2; Class I, Division 2

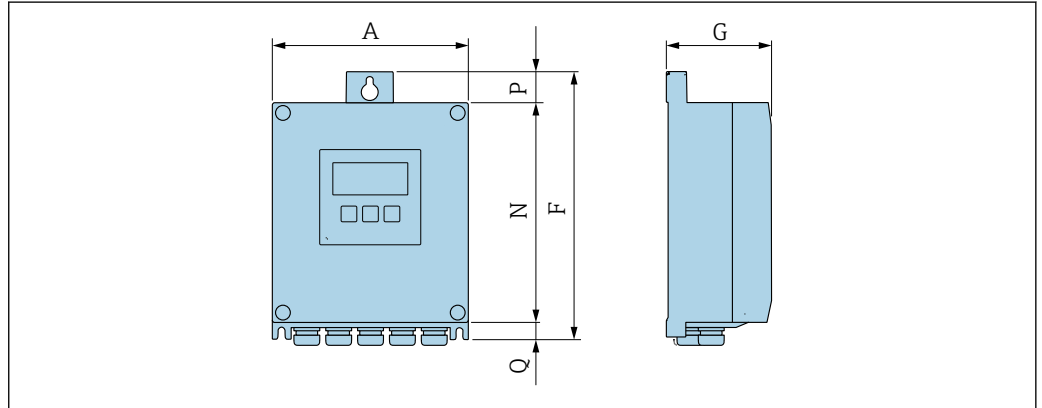

A0033789

Order code for "Transmitter housing", option A "Aluminum, coated" and order code for "Integrated ISEM electronics", option A "Sensor"

A [mm]	F [mm]	G [mm]	N [mm]	P [mm]	Q [mm]
167	232	80	187	24	21

Order code for "Transmitter housing", option D "Polycarbonate" and order code for "Integrated ISEM electronics", option A "Sensor"

A [mm]	F [mm]	G [mm]	N [mm]	P [mm]	Q [mm]
177	234	90	197	17	22

Housing of Proline 500 transmitter

Hazardous area: Zone 2; Class I, Division 2 or Zone 1; Class I, Division 1

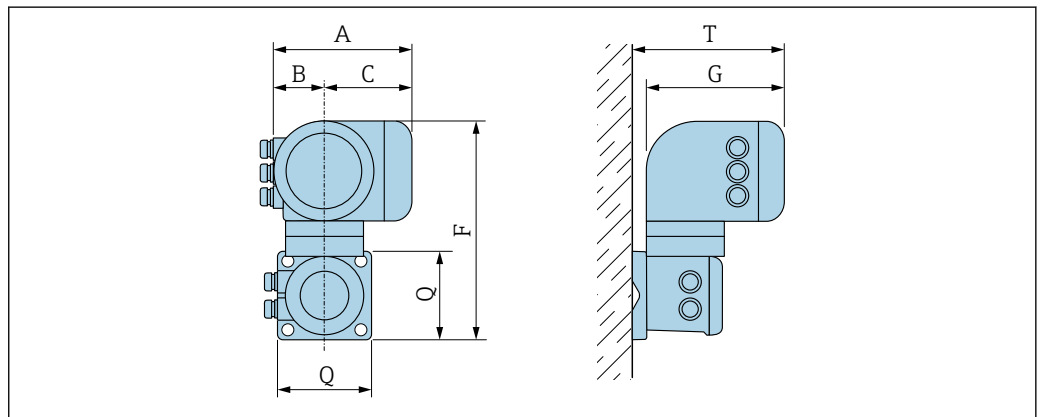

A0033788

Order code for "Transmitter housing", option A "Aluminum, coated" and order code for "Integrated ISEM electronics", option B "Transmitter"

A [mm]	B [mm]	C [mm]	F [mm]	G [mm]	Q [mm]	T [mm]
188	85	103	318	217	130	239

Order code for "Transmitter housing", option L "Cast, stainless" and order code for "Integrated ISEM electronics", option B "Transmitter"

A [mm]	B [mm]	C [mm]	F [mm]	G [mm]	Q [mm]	T [mm]
188	85	103	295	217	130	239

Sensor connection housing

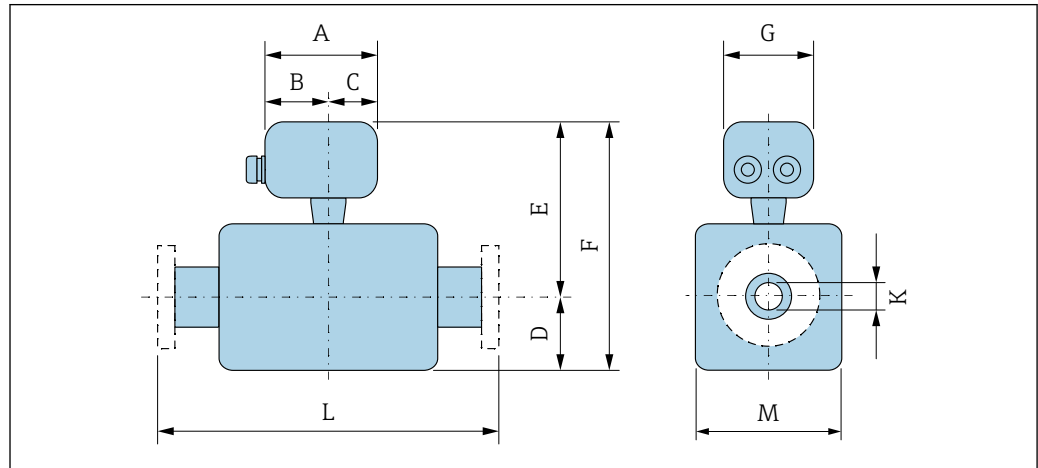

Order code for "Sensor connection housing", option A "Aluminum, coated"

DN [mm]	A ¹⁾ [mm]	B [mm]	C [mm]	D [mm]	E [mm]	F [mm]	G [mm]	K [mm]	L [mm]	M [mm]
8	148	94	54	108	261	369	136	5.35	²⁾	92
15	148	94	54	108	261	369	136	8.30	²⁾	92
25	148	94	54	121	261	382	136	12.0	²⁾	92
40	148	94	54	173	285	458	136	17.6	²⁾	132
50	148	94	54	241	296	537	136	26.0	²⁾	167

- 1) Depending on the cable gland used: values up to + 30 mm
- 2) Dependent on the respective process connection

Order code for "Sensor connection housing", option B "Stainless"

DN [mm]	A ¹⁾ [mm]	B ¹⁾ [mm]	C [mm]	D [mm]	E [mm]	F [mm]	G [mm]	K [mm]	L [mm]	M [mm]
8	137	78	59	108	257	365	134	5.35	²⁾	92
15	137	78	59	108	257	365	134	8.30	²⁾	92
25	137	78	59	121	257	378	134	12.0	²⁾	92
40	137	78	59	173	281	454	134	17.6	²⁾	132
50	137	78	59	241	292	533	134	26.0	²⁾	167

- 1) Depending on the cable gland used: values up to + 30 mm
- 2) Dependent on the respective process connection

Order code for "Sensor connection housing", option C "Ultra-compact hygienic, stainless"

DN [mm]	¹⁾ A [mm]	¹⁾ B [mm]	C [mm]	D [mm]	E [mm]	F [mm]	G [mm]	K [mm]	L [mm]	M [mm]
8	124	68	56	108	257	365	112	5.35	²⁾	92
15	124	68	56	108	257	365	112	8.30	²⁾	92
25	124	68	56	121	257	378	112	12.0	²⁾	92
40	124	68	56	173	281	454	112	17.6	²⁾	132
50	124	68	56	241	292	533	112	26.0	²⁾	167

- 1) Depending on the cable gland used: values up to + 30 mm
- 2) Dependent on the respective process connection

Order code for "Sensor connection housing", option L "Cast, stainless"

DN [mm]	A ¹⁾ [mm]	B [mm]	C [mm]	D [mm]	E [mm]	F [mm]	G [mm]	K [mm]	L [mm]	M [mm]
8	145	86	59	108	284	392	136	5.35	²⁾	92
15	145	86	59	108	284	392	136	8.30	²⁾	92
25	145	86	59	121	284	405	136	12.0	²⁾	92
40	145	86	59	173	308	481	136	17.6	²⁾	132
50	145	86	59	241	319	560	136	26.0	²⁾	167

- 1) Depending on the cable gland used: values up to + 30 mm
- 2) Dependent on the respective process connection

Flange connections

Fixed flange EN 1092-1, ASME B16.5, JIS B2220

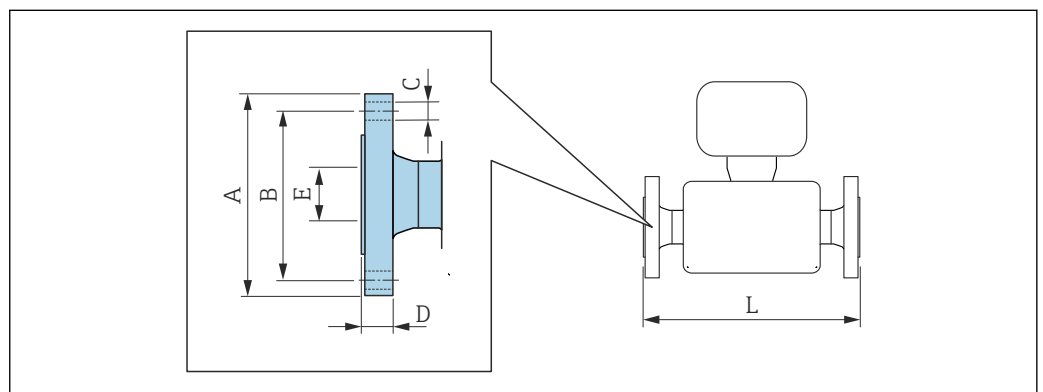

A0015621

i Length tolerance for dimension L in mm:
+1.5 / -2.0

Flange according to EN 1092-1 (DIN 2501): PN 40 1.4404 (316/316L) Order code for "Process connection", option D2W						
DN [mm]	A [mm]	B [mm]	C [mm]	D [mm]	E [mm]	L [mm]
8 ¹⁾	95	65	4 × Ø14	20	17.3	336
15	95	65	4 × Ø14	20	17.3	440
25	115	85	4 × Ø14	19.0	28.5	580

Flange according to EN 1092-1 (DIN 2501): PN 40 1.4404 (316/316L) <i>Order code for "Process connection", option D2W</i>						
DN [mm]	A [mm]	B [mm]	C [mm]	D [mm]	E [mm]	L [mm]
40	150	110	4 × Ø18	21.5	43.1	794
50	165	125	4 × Ø18	23.5	54.5	1071
Surface roughness (flange): EN 1092-1 Form B1 (DIN 2526 Form C), Ra 3.2 to 12.5 µm						

1) DN 8 with DN 15 flanges as standard

Flange according to ASME B16.5: Cl 150 1.4404 (316/316L) <i>Order code for "Process connection", option AAW</i>						
DN [mm]	A [mm]	B [mm]	C [mm]	D [mm]	E [mm]	L [mm]
8 ¹⁾	90	60.3	4 × Ø15.7	12.8	15.7	336
15	90	60.3	4 × Ø15.7	12.8	15.7	440
25	110	79.4	4 × Ø15.7	15.1	26.7	580
40	125	98.4	4 × Ø15.7	17.5	40.9	794
50	150	120.7	4 × Ø19.1	23.6	52.6	1071
Surface roughness (flange): Ra 3.2 to 6.3 µm						

1) DN 8 with DN 15 flanges as standard

Flange according to ASME B16.5: Cl 300 1.4404 (316/316L) <i>Order code for "Process connection", option ABW</i>						
DN [mm]	A [mm]	B [mm]	C [mm]	D [mm]	E [mm]	L [mm]
8 ¹⁾	95	66.7	4 × Ø15.7	14.2	15.7	336
15	95	66.7	4 × Ø15.7	14.2	15.7	440
25	125	88.9	4 × Ø19.1	17.5	26.7	580
40	155	114.3	4 × Ø22.3	20.6	40.9	794
50	165	127.0	8 × Ø19.1	23.6	52.6	1071
Surface roughness (flange): Ra 3.2 to 6.3 µm						

1) DN 8 with DN 15 flanges as standard

Flange JIS B2220: 10K 1.4301 (304), wetted parts: titanium <i>Order code for "Process connection", option NDW</i>						
DN [mm]	A [mm]	B [mm]	C [mm]	D [mm]	E [mm]	L [mm]
50	155	120	4 × Ø19	18.5	50	1071

Flange JIS B2220: 20K 1.4404 (316/316L) Order code for "Process connection", option NEW						
DN [mm]	A [mm]	B [mm]	C [mm]	D [mm]	E [mm]	L [mm]
8 ¹⁾	95	70	4 × Ø15	14	15	336
15	95	70	4 × Ø15	14	15	440
25	125	90	4 × Ø19	16	25	580
40	140	105	4 × Ø19	18	40	794
50	165	120	8 × Ø19	22	50	1071

Surface roughness (flange): Ra 3.2 to 6.3 µm

1) DN 8 with DN 15 flanges as standard

Accessories

Rinse connections

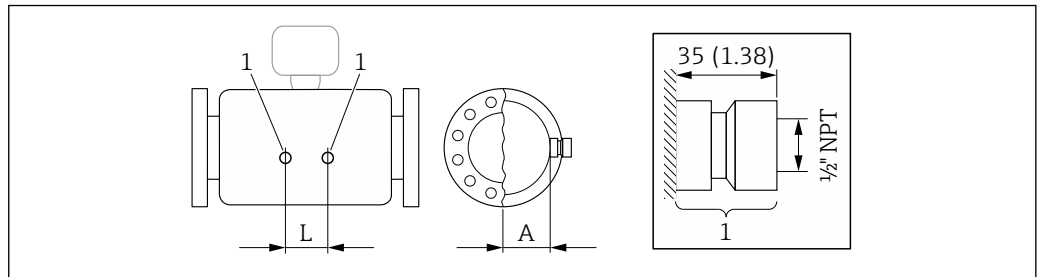

A0029969

1 Connection nipple for purge connections: order code for "Sensor options", option CH "Purge connection"

DN [mm]	A [mm]	L [mm]
8	47	110
15	47	204
25	47	348
40	67	526
50	84.5	763

Protective cover

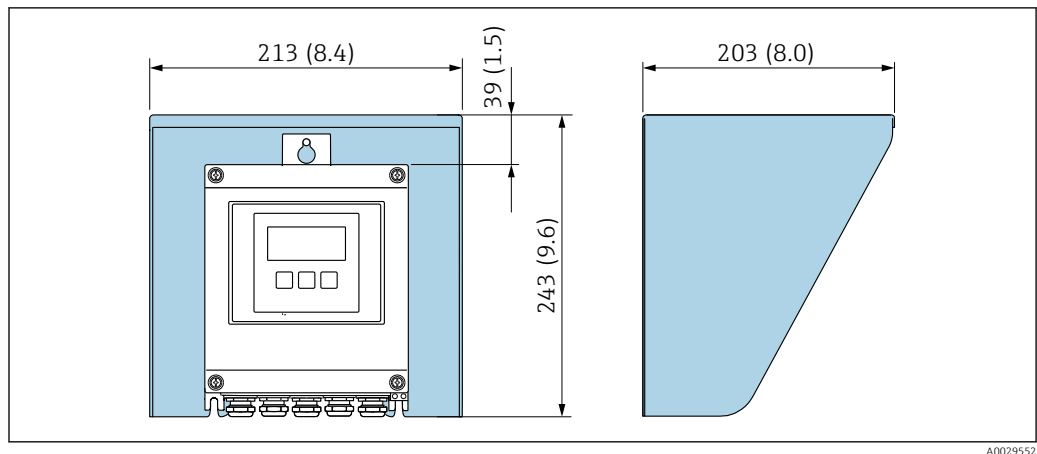

A0029552

33 Weather protection cover for Proline 500 – digital

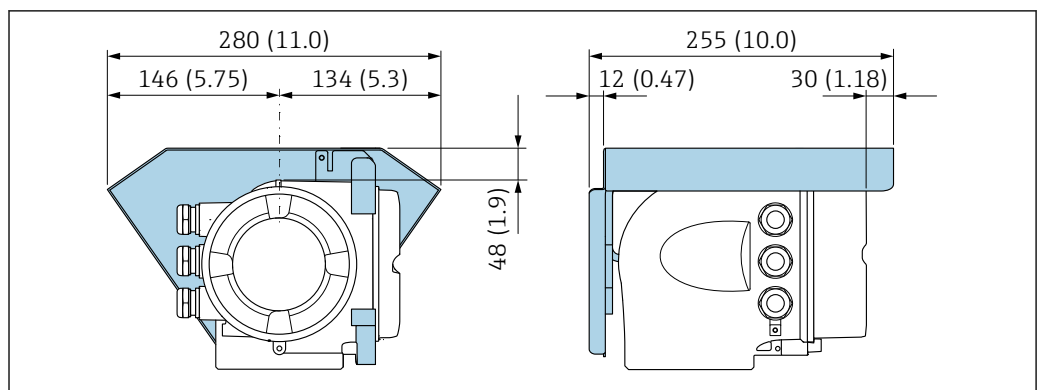

A0029553

34 Weather protection cover for Proline 500

External WLAN antenna

 The external WLAN antenna is not suitable for use in hygienic applications.

Proline 500 – digital

External WLAN antenna mounted on device

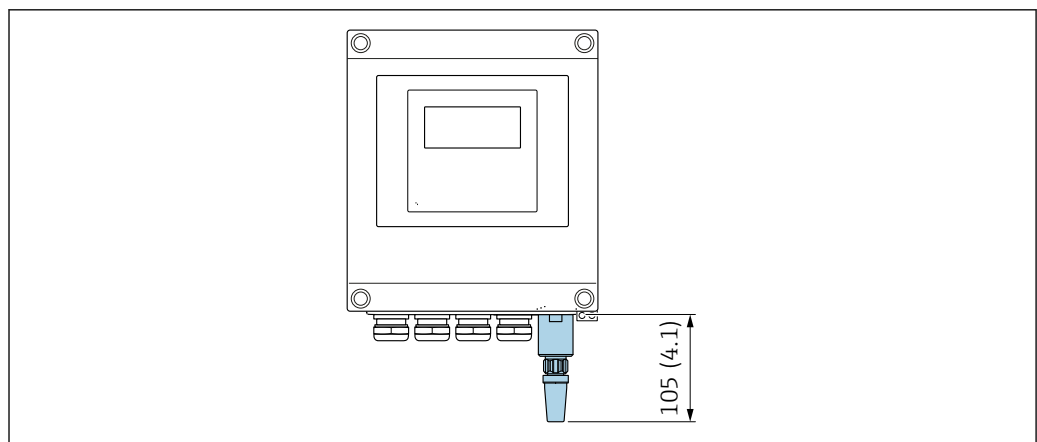

A0033607

35 Engineering unit mm (in)

External WLAN antenna mounted with cable

The external WLAN antenna can be mounted separately from the transmitter if the transmission/reception conditions at the transmitter mounting location are poor.

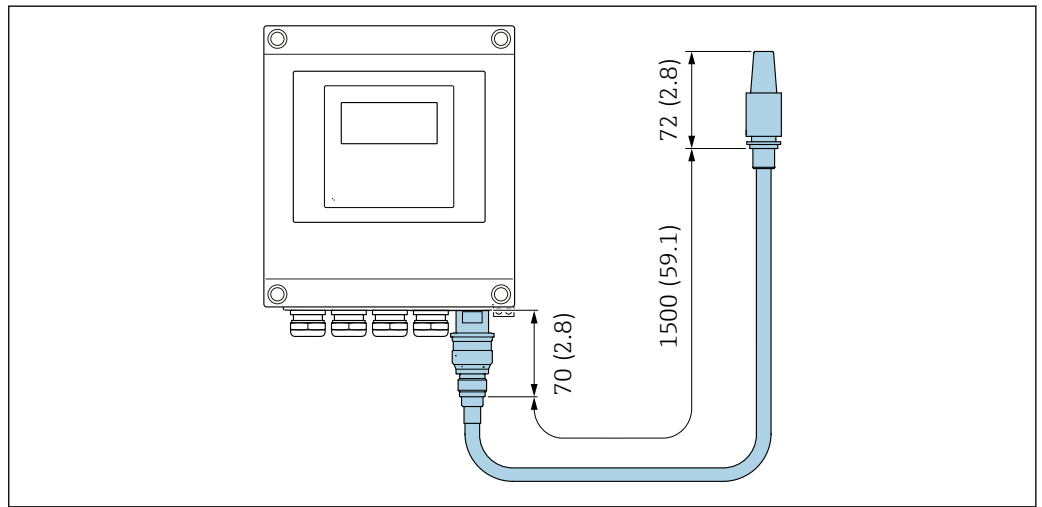

A0033606

36 Engineering unit mm (in)

Proline 500

External WLAN antenna mounted on device

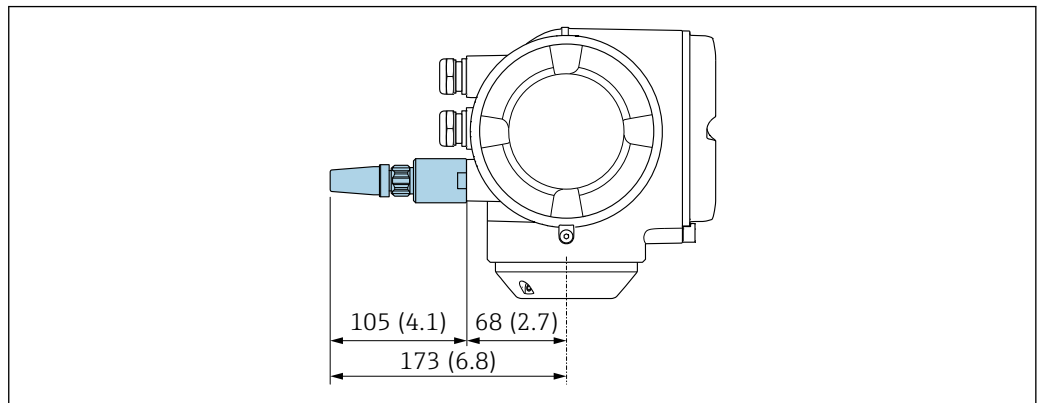

A0028923

37 Engineering unit mm (in)

External WLAN antenna mounted with cable

The external WLAN antenna can be mounted separately from the transmitter if the transmission/reception conditions at the transmitter mounting location are poor.

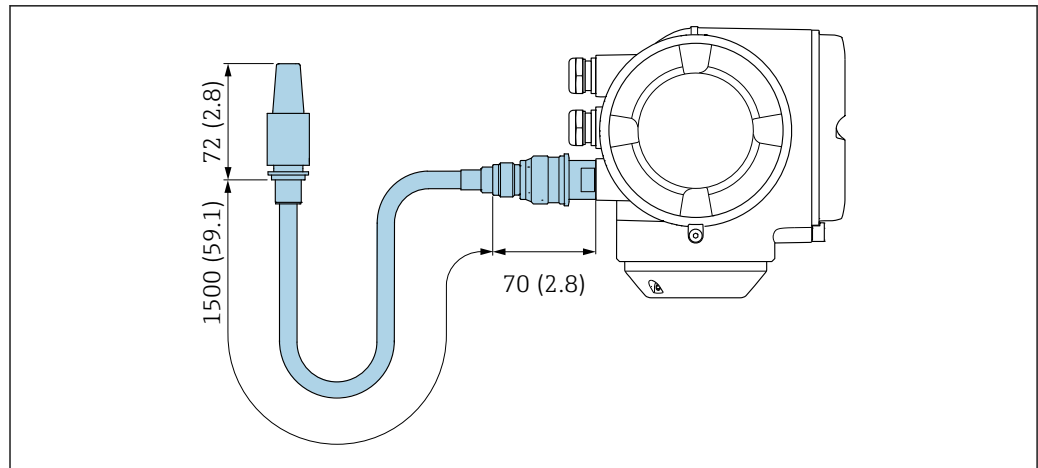

A0033597

38 Engineering unit mm (in)

Dimensions in US units

Housing of Proline 500 – digital transmitter

Non-hazardous area or hazardous area: Zone 2; Class I, Division 2

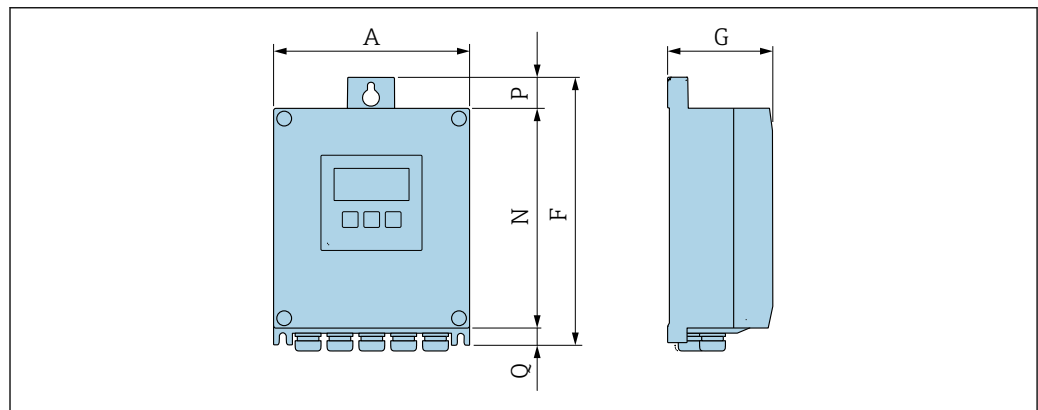

A0033789

Order code for "Transmitter housing", option A "Aluminum, coated" and order code for "Integrated ISEM electronics", option A "Sensor"

A [in]	F [in]	G [in]	N [in]	P [in]	Q [in]
6.57	9.13	3.15	7.36	0.94	0.83

Order code for "Transmitter housing", option D "Polycarbonate" and order code for "Integrated ISEM electronics", option A "Sensor"

A [in]	F [in]	G [in]	N [in]	P [in]	Q [in]
6.97	9.21	3.54	7.76	0.67	0.87

Housing of Proline 500 transmitter

Hazardous area: Zone 2; Class I, Division 2 or Zone 1; Class I, Division 1

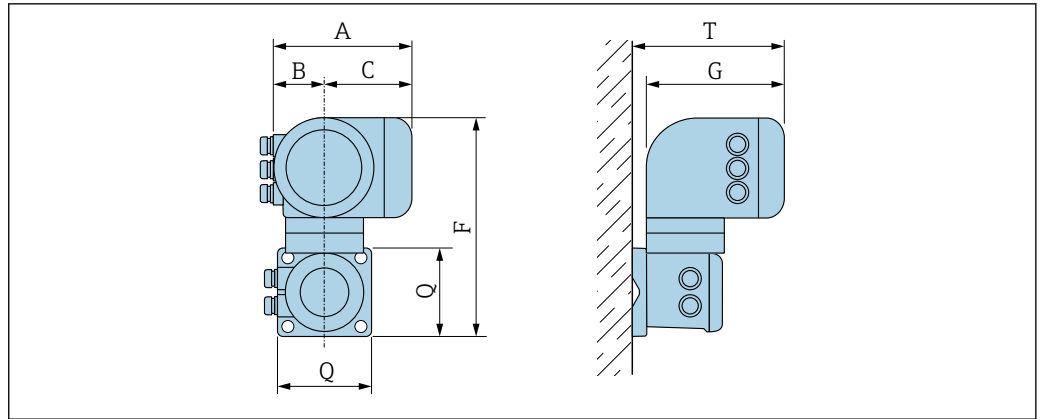

A003378B

Order code for "Transmitter housing", option A "Aluminum, coated" and order code for "Integrated ISEM electronics", option B "Transmitter"

A [in]	B [in]	C [in]	F [in]	G [in]	Q [in]	T [in]
7.40	3.35	4.06	12.5	8.54	5.12	9.41

Order code for "Transmitter housing", option L "Cast, stainless" and order code for "Integrated ISEM electronics", option B "Transmitter"

A [in]	B [in]	C [in]	F [in]	G [in]	Q [in]	T [in]
7.40	3.35	4.06	11.6	8.54	5.12	9.41

Sensor connection housing

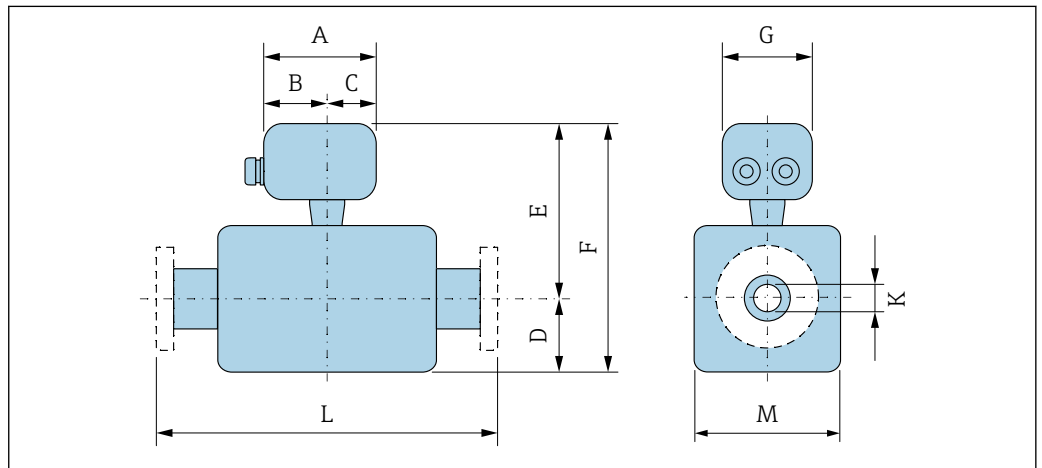

A003378A

Order code for "Sensor connection housing", option A "Aluminum, coated"

DN [in]	A ¹⁾ [in]	B [in]	C [in]	D [in]	E [in]	F [in]	G [in]	K [in]	L [in]	M [in]
3/8	5.83	3.70	2.13	4.25	10.3	14.5	5.35	0.211	²⁾	3.62
1/2	5.83	3.70	2.13	4.25	10.3	14.5	5.35	0.33	²⁾	3.62
1	5.83	3.70	2.13	4.76	10.3	15.0	5.35	0.47	²⁾	3.62

DN [in]	A ¹⁾ [in]	B [in]	C [in]	D [in]	E [in]	F [in]	G [in]	K [in]	L [in]	M [in]
1½	5.83	3.70	2.13	6.81	11.2	18.0	5.35	0.69	²⁾	5.20
2	5.83	3.70	2.13	9.49	11.7	21.1	5.35	1.02	²⁾	6.57

- 1) Depending on the cable gland used: values up to +1.18 in
 2) Dependent on the respective process connection

Order code for "Sensor connection housing", option B "Stainless"

DN [in]	A ¹⁾ [in]	B ¹⁾ [in]	C [in]	D [in]	E [in]	F [in]	G [in]	K [in]	L [in]	M [in]
$\frac{3}{8}$	5.39	3.07	2.32	4.25	10.1	14.4	5.28	0.211	²⁾	3.62
$\frac{1}{2}$	5.39	3.07	2.32	4.25	10.1	14.4	5.28	0.33	²⁾	3.62
1	5.39	3.07	2.32	4.76	10.1	14.9	5.28	0.47	²⁾	3.62
1½	5.39	3.07	2.32	6.81	11.1	17.9	5.28	0.69	²⁾	5.20
2	5.39	3.07	2.32	9.49	11.5	21.0	5.28	1.02	²⁾	6.57

- 1) Depending on the cable gland used: values up to +1.18 in
 2) Dependent on the respective process connection

Order code for "Sensor connection housing", option C "Ultra-compact hygienic, stainless"

DN [in]	A ¹⁾ [in]	B ¹⁾ [in]	C [in]	D [in]	E [in]	F [in]	G [in]	K [in]	L [in]	M [in]
$\frac{3}{8}$	4.88	2.68	2.20	4.25	10.1	14.4	4.41	0.21	²⁾	3.62
$\frac{1}{2}$	4.88	2.68	2.20	4.25	10.1	14.4	4.41	0.33	²⁾	3.62
1	4.88	2.68	2.20	4.76	10.1	14.9	4.41	0.47	²⁾	3.62
1½	4.88	2.68	2.20	6.81	11.1	17.9	4.41	0.69	²⁾	5.20
2	4.88	2.68	2.20	9.49	11.5	21.0	4.41	1.02	²⁾	6.57

- 1) Depending on the cable gland used: values up to +1.18 in
 2) Dependent on the respective process connection

Order code for "Sensor connection housing", option L "Cast, stainless"

DN [in]	A ¹⁾ [in]	B [in]	C [in]	D [in]	E [in]	F [in]	G [in]	K [in]	L [in]	M [in]
$\frac{3}{8}$	5.71	3.39	2.32	4.25	11.18	15.43	5.35	0.211	²⁾	3.62
$\frac{1}{2}$	5.71	3.39	2.32	4.25	11.18	15.43	5.35	0.33	²⁾	3.62
1	5.71	3.39	2.32	4.76	11.18	15.94	5.35	0.47	²⁾	3.62
1½	5.71	3.39	2.32	6.81	12.13	18.94	5.35	0.69	²⁾	5.20
2	5.71	3.39	2.32	9.49	12.56	22.05	5.35	1.02	²⁾	6.57

- 1) Depending on the cable gland used: values up to +1.18 in
 2) Dependent on the respective process connection

Flange connections

Fixed flange ASME B16.5

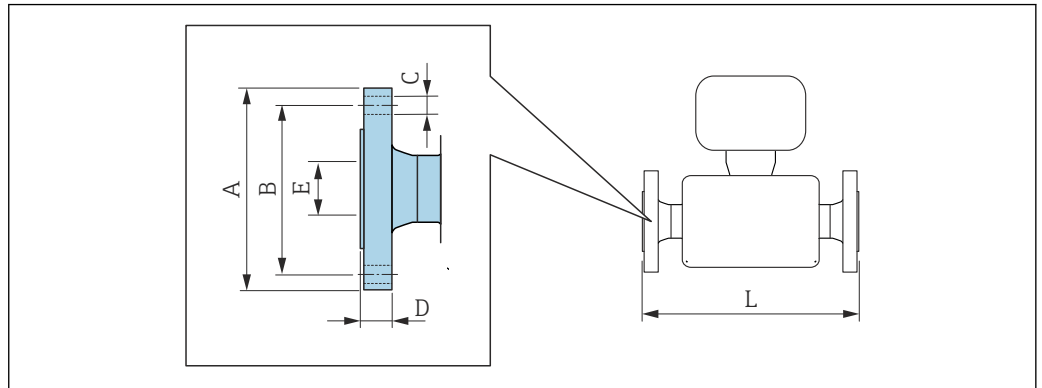

i Length tolerance for dimension L in inch:
+0.06 / -0.08

Flange according to ASME B16.5: CI 150						
1.4404 (316/316L)						
<i>Order code for "Process connection", option AAW</i>						
DN [in]	A [in]	B [in]	C [in]	D [in]	E [in]	L [in]
$\frac{3}{8}$ ¹⁾	3.54	2.37	4 × Ø0.62	0.50	0.62	13.23
$\frac{1}{2}$	3.54	2.37	4 × Ø0.62	0.50	0.62	17.32
1	4.33	3.13	4 × Ø0.62	0.59	1.05	22.83
1½	4.92	3.87	4 × Ø0.62	0.69	1.61	31.26
2	5.91	4.75	4 × Ø0.75	0.93	2.07	42.17

Surface roughness (flange): Ra 125 to 248 µin

1) DN $\frac{3}{8}$ " with DN $\frac{1}{2}$ " flanges as standard

Flange according to ASME B16.5: CI 300						
1.4404 (316/316L)						
<i>Order code for "Process connection", option ABW</i>						
DN [in]	A [in]	B [in]	C [in]	D [in]	E [in]	L [in]
$\frac{3}{8}$ ¹⁾	3.74	2.63	4 × Ø0.62	0.56	0.62	13.23
$\frac{1}{2}$	3.74	2.63	4 × Ø0.62	0.56	0.62	17.32
1	4.92	3.50	4 × Ø0.75	0.69	1.05	22.83
1½	6.10	4.50	4 × Ø0.88	0.81	1.61	31.26
2	6.50	5.00	8 × Ø0.75	0.93	2.07	42.17

Surface roughness (flange): Ra 125 to 248 µin

1) DN $\frac{3}{8}$ " with DN $\frac{1}{2}$ " flanges as standard

Accessories

Rinse connections

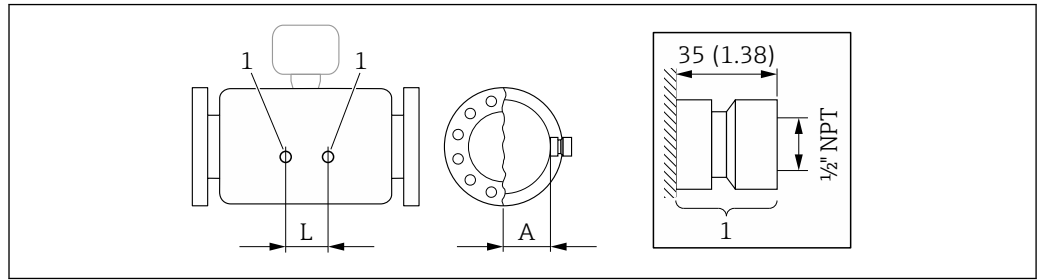

A0029969

1 Connection nipple for purge connections: order code for "Sensor options", option CH "Purge connection"

DN [in]	A [in]	L [in]
3/8	1.85	4.33
1/2	1.85	8.03
1	1.85	13.7
1 1/2	2.64	20.71
2	3.33	30.04

Protective cover

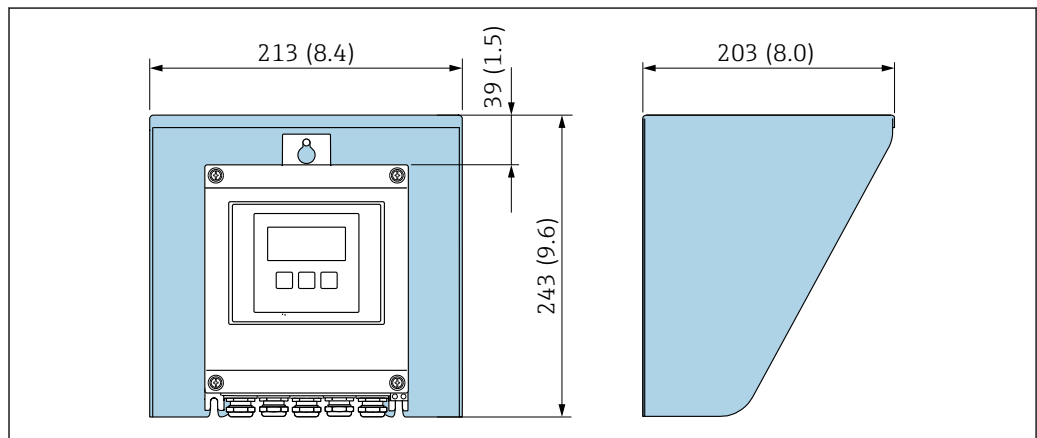

A0029552

39 Weather protection cover for Proline 500 - digital

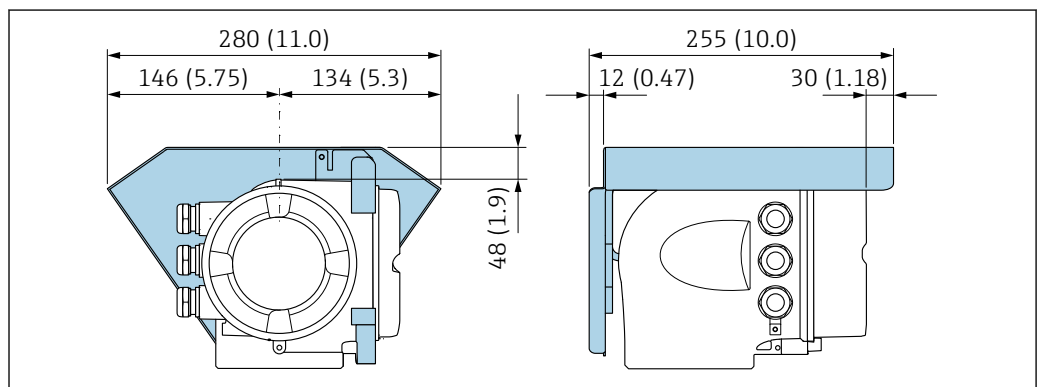

A0029553

40 Weather protection cover for Proline 500

External WLAN antenna

 The external WLAN antenna is not suitable for use in hygienic applications.

Proline 500 – digital

External WLAN antenna mounted on device

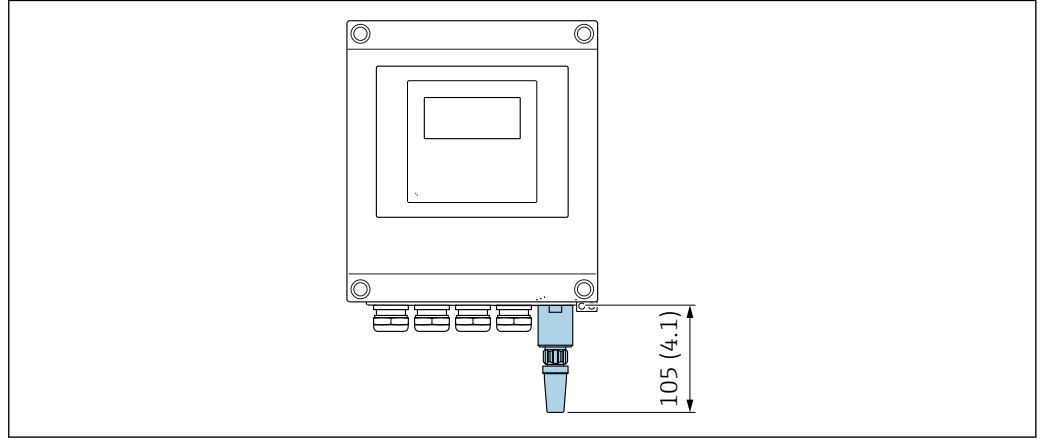

A0033607

 41 Engineering unit mm (in)

External WLAN antenna mounted with cable

The external WLAN antenna can be mounted separately from the transmitter if the transmission/reception conditions at the transmitter mounting location are poor.

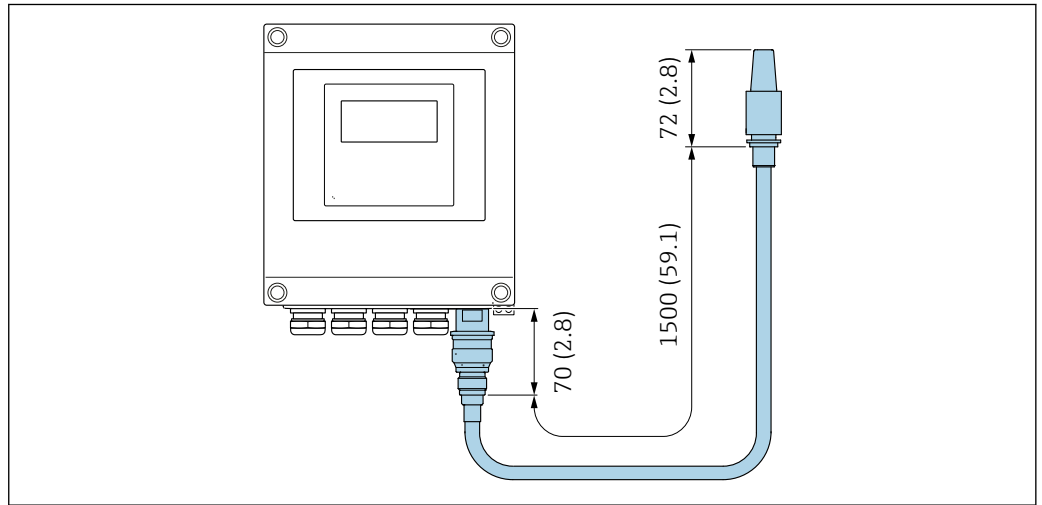

A0033606

 42 Engineering unit mm (in)

Proline 500

External WLAN antenna mounted on device

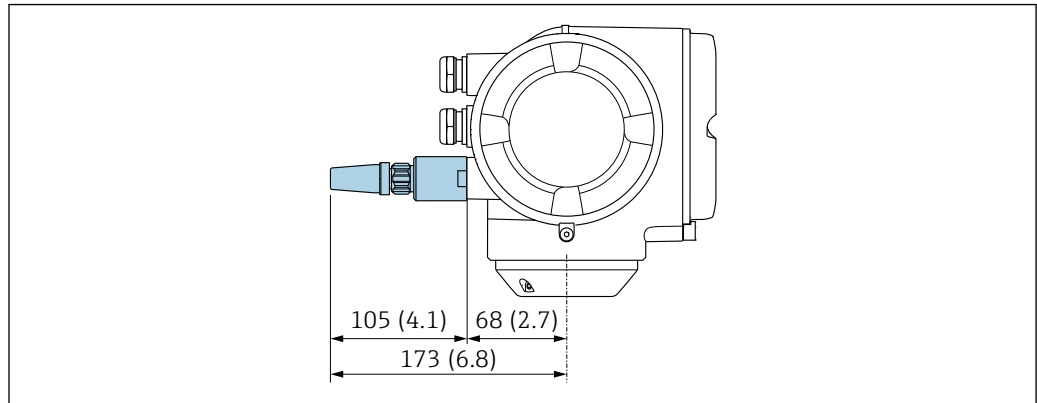

A0028923

43 Engineering unit mm (in)

External WLAN antenna mounted with cable

The external WLAN antenna can be mounted separately from the transmitter if the transmission/reception conditions at the transmitter mounting location are poor.

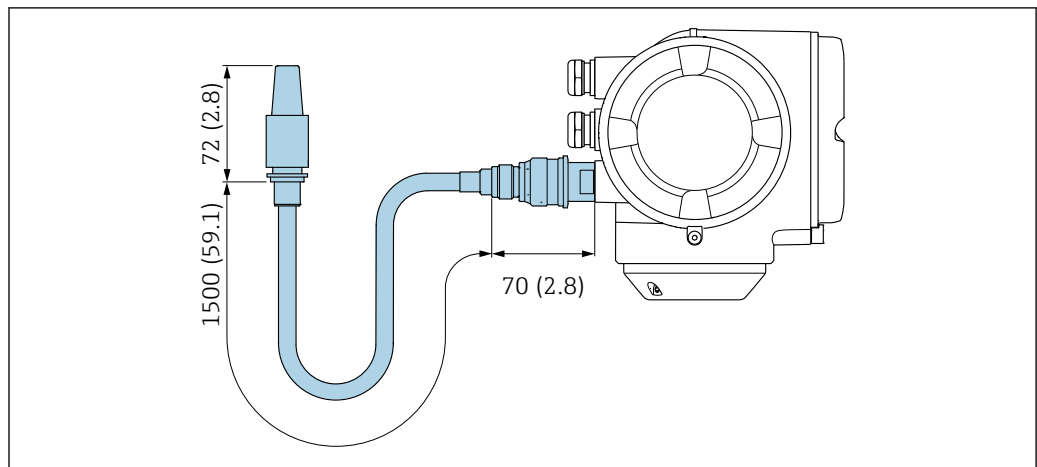

A0033597

44 Engineering unit mm (in)

Weight

All values (weight exclusive of packaging material) refer to devices with EN/DIN PN 40 flanges.

Transmitter

- Proline 500 – digital polycarbonate: 1.4 kg (3.1 lbs)
- Proline 500 – digital aluminum: 2.4 kg (5.3 lbs)
- Proline 500 aluminum: 6.5 kg (14.3 lbs)
- Proline 500 cast, stainless: 15.6 kg (34.4 lbs)

Sensor

- Sensor with aluminum connection housing version: see the information in the following table
- Cast connection housing version, stainless: +3.7 kg (+8.2 lbs)

Weight in SI units

DN [mm]	Weight [kg]
8	10
15	11
25	17

DN [mm]	Weight [kg]
40	34
50	67

Weight in US units

DN [in]	Weight [lbs]
3/8	22
1/2	24
1	37
1 1/2	75
2	148

Materials

Transmitter housing

Housing of Proline 500 – digital transmitter

Order code for "Transmitter housing":

- Option **A** "Aluminum coated": aluminum, AlSi10Mg, coated
- Option **D** "Polycarbonate": polycarbonate

Housing of Proline 500 transmitter

Order code for "Transmitter housing":

- Option **A** "Aluminum coated": aluminum, AlSi10Mg, coated
- Option **L** "Cast, stainless": cast, stainless steel, 1.4409 (CF3M) similar to 316L

Window material

Order code for "Transmitter housing":

- Option **A** "Aluminum, coated": glass
- Option **D** "Polycarbonate": plastic
- Option **L** "Cast, stainless": glass

Sensor connection housing

Order code for "Sensor connection housing":

- Option **A** "Aluminum coated": aluminum, AlSi10Mg, coated
- Option **B** "Stainless":
 - Stainless steel 1.4301 (304)
 - Optional: Order code for "Sensor feature", option **CC** "Hygienic version, for maximum corrosion resistance": stainless steel, 1.4404 (316L)
- Option **C** "Ultra-compact, stainless":
 - Stainless steel 1.4301 (304)
 - Optional: Order code for "Sensor feature", option **CC** "Hygienic version, for maximum corrosion resistance": stainless steel, 1.4404 (316L)
- Option **L** "Cast, stainless": 1.4409 (CF3M) similar to 316L

Cable entries/cable glands

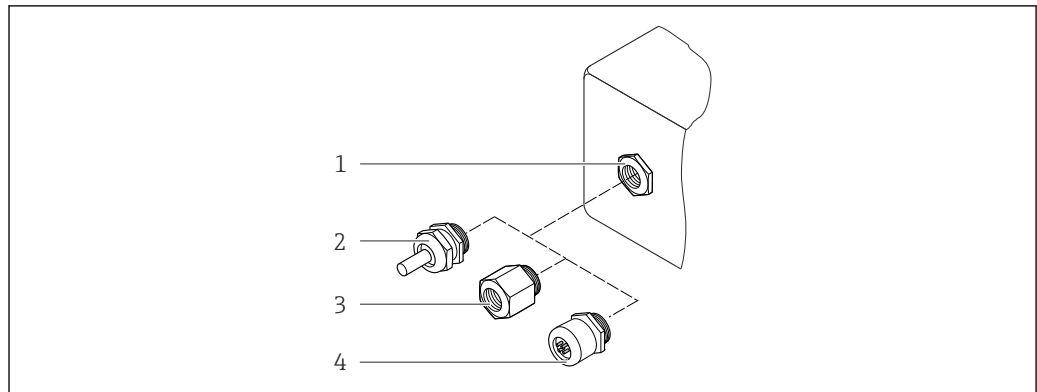

A0028352

45 Possible cable entries/cable glands

- 1 Female thread M20 × 1.5
- 2 Cable gland M20 × 1.5
- 3 Adapter for cable entry with internal thread G ½" or NPT ½"
- 4 Device plugs

Cable entries and adapters	Material
Cable gland M20 × 1.5	Plastic
<ul style="list-style-type: none"> ■ Adapter for cable entry with internal thread G ½" ■ Adapter for cable entry with internal thread NPT ½" <p>i Only available for certain device versions:</p> <ul style="list-style-type: none"> ■ Order code for "Transmitter housing": <ul style="list-style-type: none"> – Option A "Aluminum, coated" – Option D "Polycarbonate" ■ Order code for "Sensor connection housing": <ul style="list-style-type: none"> – Proline 500 – digital: <ul style="list-style-type: none"> Option A "Aluminum coated" Option B "Stainless" Option L "Cast, stainless" – Proline 500: <ul style="list-style-type: none"> Option B "Stainless" Option L "Cast, stainless" 	Nickel-plated brass
<ul style="list-style-type: none"> ■ Adapter for cable entry with internal thread G ½" ■ Adapter for cable entry with internal thread NPT ½" <p>i Only available for certain device versions:</p> <ul style="list-style-type: none"> ■ Order code for "Transmitter housing": <ul style="list-style-type: none"> Option L "Cast, stainless" ■ Order code for "Sensor connection housing": <ul style="list-style-type: none"> Option L "Cast, stainless" 	Stainless steel, 1.4404 (316L)
Adapter for device plug <p>i Device plug for digital communication: Only available for certain device versions → 29.</p>	Stainless steel, 1.4404 (316L)

Device plug

Electrical connection	Material
Plug M12x1	<ul style="list-style-type: none"> ■ Socket: Stainless steel, 1.4404 (316L) ■ Contact housing: Polyamide ■ Contacts: Gold-plated brass

Connecting cable

Connecting cable for sensor - Proline 500 – digital transmitter

PVC cable with copper shield

Connecting cable for sensor - Proline 500 transmitter

- Standard cable: PVC cable with copper shield
- Reinforced cable: PVC cable with copper shield and additional steel wire braided jacket

 UV rays can impair the cable outer sheath. Protect the cable from exposure to sun as much as possible.

Sensor housing



- Acid and alkali-resistant outer surface
- Stainless steel 1.4301 (304)

Measuring tubes

- Zirconium 702/R 60702
- Tantalum 2.5W

Process connections

- Stainless steel, 1.4301 (304); wetted parts: zirconium 702, tantalum
- Flanges according to EN 1092-1 (DIN 2501) / according to ASME B16.5 / according to JIS B2220

 Available process connections →  79

Seals

Welded process connections without internal seals

Accessories

Protective cover

Stainless steel, 1.4404 (316L)

External WLAN antenna

- Antenna: ASA plastic (acrylic ester-styrene-acrylonitrile) and nickel-plated brass
- Adapter: Stainless steel and nickel-plated brass
- Cable: Polyethylene
- Plug: Nickel-plated brass
- Angle bracket: Stainless steel

Process connections

Fixed flange connections:
– EN 1092-1 (DIN 2501) flange
– EN 1092-1 (DIN 2512N) flange
– ASME B16.5 flange
– JIS B2220 flange

 Process connection materials →  79

Surface roughness

All data relate to parts in contact with fluid. The following surface roughness quality can be ordered.
Not polished

Operability

Operating concept

Operator-oriented menu structure for user-specific tasks

- Commissioning
- Operation
- Diagnostics
- Expert level

Fast and safe commissioning

- Guided menus ("Make-it-run" wizards) for applications
- Menu guidance with brief descriptions of the individual parameter functions
- Device access via Web server or SmartBlue app →  100
- WLAN access to the device via mobile handheld terminal, tablet or smart phone

Reliable operation

- Operation in local language →  80
- Uniform operating philosophy applied to device and operating tools
- If replacing electronic modules, transfer the device configuration via the integrated memory (HistoROM backup) which contains the process and measuring device data and the event logbook. No need to reconfigure.

Efficient diagnostics increase measurement availability

- Troubleshooting measures can be called up via the device and in the operating tools
- Diverse simulation options, logbook for events that occur and optional line recorder functions

Languages

Can be operated in the following languages:

- Via local operation
English, German, French, Spanish, Italian, Dutch, Portuguese, Polish, Russian, Turkish, Chinese, Japanese, Korean, Bahasa (Indonesian), Vietnamese, Czech, Swedish
- Via Web browser
English, German, French, Spanish, Italian, Dutch, Portuguese, Polish, Russian, Turkish, Chinese, Japanese, Korean, Bahasa (Indonesian), Vietnamese, Czech, Swedish
- Via "FieldCare", "DeviceCare" operating tool: English, German, French, Spanish, Italian, Chinese, Japanese

Local operation

Via display module

Two display modules are available:

- Order code for "Display; operation", option F "4-line, illuminated, graphic display; touch control"
- Order code for "Display; operation", option G "4-line, illuminated, graphic display; touch control + WLAN"

 Information about WLAN interface →  87

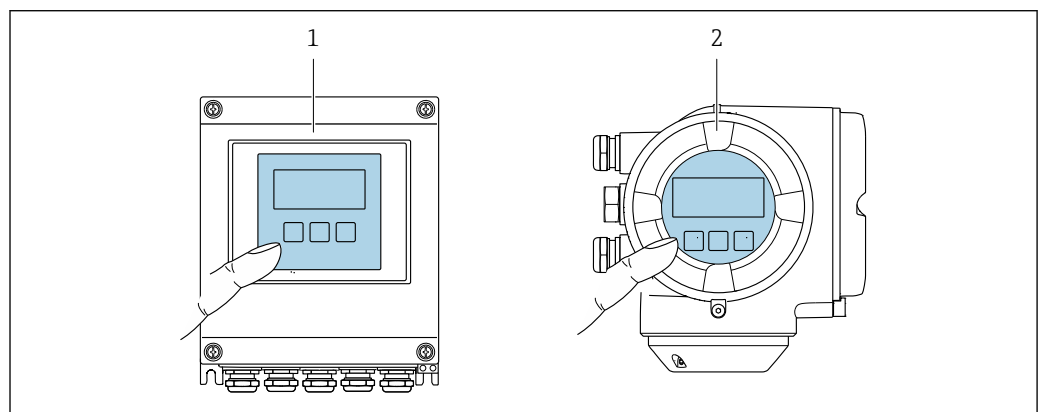

A0028232

 46 Operation with touch control

- 1 Proline 500 – digital
- 2 Proline 500

Display elements

- 4-line, illuminated, graphic display
- White background lighting; switches to red in event of device errors
- Format for displaying measured variables and status variables can be individually configured
- Permitted ambient temperature for the display: -20 to +60 °C (-4 to +140 °F)
The readability of the display may be impaired at temperatures outside the temperature range.

Operating elements

- External operation via touch control (3 optical keys) without opening the housing: ⊕, ⊖, ⊞
- Operating elements also accessible in the various zones of the hazardous area

Remote operation

Via HART protocol

This communication interface is available in device versions with a HART output.

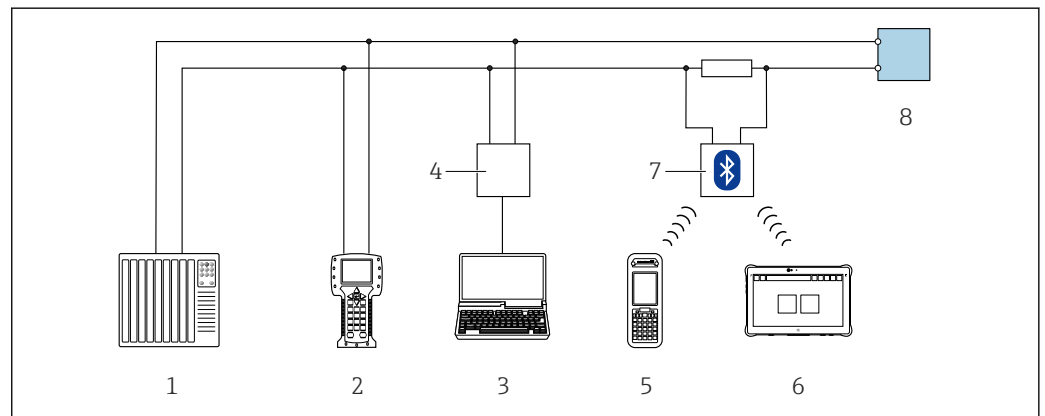

47 Options for remote operation via HART protocol (active)

- 1 Control system (e.g. PLC)
- 2 Field Communicator 475
- 3 Computer with Web browser (e.g. Internet Explorer) for access to the integrated device Web server or computer with an operating tool (e.g. FieldCare, DeviceCare, AMS Device Manager, SIMATIC PDM) with COM DTM "CDI Communication TCP/IP"
- 4 Commubox FXA195 (USB)
- 5 Field Xpert SFX350 or SFX370
- 6 Field Xpert SMT70
- 7 VIATOR Bluetooth modem with connecting cable
- 8 Transmitter

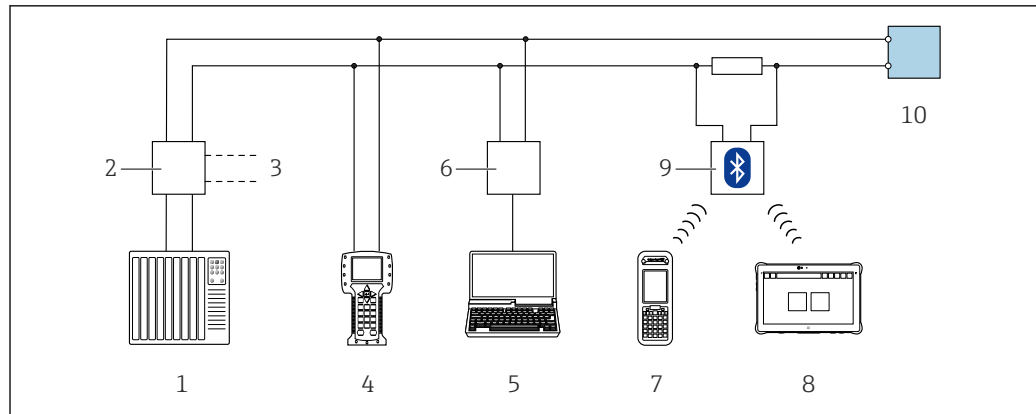

A0028746

48 Options for remote operation via HART protocol (passive)

- 1 Control system (e.g. PLC)
- 2 Transmitter power supply unit, e.g. RN221N (with communication resistor)
- 3 Connection for Commubox FXA195 and Field Communicator 475
- 4 Field Communicator 475
- 5 Computer with Web browser (e.g. Internet Explorer) for access to the integrated device Web server or computer with an operating tool (e.g. FieldCare, DeviceCare, AMS Device Manager, SIMATIC PDM) with COM DTM "CDI Communication TCP/IP"
- 6 Commubox FXA195 (USB)
- 7 Field Xpert SFX350 or SFX370
- 8 Field Xpert SMT70
- 9 VIATOR Bluetooth modem with connecting cable
- 10 Transmitter

Via FOUNDATION Fieldbus network

This communication interface is available in device versions with FOUNDATION Fieldbus.

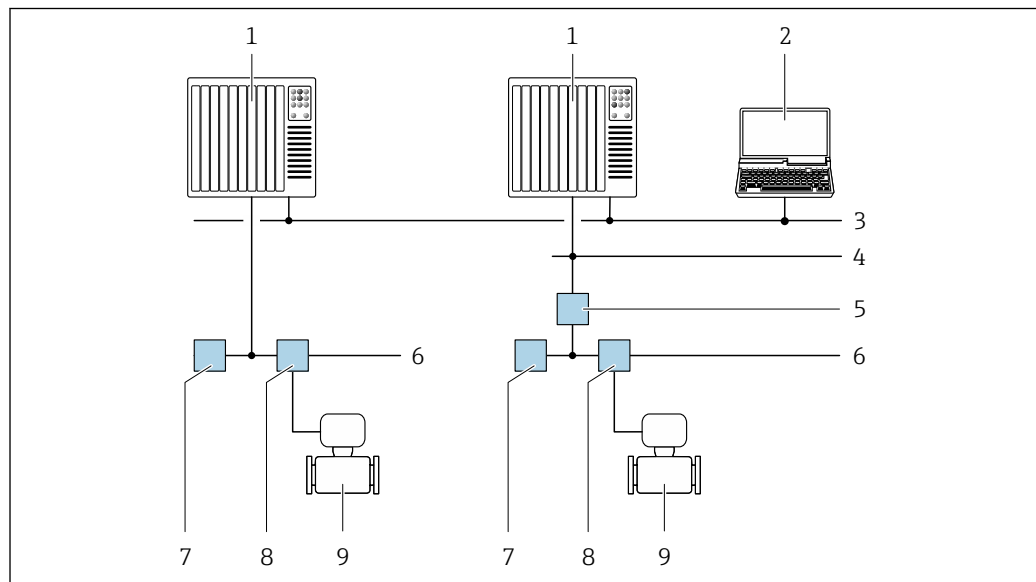

A0028837

49 Options for remote operation via FOUNDATION Fieldbus network

- 1 Automation system
- 2 Computer with FOUNDATION Fieldbus network card
- 3 Industry network
- 4 High Speed Ethernet FF-HSE network
- 5 Segment coupler FF-HSE/FF-H1
- 6 FOUNDATION Fieldbus FF-H1 network
- 7 Power supply FF-H1 network
- 8 T-box
- 9 Measuring device

Via PROFIBUS DP network

This communication interface is available in device versions with PROFIBUS DP.

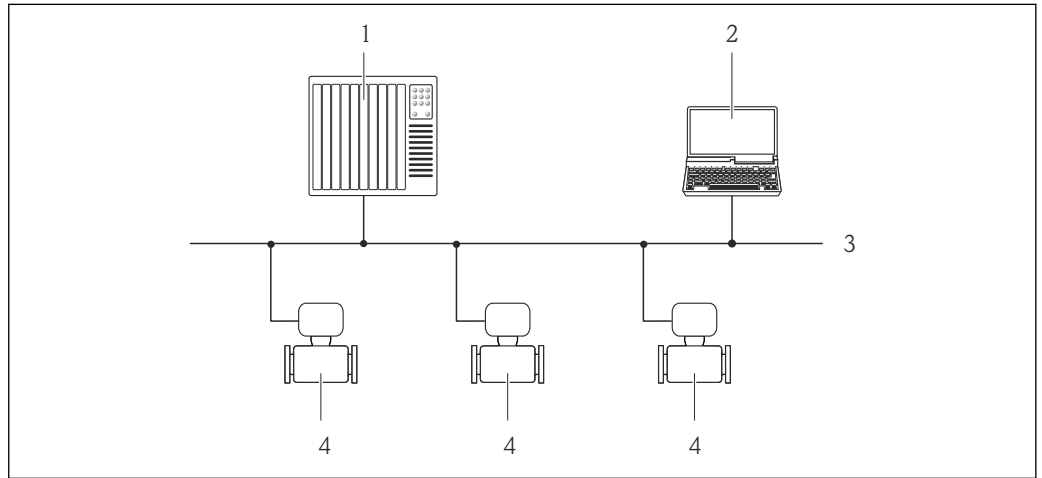

A0020903

50 Options for remote operation via PROFIBUS DP network

- 1 Automation system
- 2 Computer with PROFIBUS network card
- 3 PROFIBUS DP network
- 4 Measuring device

Via PROFIBUS PA network

This communication interface is available in device versions with PROFIBUS PA.

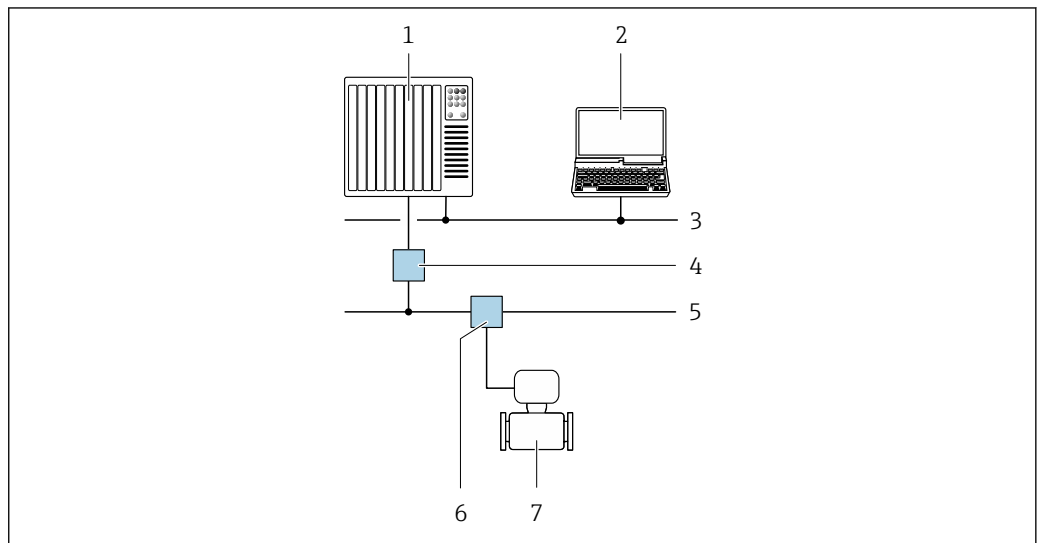

A0028838

51 Options for remote operation via PROFIBUS PA network

- 1 Automation system
- 2 Computer with PROFIBUS network card
- 3 PROFIBUS DP network
- 4 Segment coupler PROFIBUS DP/PA
- 5 PROFIBUS PA network
- 6 T-box
- 7 Measuring device

Via Modbus RS485 protocol

This communication interface is available in device versions with a Modbus-RS485 output.

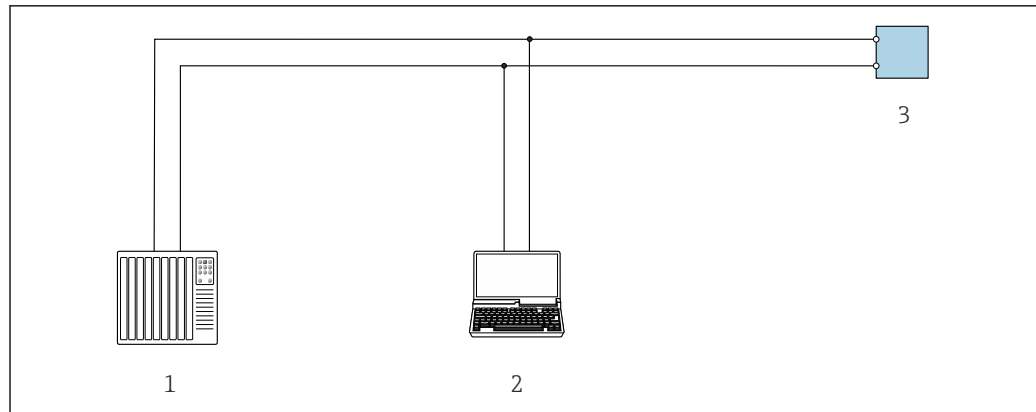

A0029437

52 Options for remote operation via Modbus-RS485 protocol (active)

- 1 Control system (e.g. PLC)
- 2 Computer with Web browser (e.g. Internet Explorer) for accessing the integrated device Web server or with operating tool (e.g. FieldCare, DeviceCare) with COM DTM "CDI Communication TCP/IP" or Modbus DTM
- 3 Transmitter

Via EtherNet/IP network

This communication interface is available in device versions with EtherNet/IP.

Star topology

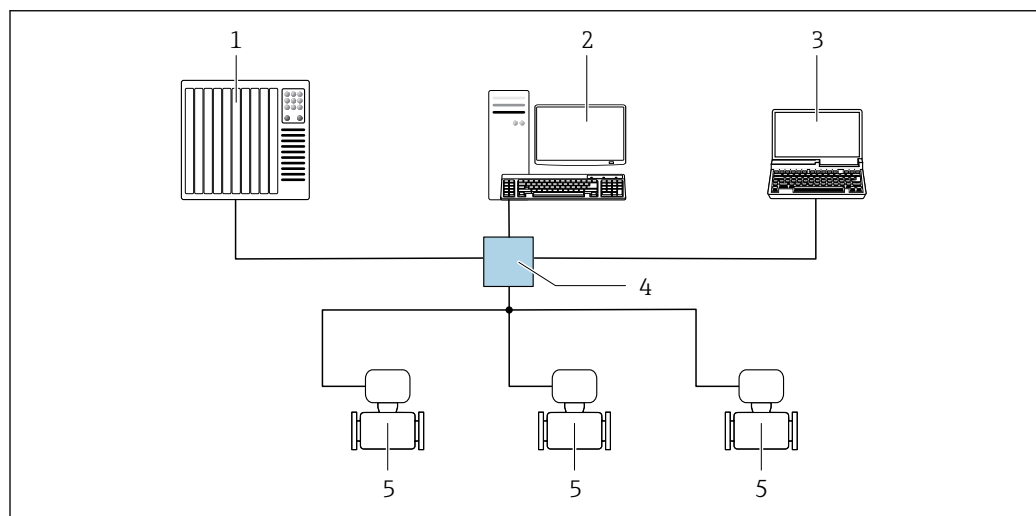

A0032078

53 Options for remote operation via EtherNet/IP network: star topology

- 1 Automation system, e.g. "RSLogix" (Rockwell Automation)
- 2 Workstation for measuring device operation: with Custom Add-On Profile for "RSLogix 5000" (Rockwell Automation) or with Electronic Data Sheet (EDS)
- 3 Computer with Web browser (e.g. Internet Explorer) for accessing the integrated device Web server or computer with operating tool (e.g. FieldCare, DeviceCare) with COM DTM "CDI Communication TCP/IP"
- 4 Ethernet switch
- 5 Measuring device

Ring topology

The device is integrated via the terminal connection for signal transmission (output 1) and the service interface (CDI-RJ45).

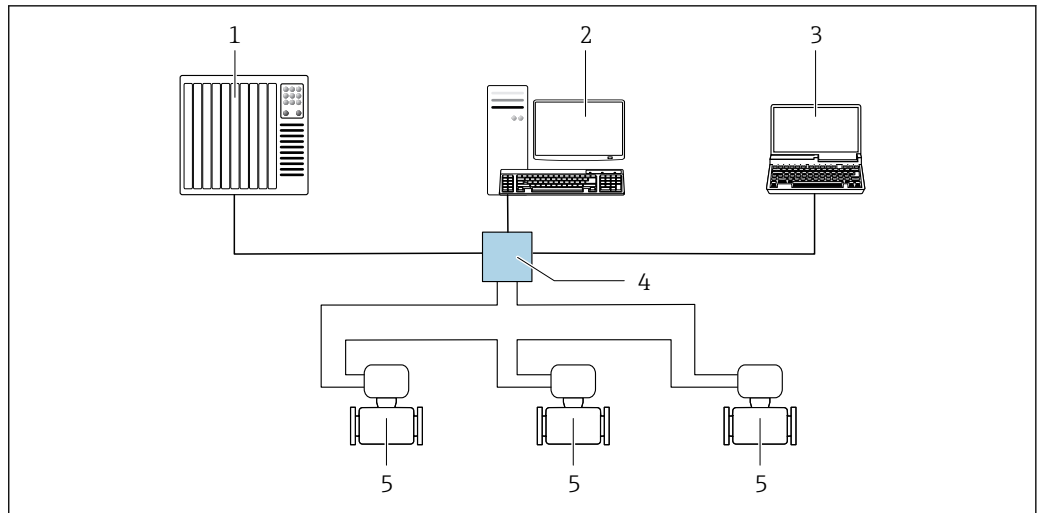

A0033725

54 Options for remote operation via EtherNet/IP network: ring topology

- 1 Automation system, e.g. "RSLogix" (Rockwell Automation)
- 2 Workstation for measuring device operation: with Custom Add-On Profile for "RSLogix 5000" (Rockwell Automation) or with Electronic Data Sheet (EDS)
- 3 Computer with Web browser (e.g. Internet Explorer) for accessing the integrated device Web server or computer with operating tool (e.g. FieldCare, DeviceCare) with COM DTM "CDI Communication TCP/IP"
- 4 Ethernet switch
- 5 Measuring device

Via PROFINET network

This communication interface is available in device versions with PROFINET.

Star topology

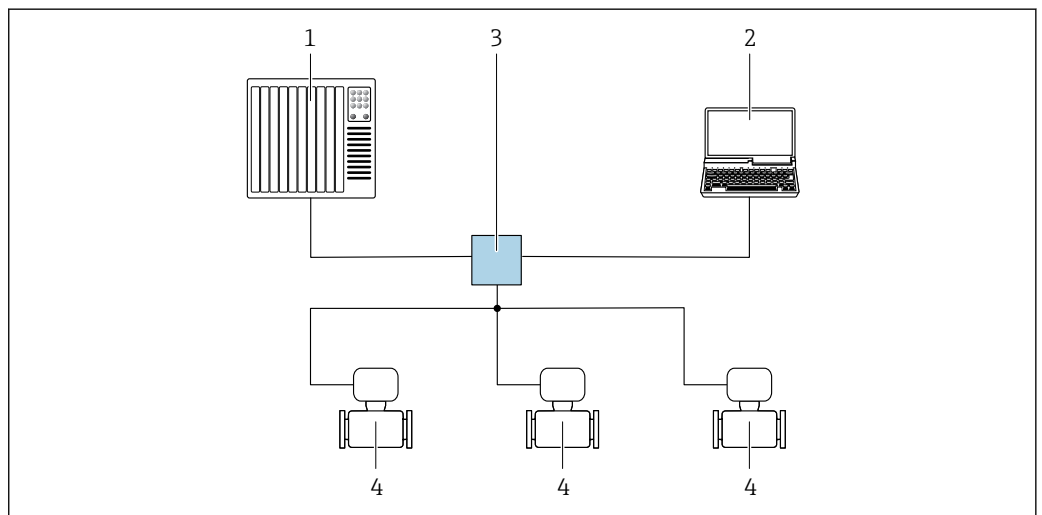

A0026545

55 Options for remote operation via PROFINET network: star topology

- 1 Automation system, e.g. Simatic S7 (Siemens)
- 2 Computer with Web browser (e.g. Internet Explorer) for accessing the integrated device Web server or computer with operating tool (e.g. FieldCare, DeviceCare, SIMATIC PDM) with COM DTM "CDI Communication TCP/IP"
- 3 Switch, e.g. Scalance X204 (Siemens)
- 4 Measuring device

Ring topology

This communication interface is available in device versions with PROFINET.

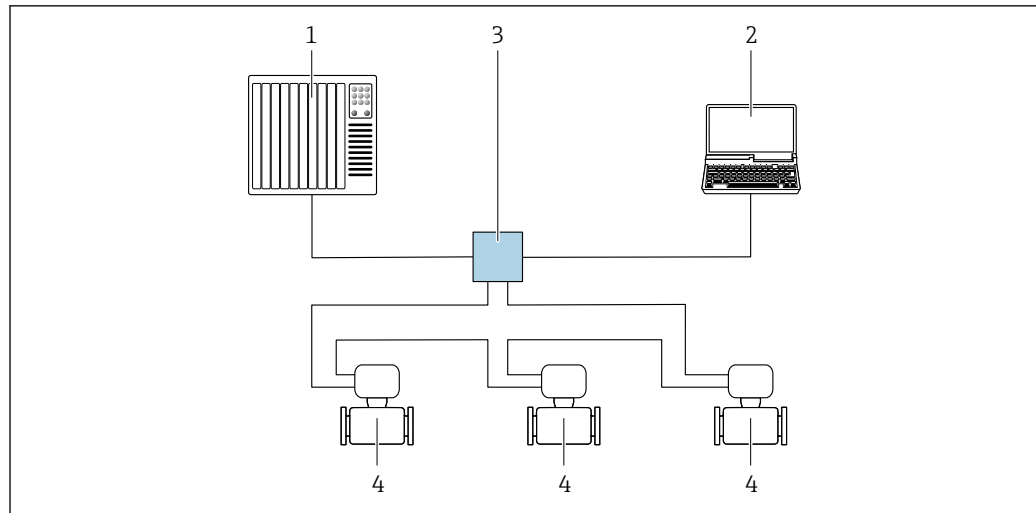

A0033719

56 Options for remote operation via PROFINET network: ring topology

- 1 Automation system, e.g. Simatic S7 (Siemens)
- 2 Computer with Web browser (e.g. Internet Explorer) for accessing the integrated device Web server or computer with operating tool (e.g. FieldCare, DeviceCare, SIMATIC PDM) with COM DTM "CDI Communication TCP/IP"
- 3 Switch, e.g. Scalance X204 (Siemens)
- 4 Measuring device

Service interface

Via service interface (CDI-RJ45)

A point-to-point connection can be established to configure the device onsite. With the housing open, the connection is established directly via the service interface (CDI-RJ45) of the device.

i An adapter for RJ45 and the M12 connector is optionally available:
Order code for "Accessories", option **NB**: "Adapter RJ45 M12 (service interface)"

The adapter connects the service interface (CDI-RJ45) to an M12 connector mounted in the cable entry. Therefore the connection to the service interface can be established via an M12 connector without opening the device.

Proline 500 – digital transmitter

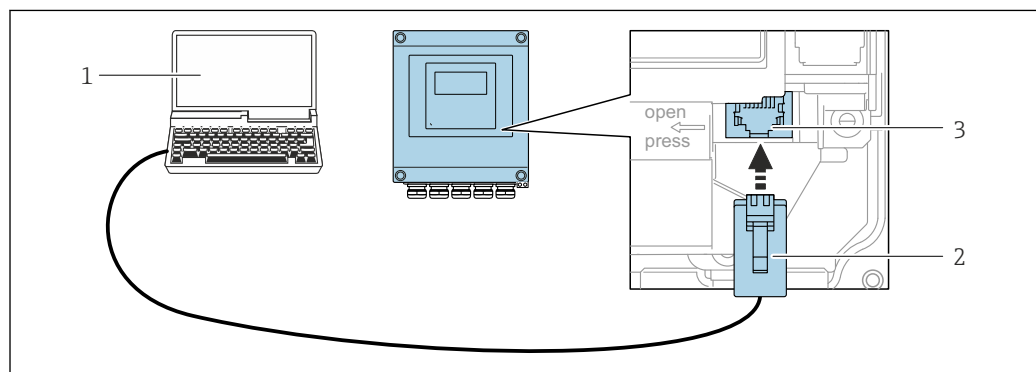

A0029163

57 Connection via service interface (CDI-RJ45)

- 1 Computer with Web browser (e.g. Microsoft Internet Explorer, Microsoft Edge) for accessing the integrated device Web server or with "FieldCare", "DeviceCare" operating tool with COM DTM "CDI Communication TCP/IP" or Modbus DTM
- 2 Standard Ethernet connecting cable with RJ45 connector
- 3 Service interface (CDI-RJ45) of the measuring device with access to the integrated Web server

Proline 500 transmitter

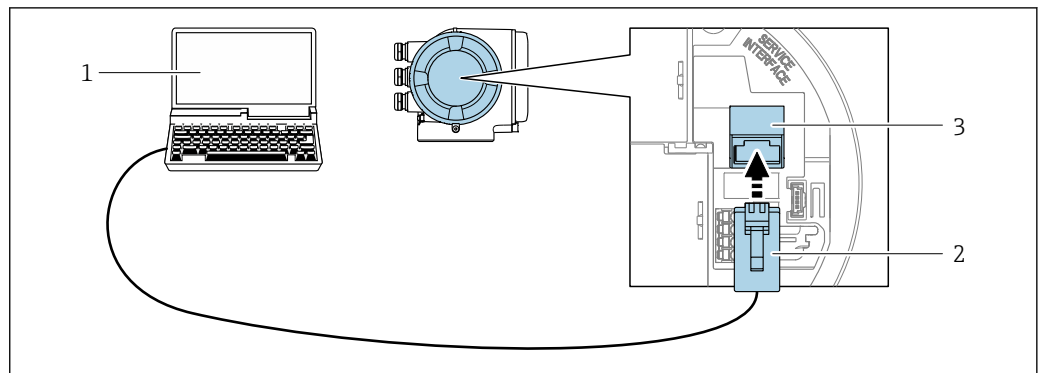

A0027563

58 Connection via service interface (CDI-RJ45)

- 1 Computer with Web browser (e.g. Microsoft Internet Explorer, Microsoft Edge) for accessing the integrated device Web server or with "FieldCare", "DeviceCare" operating tool with COM DTM "CDI Communication TCP/IP" or Modbus DTM
- 2 Standard Ethernet connecting cable with RJ45 connector
- 3 Service interface (CDI-RJ45) of the measuring device with access to the integrated Web server

Via WLAN interface

The optional WLAN interface is available on the following device version:

Order code for "Display; operation", option G "4-line, illuminated, graphic display; touch control + WLAN"

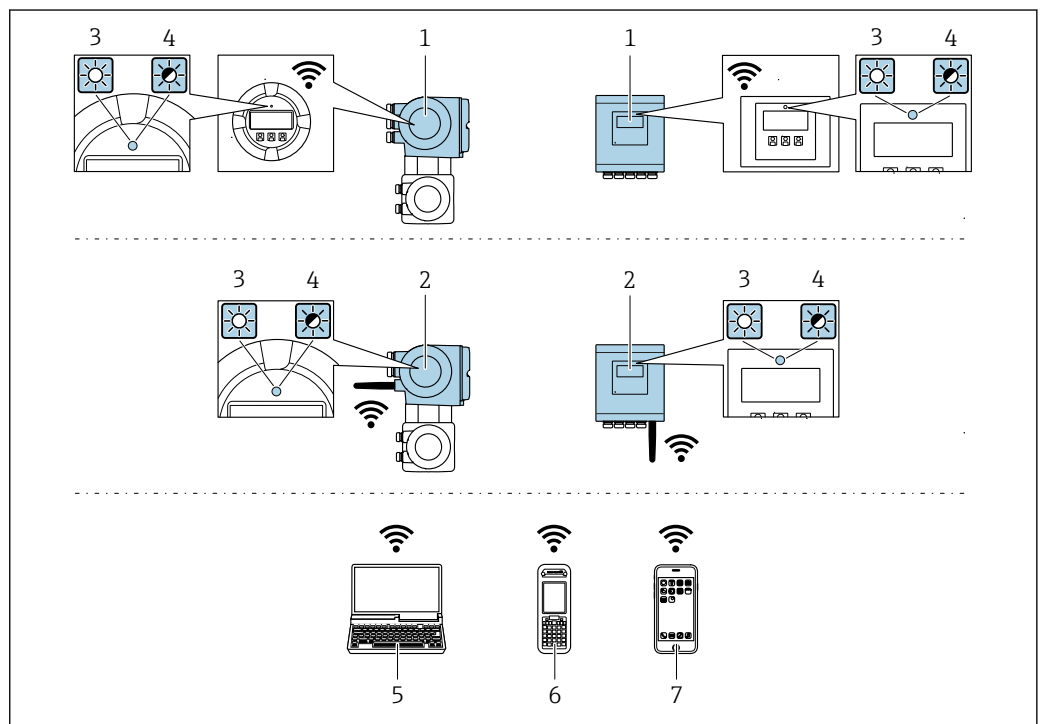

A0034569

- 1 Transmitter with integrated WLAN antenna
- 2 Transmitter with external WLAN antenna
- LED lit constantly: WLAN reception is enabled on measuring device
- 4 LED flashing: WLAN connection established between operating unit and measuring device
- 5 Computer with WLAN interface and Web browser (e.g. Microsoft Internet Explorer, Microsoft Edge) for accessing the integrated device Web server or with operating tool (e.g. FieldCare, DeviceCare)
- 6 Mobile handheld terminal with WLAN interface and Web browser (e.g. Microsoft Internet Explorer, Microsoft Edge) for accessing the integrated device Web server or operating tool (e.g. FieldCare, DeviceCare)
- 7 Smart phone or tablet (e.g. Field Xpert SMT70)

Function	WLAN: IEEE 802.11 b/g (2.4 GHz) <ul style="list-style-type: none"> ▪ Access point with DHCP server (default setting) ▪ Network
Encryption	WPA2-PSK AES-128 (in accordance with IEEE 802.11i)
Configurable WLAN channels	1 to 11
Degree of protection	IP67
Available antennas	<ul style="list-style-type: none"> ▪ Internal antenna ▪ External antenna (optional) In the event of poor transmission/reception conditions at the place of installation. Available as an accessory → 98. <p> Only one antenna active in each case!</p>
Max. range	50 m (164 ft)
Materials: External WLAN antenna	<ul style="list-style-type: none"> ▪ Antenna: ASA plastic (acrylic ester-styrene-acrylonitrile) and nickel-plated brass ▪ Adapter: Stainless steel and nickel-plated brass ▪ Cable: Polyethylene ▪ Connector: Nickel-plated brass ▪ Angle bracket: Stainless steel

Network integration

With the optional OPC-UA-Server application package, the device can be integrated into an Ethernet network via the service interface (CDI-RJ45 and WLAN) and communicate with OPC-UA clients. If the device is used in this way, IT security must be considered.

For permanent access to device data and for device configuration via the Web server, the device is incorporated directly in a network via the service interface (CDI-RJ45). In this way, the device can be accessed any time from the control station. The measured values are processed separately via the inputs and outputs through the automation system.

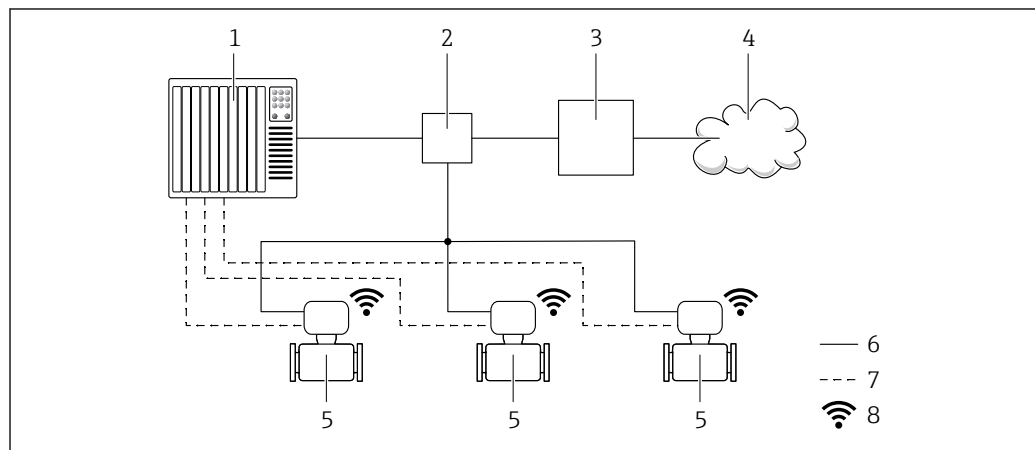

A0033618



- 1 Automation system, e.g. Simatic S7 (Siemens)
- 2 Ethernet switch
- 3 Edge Gateway
- 4 Cloud
- 5 Measuring device
- 6 Ethernet network
- 7 Measured values via inputs and outputs
- 8 Optional WLAN interface

 The optional WLAN interface is available on the following device version:
Order code for "Display; operation", option **G** "4-line, illuminated, graphic display; touch control + WLAN"

 Special Documentation for the OPC-UA-Server application package → 102.

Supported operating tools

Different operating tools can be used for local or remote access to the measuring device. Depending on the operating tool used, access is possible with different operating units and via a variety of interfaces.

Supported operating tools	Operating unit	Interface	Additional information
Web browser	Notebook, PC or tablet with Web browser	<ul style="list-style-type: none"> ■ CDI-RJ45 service interface ■ WLAN interface ■ Ethernet-based fieldbus (EtherNet/IP, PROFINET) 	Special Documentation for device →  102
DeviceCare SFE100	Notebook, PC or tablet with Microsoft Windows system	<ul style="list-style-type: none"> ■ CDI-RJ45 service interface ■ WLAN interface ■ Fieldbus protocol 	→  100
FieldCare SFE500	Notebook, PC or tablet with Microsoft Windows system	<ul style="list-style-type: none"> ■ CDI-RJ45 service interface ■ WLAN interface ■ Fieldbus protocol 	→  100
Device Xpert	Field Xpert SFX 100/350/370	HART and FOUNDATION Fieldbus fieldbus protocol	Operating Instructions BA01202S Device description files: Use update function of handheld terminal



Other operating tools based on FDT technology with a device driver such as DTM/iDTM or DD/EDD can be used for device operation. These operating tools are available from the individual manufacturers. Integration into the following operating tools, among others, is supported:

- FactoryTalk AssetCentre (FTAC) by Rockwell Automation → www.rockwellautomation.com
- Process Device Manager (PDM) by Siemens → www.siemens.com
- Asset Management Solutions (AMS) by Emerson → www.emersonprocess.com
- FieldCommunicator 375/475 by Emerson → www.emersonprocess.com
- Field Device Manager (FDM) by Honeywell → www.honeywellprocess.com
- FieldMate by Yokogawa → www.yokogawa.com
- PACTWare → www.pactware.com

The associated device description files are available at: www.endress.com → Downloads

Web server

Thanks to the integrated Web server, the device can be operated and configured via a Web browser and via a service interface (CDI-RJ45) or via a WLAN interface. The structure of the operating menu is the same as for the local display. In addition to the measured values, status information on the device is also displayed and allows the user to monitor the status of the device. Furthermore the device data can be managed and the network parameters can be configured.



A device that has a WLAN interface (can be ordered as an option) is required for the WLAN connection: order code for "Display; operation", option G "4-line, illuminated; touch control + WLAN". The device acts as an Access Point and enables communication by computer or a mobile handheld terminal.

Supported functions

Data exchange between the operating unit (such as a notebook for example) and the measuring device:

- Upload the configuration from the measuring device (XML format, configuration backup)
- Save the configuration to the measuring device (XML format, restore configuration)
- Export event list (.csv file)
- Export parameter settings (.csv file or PDF file, document the measuring point configuration)
- Export the Heartbeat verification log (PDF file, only available with the "Heartbeat Verification" application package)

- Flash firmware version for device firmware upgrade, for instance
- Download driver for system integration
- Visualize up to 1000 saved measured values (only available with the **Extended HistoROM** application package →  97)

 Web server special documentation →  102

HistoROM data management

The measuring device features HistoROM data management. HistoROM data management comprises both the storage and import/export of key device and process data, making operation and servicing far more reliable, secure and efficient.

 When the device is delivered, the factory settings of the configuration data are stored as a backup in the device memory. This memory can be overwritten with an updated data record, for example after commissioning.

Additional information on the data storage concept

There are different types of data storage units in which device data are stored and used by the device:

	Device memory	T-DAT	S-DAT
Available data	<ul style="list-style-type: none"> ▪ Event logbook such as diagnostic events for example ▪ Parameter data record backup ▪ Device firmware package ▪ Driver for system integration for exporting via Web server, e.g: <ul style="list-style-type: none"> - GSD for PROFIBUS DP - GSD for PROFIBUS PA - GSDML for PROFINET - EDS for EtherNet/IP - DD for FOUNDATION Fieldbus 	<ul style="list-style-type: none"> ▪ Measured value logging ("Extended HistoROM" order option) ▪ Current parameter data record (used by firmware at run time) ▪ Peakhold indicator (min/max values) ▪ Totalizer values 	<ul style="list-style-type: none"> ▪ Sensor data: nominal diameter etc. ▪ Serial number ▪ Calibration data ▪ Device configuration (e.g. SW options, fixed I/O or multi I/O)
Storage location	Fixed on the user interface board in the connection compartment	Attachable to the user interface board in the connection compartment	In the sensor plug in the transmitter neck part

Data backup

Automatic

- The most important device data (sensor and transmitter) are automatically saved in the DAT modules
- If the transmitter or measuring device is replaced: once the T-DAT containing the previous device data has been exchanged, the new measuring device is ready for operation again immediately without any errors
- If the sensor is replaced: once the sensor has been replaced, new sensor data are transferred from the S-DAT in the measuring device and the measuring device is ready for operation again immediately without any errors
- If exchanging the electronics module (e.g. I/O electronics module): Once the electronics module has been replaced, the software of the module is compared against the current device firmware. The module software is upgraded or downgraded where necessary. The electronics module is available for use immediately afterwards and no compatibility problems occur.

Manual

Additional parameter data record (complete parameter settings) in the integrated device memory HistoROM backup for:

- Data backup function
Backup and subsequent restoration of a device configuration in the device memory HistoROM backup
- Data comparison function
Comparison of the current device configuration with the device configuration saved in the device memory HistoROM backup

Data transfer

Manual

- Transfer of a device configuration to another device using the export function of the specific operating tool, e.g. with FieldCare, DeviceCare or Web server: to duplicate the configuration or to store in an archive (e.g. for backup purposes)
- Transmission of the drivers for system integration via Web server, e.g.:
 - GSD for PROFIBUS DP
 - GSD for PROFIBUS PA
 - GSDML for PROFINET
 - EDS for EtherNet/IP
 - DD for FOUNDATION Fieldbus

Event list

Automatic

- Chronological display of up to 20 event messages in the events list
- If the **Extended HistoROM** application package (order option) is enabled: up to 100 event messages are displayed in the events list along with a time stamp, plain text description and remedial measures
- The events list can be exported and displayed via a variety of interfaces and operating tools e.g. DeviceCare, FieldCare or Web server

Data logging

Manual

If the **Extended HistoROM** application package (order option) is enabled:

- Record up to 1 000 measured values via 1 to 4 channels
- User configurable recording interval
- Record up to 250 measured values via each of the 4 memory channels
- Export the measured value log via a variety of interfaces and operating tools e.g. FieldCare, DeviceCare or web server

Certificates and approvals



Currently available certificates and approvals can be called up via the product configurator.

CE mark

The device meets the legal requirements of the applicable EU Directives. These are listed in the corresponding EU Declaration of Conformity along with the standards applied.

Endress+Hauser confirms successful testing of the device by affixing to it the CE mark.

C-Tick symbol

The measuring system meets the EMC requirements of the "Australian Communications and Media Authority (ACMA)".

Ex approval

The measuring device is certified for use in hazardous areas and the relevant safety instructions are provided in the separate "Safety Instructions" (XA) document. Reference is made to this document on the nameplate.

The following devices have equipment protection level (EPL) Gb (Zone 1 in the measuring tube):

- Device versions with the order code for "Integrated ISEM electronics", option A and the order code for "Approval; transmitter; sensor", option BI, BJ, BM or BN.
- Device versions with the order code for "Integrated ISEM electronics", option B and the order code for "Approval; transmitter; sensor", option BA, BB, BC or BD.



The separate Ex documentation (XA) containing all the relevant explosion protection data is available from your Endress+Hauser sales center.

Proline 500 – digital

ATEX/IECEX

Currently, the following versions for use in hazardous areas are available:

Ex ia

Transmitter		Sensor	
Category	Type of protection	Category	Type of protection
II(1)G	[Ex ia] IIC	II1/2G	Ex ia IIC T6...T1 Gb Ex ia IIB T6...T1 Gb
II(1)G	[Ex ia] IIC	II2G	Ex ia IIC T6...T1 Gb Ex ia IIB T6...T1 Gb
II3(1)G	Ex ec [ia Ga] IIC T5...T4 Gc	II1/2G	Ex ia IIC T6...T1 Gb Ex ia IIB T6...T1 Gb
II3(1)G	Ex ec [ia Ga] IIC T5...T4 Gc	II2G	Ex ia IIC T6...T1 Gb Ex ia IIB T6...T1 Gb

Ex tb

Transmitter		Sensor	
Category	Type of protection	Category	Type of protection
II(1)D	[Ex ia] IIIC	II2D	Ex ia tb IIIC T** °C Db

Non-Ex / Ex ec

Transmitter		Sensor	
Category	Type of protection	Category	Type of protection
Non - Ex	Non-Ex	II3G	Ex ec IIC T5...T1 Gc
II3G	Ex ec IIC T5...T4 Gc	II3G	Ex ec IIC T5...T1 Gc

cCSA_{US}

Currently, the following versions for use in hazardous areas are available:

IS (Ex nA, Ex i)

Transmitter	Sensor
Class I Division 2 Groups A - D	Class I, II, III Division 1 Groups A-G
Class I Division 2 Groups A - D	Class I, II, III Division 1 Groups C-G

NI (Ex nA)

Transmitter	Sensor
Class I Division 2 Groups A - D	

Ex nA / Ex i

Transmitter	Sensor
Class I, Zone 2 AEx/ Ex nA [ia Ga] IIC T5...T4 Gb	Class I, Zone 1 AEx/ Ex ia IIC T6...T1 Gb Class I, Zone 1 AEx/ Ex ia IIB T6...T1 Gb
Class I, Zone 2 AEx/ Ex nA [ia Ga] IIC T5...T4 Gb	Class I, Zone 1 AEx/ Ex ia IIC T6...T1 Gb Class I, Zone 1 AEx/ Ex ia IIB T6...T1 Gb

Ex nA

Transmitter	Sensor
Class I, Zone 2 AEx/ Ex nA IIC T5...T4 Gc	Class I, Zone 2 AEx/ Ex nA IIC T5...T1 Gc

Ex tb

Transmitter	Sensor
[AEx / Ex ia] IIIC	Zone 2.1 AEx/ Ex ia tb IIIC T** °C Db

Proline 500

ATEX/IECEX

Currently, the following versions for use in hazardous areas are available:

Ex db eb

Transmitter		Sensor	
Category	Type of protection	Category	Type of protection
II2G	Ex db eb ia IIC T6...T4 Gb	II2G	Ex ia IIC T6...T1 Gb
II2G	Ex db eb ia IIB T6...T4 Gb	II2G	Ex ia IIB T6...T1 Gb
II2G	Ex db eb ia IIC T6...T4 Gb	II2G	Ex ia IIC T6...T1 Gb
II2G	Ex db eb ia IIB T6...T4 Gb	II2G	Ex ia IIB T6...T1 Gb

Ex db

Transmitter		Sensor	
Category	Type of protection	Category	Type of protection
II2G	Ex db ia IIC T6...T4 Gb	II2G	Ex ia IIC T6...T1 Gb
II2G	Ex db ia IIB T6...T4 Gb	II2G	Ex ia IIB T6...T1 Gb
II2G	Ex db ia IIC T6...T4 Gb	II2G	Ex ia IIC T6...T1 Gb
II2G	Ex db ia IIB T6...T4 Gb	II2G	Ex ia IIB T6...T1 Gb

Ex tb

Category	Type of protection	
	Transmitter	Sensor
II2D	Ex tb IIIC T85°C Db	Ex ia tb IIIC T** °C Db

Ex ec

Category	Type of protection	
	Transmitter	Sensor
II3G	Ex ec IIC T5...T4 Gc	Ex ec IIC T5...T1 Gc

cCSA US

Currently, the following versions for use in hazardous areas are available:

IS (Ex i) and XP (Ex d)

Transmitter	Sensor
Class I, III, III Division 1 Groups A-G	
Class I, III, III Division 1 Groups C-G	

NI (Ex nA)

Transmitter	Sensor
Class I Division 2 Groups ABCD	

Ex de

Transmitter	Sensor
Class I, Zone 1 AEx/ Ex de ia IIC T6...T4 Gb	Class I, Zone 1 AEx/ Ex ia IIC T6...T1 Gb
Class I, Zone 1 AEx/ Ex de ia IIB T6...T4 Gb	Class I, Zone 1 AEx/ Ex ia IIB T6...T1 Gb
Class I, Zone 1 AEx/ Ex de ia IIC T6...T4 Gb	Class I, Zone 1 AEx/ Ex ia IIC T6...T1 Gb
Class I, Zone 1 AEx/ Ex de ia IIB T6...T4 Gb	Class I, Zone 1 AEx/ Ex ia IIB T6...T1 Gb

Ex d

Transmitter	Sensor
Class I, Zone 1 AEx/ Ex d ia IIC T6...T4 Gb	Class I, Zone 1 AEx/ Ex ia IIC T6...T1 Gb
Class I, Zone 1 AEx/ Ex d ia IIB T6...T4 Gb	Class I, Zone 1 AEx/ Ex ia IIB T6...T1 Gb
Class I, Zone 1 AEx/ Ex d ia IIC T6...T4 Gb	Class I, Zone 1 AEx/ Ex ia IIC T6...T1 Gb
Class I, Zone 1 AEx/ Ex d ia IIB T6...T4 Gb	Class I, Zone 1 AEx/ Ex ia IIB T6...T1 Gb

Ex nA

Transmitter	Sensor
Class I, Zone 2 AEx/ Ex nA IIC T5...T4 Gc	Class I, Zone 2 AEx/ Ex nA IIC T5...T1 Gc

Ex tb

Transmitter	Sensor
Zone 2 1 AEx/ Ex tb IIIC T85°C Db	Zone 2 1 AEx/ Ex ia tb IIIC T** °C Db

- Pharmaceutical compatibility**
- FDA
 - USP Class VI
 - TSE/BSE Certificate of Suitability

Functional safety The measuring device can be used for flow monitoring systems (min., max., range) up to SIL 2 (single-channel architecture; order code for "Additional approval", option LA) and SIL 3 (multichannel architecture with homogeneous redundancy) and is independently evaluated and certified by the TÜV in accordance with IEC 61508.

The following types of monitoring in safety equipment are possible:

- Mass flow
- Volume flow
- Density



Functional Safety Manual with information on the SIL device → 102

HART certification**HART interface**

The measuring device is certified and registered by the FieldComm Group. The measuring system meets all the requirements of the following specifications:

- Certified according to HART 7
- The device can also be operated with certified devices of other manufacturers (interoperability)

FOUNDATION Fieldbus certification**FOUNDATION Fieldbus interface**

The measuring device is certified and registered by the FieldComm Group. The measuring system meets all the requirements of the following specifications:

- Certified in accordance with FOUNDATION Fieldbus H1
- Interoperability Test Kit (ITK), revision version 6.2.0 (certificate available on request)
- Physical Layer Conformance Test
- The device can also be operated with certified devices of other manufacturers (interoperability)

Certification PROFIBUS**PROFIBUS interface**

The measuring device is certified and registered by the PNO (PROFIBUS User Organization Organization). The measuring system meets all the requirements of the following specifications:

- Certified in accordance with PROFIBUS PA Profile 3.02
- The device can also be operated with certified devices of other manufacturers (interoperability)

EtherNet/IP certification

The measuring device is certified and registered by the ODVA (Open Device Vendor Association). The measuring system meets all the requirements of the following specifications:

- Certified in accordance with the ODVA Conformance Test
- EtherNet/IP Performance Test
- EtherNet/IP PlugFest compliance
- The device can also be operated with certified devices of other manufacturers (interoperability)

Certification PROFINET**PROFINET interface**

The measuring device is certified and registered by the PNO (PROFIBUS User Organization Organization). The measuring system meets all the requirements of the following specifications:

- Certified according to:
 - Test specification for PROFINET devices
 - PROFINET Security Level 2 – Netload Class
- The device can also be operated with certified devices of other manufacturers (interoperability)

Pressure Equipment Directive

The devices can be ordered with or without a PED approval. If a device with a PED approval is required, this must be explicitly stated in the order. For devices with nominal diameters less than or equal to DN 25 (1"), this is neither possible nor necessary.

- With the identification PED/G1/x (x = category) on the sensor nameplate, Endress+Hauser confirms conformity with the "Essential Safety Requirements" specified in Appendix I of the Pressure Equipment Directive 2014/68/EU.
- Devices bearing this marking (PED) are suitable for the following types of medium:
 - Media in Group 1 and 2 with a vapor pressure greater than, or smaller and equal to 0.5 bar (7.3 psi)
 - Unstable gases
- Devices not bearing this marking (PED) are designed and manufactured according to good engineering practice. They meet the requirements of Article 4 paragraph 3 of the Pressure Equipment Directive 2014/68/EU. The range of application is indicated in tables 6 to 9 in Annex II of the Pressure Equipment Directive 2014/68/EU.

Radio approval

The measuring device has radio approval.



For detailed information on the radio approval, see the Special Documentation → 102

Additional certification**CRN approval**

Some device versions have CRN approval. A CRN-approved process connection with a CSA approval must be ordered for a CRN-approved device.

Tests and certificates

- Pressure test, internal procedure, inspection certificate
- EN10204-3.1 material certificate, wetted parts and sensor housing
- PMI test (XRF), internal procedure, wetted parts, test report
- EN10204-2.1 confirmation of compliance with the order and EN10204-2.2 test report

Other standards and guidelines

- EN 60529
Degrees of protection provided by enclosures (IP code)
- IEC/EN 60068-2-6
Environmental influences: Test procedure - Test Fc: vibrate (sinusoidal).
- IEC/EN 60068-2-31
Environmental influences: Test procedure - Test Ec: shocks due to rough handling, primarily for devices.
- EN 61010-1
Safety requirements for electrical equipment for measurement, control and laboratory use - general requirements
- IEC/EN 61326
Emission in accordance with Class A requirements. Electromagnetic compatibility (EMC requirements).
- NAMUR NE 21
Electromagnetic compatibility (EMC) of industrial process and laboratory control equipment
- NAMUR NE 32
Data retention in the event of a power failure in field and control instruments with microprocessors
- NAMUR NE 43
Standardization of the signal level for the breakdown information of digital transmitters with analog output signal.
- NAMUR NE 53
Software of field devices and signal-processing devices with digital electronics
- NAMUR NE 80
The application of the pressure equipment directive to process control devices
- NAMUR NE 105
Specifications for integrating fieldbus devices in engineering tools for field devices
- NAMUR NE 107
Self-monitoring and diagnosis of field devices
- NAMUR NE 131
Requirements for field devices for standard applications
- NAMUR NE 132
Coriolis mass meter

Ordering information

Detailed ordering information is available from the following sources:

- In the Product Configurator on the Endress+Hauser website: www.endress.com -> Click "Corporate" -> Select your country -> Click "Products" -> Select the product using the filters and search field -> Open product page -> The "Configure" button to the right of the product image opens the Product Configurator.
- From your Endress+Hauser Sales Center: www.addresses.endress.com



Product Configurator - the tool for individual product configuration

- Up-to-the-minute configuration data
 - Depending on the device: Direct input of measuring point-specific information such as measuring range or operating language
 - Automatic verification of exclusion criteria
 - Automatic creation of the order code and its breakdown in PDF or Excel output format
 - Ability to order directly in the Endress+Hauser Online Shop

Application packages

Many different application packages are available to enhance the functionality of the device. Such packages might be needed to address safety aspects or specific application requirements.

The application packages can be ordered with the device or subsequently from Endress+Hauser. Detailed information on the order code in question is available from your local Endress+Hauser sales center or on the product page of the Endress+Hauser website: www.endress.com.





Detailed information on the application packages:
Special Documentation for the device → 102

Diagnostics functions	
Package	Description
Extended HistoROM	<p>Comprises extended functions concerning the event log and the activation of the measured value memory.</p> <p>Event log: Memory volume is extended from 20 message entries (standard version) to up to 100 entries.</p> <p>Data logging (line recorder):</p> <ul style="list-style-type: none"> ▪ Memory capacity for up to 1000 measured values is activated. ▪ 250 measured values can be output via each of the 4 memory channels. The recording interval can be defined and configured by the user. ▪ Measured value logs can be accessed via the local display or operating tool e.g. FieldCare, DeviceCare or Web server.

Heartbeat Technology	
Package	Description
Heartbeat Verification +Monitoring	<p>Heartbeat Verification Meets the requirement for traceable verification to DIN ISO 9001:2008 Chapter 7.6 a) "Control of monitoring and measuring equipment".</p> <ul style="list-style-type: none"> ▪ Functional testing in the installed state without interrupting the process. ▪ Traceable verification results on request, including a report. ▪ Simple testing process via local operation or other operating interfaces. ▪ Clear measuring point assessment (pass/fail) with high test coverage within the framework of manufacturer specifications. ▪ Extension of calibration intervals according to operator's risk assessment. <p>Heartbeat Monitoring Continuously supplies data, which are characteristic of the measuring principle, to an external condition monitoring system for the purpose of preventive maintenance or process analysis. These data enable the operator to:</p> <ul style="list-style-type: none"> ▪ Draw conclusions - using these data and other information - about the impact process influences (such as corrosion, abrasion, buildup etc.) have on the measuring performance over time. ▪ Schedule servicing in time. ▪ Monitor the process or product quality, e.g. gas pockets.

Concentration	
Package	Description
Concentration	<p>Calculation and outputting of fluid concentrations</p> <p>The measured density is converted to the concentration of a substance of a binary mixture using the "Concentration" application package:</p> <ul style="list-style-type: none"> ▪ Choice of predefined fluids (e.g. various sugar solutions, acids, alkalis, salts, ethanol etc.) ▪ Common or user-defined units ("Brix", "Plato", "% mass", "% volume, mol/l etc.) for standard applications. ▪ Concentration calculation from user-defined tables.

Special density	
Package	Description
Special density	<p>Many applications use density as a key measured value for monitoring quality or controlling processes. The device measures the density of the fluid as standard and makes this value available to the control system.</p> <p>The "Special Density" application package offers high-precision density measurement over a wide density and temperature range particularly for applications subject to varying process conditions.</p>













OPC-UA server	
Package	Description
OPC-UA-Server	<p>The application package provides the user with an integrated OPC-UA server for comprehensive instrument services for IoT and SCADA applications.</p> <p> Special Documentation for the "OPC-UA-Server" application package →  102.</p>



Accessories

Various accessories, which can be ordered with the device or subsequently from Endress+Hauser, are available for the device. Detailed information on the order code in question is available from your local Endress+Hauser sales center or on the product page of the Endress+Hauser website: www.endress.com.



Device-specific accessories

For the transmitter





Accessories	Description
Transmitter <ul style="list-style-type: none"> ▪ Proline 500 – digital ▪ Proline 500 	Transmitter for replacement or storage. Use the order code to define the following specifications: <ul style="list-style-type: none"> ▪ Approvals ▪ Output ▪ Input ▪ Display/operation ▪ Housing ▪ Software <p> ▪ Proline 500 – digital transmitter: Order code: 8X5BXX-XXXXXXXXXA</p> <p>▪ Proline 500 transmitter: Order code: 8X5BXX-XXXXXXXXXB</p> <p> Proline 500 transmitter for replacement: It is essential to specify the serial number of the current transmitter when ordering. Based on the serial number, the device-specific data (e.g., calibration factors) of the replacement device can be used for the new transmitter.</p> <p> ▪ Proline 500 – digital transmitter: Installation Instructions EA01151 ▪ Proline 500 transmitter: Installation Instructions EA01152</p>
External WLAN antenna	External WLAN antenna with 1.5 m (59.1 in) connecting cable and two angle brackets. Order code for "Enclosed accessories", option P8 "Wireless antenna wide area". <p> ▪ The external WLAN antenna is not suitable for use in hygienic applications. ▪ Further information on the WLAN interface →  87.</p> <p> Order number: 71351317</p> <p> Installation Instructions EA01238D</p>
Pipe mounting set	Pipe mounting set for transmitter. <p> ▪ Proline 500 – digital transmitter Order number: 71346427</p> <p>▪ Proline 500 transmitter Order number: 71346428</p>
Protective cover Transmitter <ul style="list-style-type: none"> ▪ Proline 500 – digital ▪ Proline 500 	Is used to protect the measuring device from the effects of the weather: e.g. rainwater, excess heating from direct sunlight. <p> ▪ Proline 500 – digital transmitter Order number: 71343504</p> <p>▪ Proline 500 transmitter Order number: 71343505</p> <p> Installation Instructions EA01160</p>
Display guard Proline 500 – digital	Is used to protect the measuring device from the effects of the weather: e.g. rainwater, excess heating from direct sunlight. <p> Order number: 71228792</p> <p> For details, see Installation Instructions EA01093</p>



<p>Connecting cable Proline 500 – digital Sensor – Transmitter</p>	<p>The connecting cable can be ordered directly with the measuring device (order code for "Cable, sensor connection) or as an accessory (order number DK8012).</p> <p>The following cable lengths are available: order code for "Cable, sensor connection"</p> <ul style="list-style-type: none"> ▪ Option B: 20 m (65 ft) ▪ Option E: User configurable up to max. 50 m ▪ Option F: User configurable up to max. 165 ft <p> Maximum possible cable length for a Proline 500 – digital connecting cable: 300 m (1000 ft)</p>
<p>Connecting cable Proline 500 Sensor – Transmitter</p>	<p>The connecting cable can be ordered directly with the measuring device (order code for "Cable, sensor connection) or as an accessory (order number DK8012).</p> <p>The following cable lengths are available: order code for "Cable, sensor connection"</p> <ul style="list-style-type: none"> ▪ Option 1: 5 m (16 ft) ▪ Option 2: 10 m (32 ft) ▪ Option 3: 20 m (65 ft) <p> Possible cable length for a Proline 500 connecting cable: max. 20 m (65 ft)</p>

For the sensor



Accessories	Description
<p>Heating jacket</p>	<p>Is used to stabilize the temperature of the fluids in the sensor. Water, water vapor and other non-corrosive liquids are permitted for use as fluids.</p> <p> If using oil as a heating medium, please consult with Endress+Hauser.</p> <p> Special Documentation SD02157D</p>

Communication-specific accessories



Accessories	Description
<p>Commubox FXA195 HART</p>	<p>For intrinsically safe HART communication with FieldCare via the USB interface.</p> <p> Technical Information TI00404F</p>
<p>HART Loop Converter HMX50</p>	<p>Is used to evaluate and convert dynamic HART process variables to analog current signals or limit values.</p> <p> <ul style="list-style-type: none"> ▪ Technical Information TI00429F ▪ Operating Instructions BA00371F </p>
<p>Fieldgate FXA320</p>	<p>Gateway for the remote monitoring of connected 4-20 mA measuring devices via a Web browser.</p> <p> <ul style="list-style-type: none"> Technical Information TI00025S Operating Instructions BA00053S </p>
<p>Fieldgate FXA520</p>	<p>Gateway for the remote diagnostics and remote configuration of connected HART measuring devices via a Web browser.</p> <p> <ul style="list-style-type: none"> Technical Information TI00025S Operating Instructions BA00051S </p>
<p>Field Xpert SFX350</p>	<p>Field Xpert SFX350 is a mobile computer for commissioning and maintenance. It enables efficient device configuration and diagnostics for HART and FOUNDATION Fieldbus devices and can be used in non-hazardous areas.</p> <p> Operating Instructions BA01202S</p>



Field Xpert SFX370	<p>Field Xpert SFX370 is a mobile computer for commissioning and maintenance. It enables efficient device configuration and diagnostics for HART and FOUNDATION Fieldbus devices and can be used in the non-hazardous area and in the hazardous area.</p> <p> Operating Instructions BA01202S</p>
Field Xpert SMT70	<p>The Field Xpert SMT70 tablet PC for device configuration enables mobile plant asset management in hazardous and non-hazardous areas. It is suitable for commissioning and maintenance staff to manage field instruments with a digital communication interface and to record progress.</p> <p>This tablet PC is designed as an all-in-one solution with a preinstalled driver library and is an easy-to-use, touch-sensitive tool which can be used to manage field instruments throughout their entire life cycle.</p> <p> <ul style="list-style-type: none"> ▪ Technical Information TI01342S ▪ Operating Instructions BA01709S ▪ Product page: www.endress.com/smt70 </p>

Service-specific accessories

Accessories	Description
Applicator	<p>Software for selecting and sizing Endress+Hauser measuring devices:</p> <ul style="list-style-type: none"> ▪ Choice of measuring devices for industrial requirements ▪ Calculation of all the necessary data for identifying the optimum flowmeter: e.g. nominal diameter, pressure loss, flow velocity and accuracy. ▪ Graphic illustration of the calculation results ▪ Determination of the partial order code, administration, documentation and access to all project-related data and parameters over the entire life cycle of a project. <p>Applicator is available:</p> <ul style="list-style-type: none"> ▪ Via the Internet: https://portal.endress.com/webapp/applicator ▪ As a downloadable DVD for local PC installation.
W@M	<p>W@M Life Cycle Management</p> <p>Improved productivity with information at your fingertips. Data relevant to a plant and its components is generated from the first stages of planning and during the asset's complete life cycle.</p> <p>W@M Life Cycle Management is an open and flexible information platform with online and on-site tools. Instant access for your staff to current, in-depth data shortens your plant's engineering time, speeds up procurement processes and increases plant uptime.</p> <p>Combined with the right services, W@M Life Cycle Management boosts productivity in every phase. For more information, visit www.endress.com/lifecyclemanagement</p>
FieldCare	<p>FDT-based plant asset management tool from Endress+Hauser.</p> <p>It can configure all smart field units in your system and helps you manage them. By using the status information, it is also a simple but effective way of checking their status and condition.</p> <p> Operating Instructions BA00027S and BA00059S</p>
DeviceCare	<p>Tool to connect and configure Endress+Hauser field devices.</p> <p> Innovation brochure IN01047S</p>

System components

Accessories	Description
Memograph M graphic data manager	<p>The Memograph M graphic data manager provides information on all the relevant measured variables. Measured values are recorded correctly, limit values are monitored and measuring points analyzed. The data are stored in the 256 MB internal memory and also on a SD card or USB stick.</p> <p> <ul style="list-style-type: none"> ▪ Technical Information TI00133R ▪ Operating Instructions BA00247R </p>
Cerabar M	<p>The pressure transmitter for measuring the absolute and gauge pressure of gases, steam and liquids. It can be used to read in the operating pressure value.</p> <p> <ul style="list-style-type: none"> ▪ Technical Information TI00426P and TI00436P ▪ Operating Instructions BA00200P and BA00382P </p>

Accessories	Description
Cerabar S	The pressure transmitter for measuring the absolute and gauge pressure of gases, steam and liquids. It can be used to read in the operating pressure value.  <ul style="list-style-type: none"> ▪ Technical Information TI00383P ▪ Operating Instructions BA00271P
iTEMP	The temperature transmitters can be used in all applications and are suitable for the measurement of gases, steam and liquids. They can be used to read in the medium temperature.  "Fields of Activity" document FA00006T

Supplementary documentation

-  For an overview of the scope of the associated Technical Documentation, refer to the following:
- *W@M Device Viewer* (www.endress.com/deviceviewer): Enter the serial number from nameplate
 - *Endress+Hauser Operations App*: Enter the serial number from the nameplate or scan the 2D matrix code (QR code) on the nameplate

Standard documentation Brief Operating Instructions

Brief Operating Instructions for the sensor

Measuring device	Documentation code
Proline Promass H	KA01283D

Brief Operating Instructions for transmitter

Measuring device	Documentation code						
	HART	FOUNDATION Fieldbus	PROFIBUS PA	PROFIBUS DP	Modbus RS485	EtherNet/IP	PROFINET
Proline 500 – digital	KA01315D	KA01233D	KA01392D	KA01390D	KA01319D	KA01346D	KA01351D
Proline 500	KA01314D	KA01291D	KA01391D	KA01389D	KA01318D	KA01347D	KA01350D

Operating Instructions

Measuring device	Documentation code						
	HART	FOUNDATION Fieldbus	PROFIBUS PA	PROFIBUS DP	Modbus RS485	EtherNet/IP	PROFINET
Promass H 500	BA01530D	BA01563D	BA01552D	BA01874D	BA01541D	BA01751D	BA01762D

Description of Device Parameters

Measuring device	Documentation code						
	HART	FOUNDATION Fieldbus	PROFIBUS PA	PROFIBUS DP	Modbus RS485	EtherNet/IP	PROFINET
Promass 500	GP01060D	GP01096D	GP01061D	GP01137D	GP01062D	GP01120D	GP01121D

**Device-dependent
additional documentation****Safety instructions**

Safety instructions for electrical equipment for hazardous areas.

Contents	Documentation code
	Measuring device
ATEX/IECEX Ex i	XA01473D
ATEX/IECEX Ex ec	XA01474D
cCSAus IS	XA01475D
cCSAus Ex i	XA01509D
cCSAus Ex nA	XA01510D
INMETRO Ex i	XA01476D
INMETRO Ex ec	XA01477D
NEPSI Ex i	XA01478D
NEPSI Ex nA	XA01479D

Special Documentation

Contents	Documentation code
Information on the Pressure Equipment Directive	SD01614D
Functional Safety Manual	SD01729D
Radio approvals for WLAN interface for A309/A310 display module	SD01793D
OPC-UA Server ¹⁾	SD02040D

1) This Special Documentation is only available for device versions with a HART output.

Contents	Documentation code						
	HART	FOUNDATION Fieldbus	PROFIBUS PA	PROFIBUS DP	Modbus RS485	PROFINET	EtherNet/IP
Web server	SD01666D	SD01669D	SD01668D	SD02232D	SD01667D	SD01971D	SD01970D
Heartbeat Technology	SD01643D	SD01608D	SD01705D	SD02203D	SD01704D	SD01989D	SD01983D
Concentration measurement	SD01645D	SD01709D	SD01711D	SD02213D	SD01710D	SD02007D	SD02006D

Installation Instructions

Contents	Comment
Installation instructions for spare part sets and accessories	Documentation code: specified for each individual accessory .

Registered trademarks**HART®**

Registered trademark of the FieldComm Group, Austin, Texas, USA

PROFIBUS®

Registered trademark of the PROFIBUS User Organization, Karlsruhe, Germany

FOUNDATION™ Fieldbus

Registration-pending trademark of the FieldComm Group, Austin, Texas, USA

Modbus®

Registered trademark of SCHNEIDER AUTOMATION, INC.

EtherNet/IP™

Trademark of ODVA, Inc.

PROFINET®

Registered trademark of the PROFIBUS User Organization, Karlsruhe, Germany

www.addresses.endress.com
