

Technical Information

Proline Promass E 200

Coriolis flowmeter



The genuine loop-powered flowmeter for minimized cost of ownership

Application

- Measuring principle operates independently of physical fluid properties such as viscosity or density
- Accurate measurement of liquids and gases for a wide range of standard applications

Device properties

- Compact dual-tube sensor
- Medium temperature up to +150 °C (+302 °F)
- Process pressure: up to 100 bar (1 450 psi)
- Loop-powered technology
- Robust dual-compartment housing
- Plant safety: worldwide approvals (SIL, Haz. area)

Your benefits

- Cost-effective – multi-purpose device; an alternative to conventional volumetric flowmeters
- Fewer process measuring points – multivariable measurement (flow, density, temperature)
- Space-saving installation – no in/outlet run needs
- Convenient device wiring – separate connection compartment
- Safe operation – no need to open the device due to display with touch control, background lighting
- Integrated verification – Heartbeat Technology

Table of contents







Document information	4	Degree of protection	33
Symbols used	4	Vibration resistance	33
Function and system design	5	Shock resistance	34
Measuring principle	5	Impact resistance	34
Measuring system	5	Interior cleaning	34
Safety	6	Electromagnetic compatibility (EMC)	34
Input	7	Process	34
Measured variable	7	Medium temperature range	34
Measuring range	7	Density	34
Operable flow range	8	Pressure-temperature ratings	34
Input signal	8	Secondary containment	37
Output	8	Rupture disk	38
Output signal	8	Flow limit	38
Signal on alarm	9	Pressure loss	38
Load	11	System pressure	38
Ex connection data	11	Thermal insulation	38
Low flow cut off	15	Heating	39
Galvanic isolation	15	Vibrations	39
Protocol-specific data	15	Mechanical construction	40
Power supply	20	Dimensions in SI units	40
Terminal assignment	20	Dimensions in US units	51
Pin assignment, device plug	21	Weight	56
Supply voltage	21	Materials	57
Power consumption	22	Process connections	58
Current consumption	22	Surface roughness	58
Power supply failure	22	Operability	58
Electrical connection	23	Operating concept	58
Potential equalization	26	Languages	59
Terminals	26	Local operation	59
Cable entries	26	Remote operation	60
Cable specification	26	Service interface	62
Overvoltage protection	26	Certificates and approvals	62
Performance characteristics	27	CE mark	62
reference operating conditions	27	C-Tick symbol	62
Maximum measured error	27	Functional safety	62
Repeatability	28	Ex approval	62
Response time	29	Sanitary compatibility	63
Influence of ambient temperature	29	Functional safety	63
Influence of medium temperature	29	HART certification	63
Influence of medium pressure	29	FOUNDATION Fieldbus certification	64
Design fundamentals	30	Certification PROFIBUS	64
Installation	30	Pressure Equipment Directive	64
Mounting location	31	Other standards and guidelines	64
Orientation	31	Ordering information	65
Inlet and outlet runs	32	Product generation index	65
Special mounting instructions	32	Application packages	65
Environment	33	Diagnostics functions	65
Ambient temperature range	33	Heartbeat Technology	66
Storage temperature	33	Accessories	66
Climate class	33	Device-specific accessories	66

Communication-specific accessories	67
Service-specific accessories	68
System components	68
Documentation	69
Standard documentation	69
Supplementary device-dependent documentation	69
Registered trademarks	70









Document information

Symbols used





Electrical symbols

Symbol	Meaning
	Direct current
	Alternating current
	Direct current and alternating current
	Ground connection A grounded terminal which, as far as the operator is concerned, is grounded via a grounding system.
	Protective ground connection A terminal which must be connected to ground prior to establishing any other connections.
	Equipotential connection A connection that has to be connected to the plant grounding system: This may be a potential equalization line or a star grounding system depending on national or company codes of practice.

Symbols for certain types of information

Symbol	Meaning
	Permitted Procedures, processes or actions that are permitted.
	Preferred Procedures, processes or actions that are preferred.
	Forbidden Procedures, processes or actions that are forbidden.
	Tip Indicates additional information.
	Reference to documentation
	Reference to page
	Reference to graphic
	Visual inspection

Symbols in graphics

Symbol	Meaning
1, 2, 3,...	Item numbers
	Series of steps
A, B, C, ...	Views
A-A, B-B, C-C, ...	Sections
	Hazardous area
	Safe area (non-hazardous area)
	Flow direction

Function and system design

Measuring principle

The measuring principle is based on the controlled generation of Coriolis forces. These forces are always present in a system when both translational and rotational movements are superimposed.

$$F_c = 2 \cdot \Delta m (v \cdot \omega)$$

F_c = Coriolis force

Δm = moving mass

ω = rotational velocity

v = radial velocity in rotating or oscillating system

The amplitude of the Coriolis force depends on the moving mass Δm , its velocity v in the system and thus on the mass flow. Instead of a constant rotational velocity ω , the sensor uses oscillation.

In the sensor, two parallel measuring tubes containing flowing fluid oscillate in antiphase, acting like a tuning fork. The Coriolis forces produced at the measuring tubes cause a phase shift in the tube oscillations (see illustration):

- At zero flow (when the fluid is at a standstill) the two tubes oscillate in phase (1).
- Mass flow causes deceleration of the oscillation at the inlet of the tubes (2) and acceleration at the outlet (3).

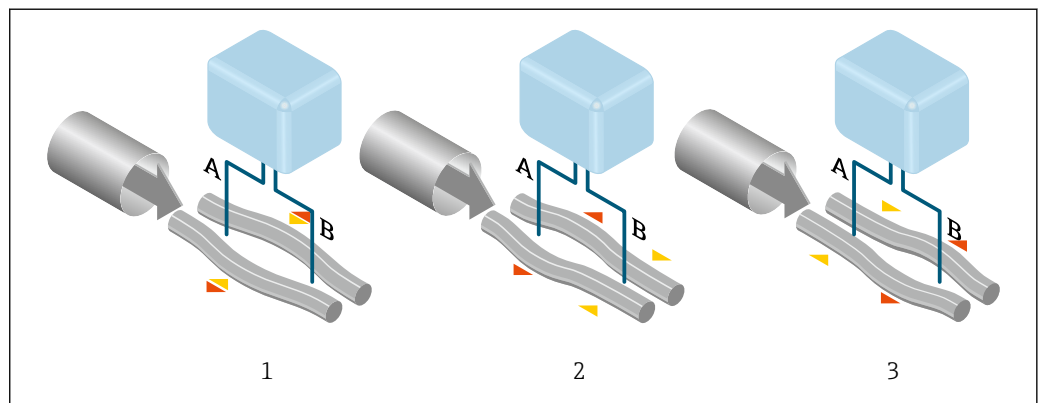

A0028850

The phase difference (A-B) increases with increasing mass flow. Electrodynamical sensors register the tube oscillations at the inlet and outlet. System balance is ensured by the antiphase oscillation of the two measuring tubes. The measuring principle operates independently of temperature, pressure, viscosity, conductivity and flow profile.

Density measurement

The measuring tube is continuously excited at its resonance frequency. A change in the mass and thus the density of the oscillating system (comprising measuring tube and fluid) results in a corresponding, automatic adjustment in the oscillation frequency. Resonance frequency is thus a function of medium density. The microprocessor utilizes this relationship to obtain a density signal.

Volume measurement

Together with the measured mass flow, this is used to calculate the volume flow.

Temperature measurement

The temperature of the measuring tube is determined in order to calculate the compensation factor due to temperature effects. This signal corresponds to the process temperature and is also available as an output signal.

Measuring system

The device consists of a transmitter and a sensor.

The device is available as a compact version:
The transmitter and sensor form a mechanical unit.

Transmitter

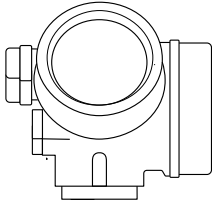
<p>Promass 200</p>  <p>A0013471</p>	<p>Device versions and materials: Compact, aluminum coated: Aluminum, AlSi10Mg, coated</p> <p>Configuration:</p> <ul style="list-style-type: none"> ■ External operation via four-line, illuminated local display with touch control and guided menus ("Make-it-run" wizards) for applications ■ Via operating tools (e.g. FieldCare)
---	---

Sensor

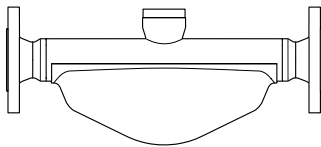
<p>Promass E</p>  <p>A0030940</p>	<ul style="list-style-type: none"> ■ Multipurpose sensor ■ Ideal substitute for volumetric flowmeters ■ Nominal diameter range: DN 8 to 50 (3/8 to 2") ■ Materials: <ul style="list-style-type: none"> - Sensor: stainless steel, 1.4301 (304) - Measuring tubes: stainless steel, 1.4539 (904L) - Process connections: stainless steel, 1.4404 (316/316L)
---	--

Safety

IT security

We only provide a warranty if the device is installed and used as described in the Operating Instructions. The device is equipped with security mechanisms to protect it against any inadvertent changes to the device settings.

IT security measures in line with operators' security standards and designed to provide additional protection for the device and device data transfer must be implemented by the operators themselves.

Device-specific IT security

The device offers a range of specific functions to support protective measures on the operator's side. These functions can be configured by the user and guarantee greater in-operation safety if used correctly. An overview of the most important functions is provided in the following section.

Protecting access via hardware write protection

Write access to the device parameters via the local display or operating tool (e.g. FieldCare, DeviceCare) can be disabled via a write protection switch (DIP switch on the motherboard). When hardware write protection is enabled, only read access to the parameters is possible.

Hardware write protection is disabled when the device is delivered.

Protecting access via a password

A password can be used to protect against write access to the device parameters.

This password locks write access to the device parameters via the local display or another operating tool (e.g. FieldCare, DeviceCare) and, in terms of functionality, is equivalent to hardware write protection. If the service interface CDI RJ-45 is used, read access is only possible if the password is entered.

User-specific access code

Write access to the device parameters via the local display or operating tool (e.g. FieldCare, DeviceCare) can be protected by the modifiable, user-specific access code.

Access via fieldbus

Cyclic fieldbus communication (read and write, e.g. measured value transmission) with a higher-order system is not affected by the restrictions mentioned above.

Input

Measured variable

Direct measured variables

- Mass flow
- Density
- Temperature

Calculated measured variables

- Volume flow
- Corrected volume flow
- Reference density

Measuring range

Measuring ranges for liquids

DN		Measuring range full scale values $\dot{m}_{\min(F)}$ to $\dot{m}_{\max(F)}$	
[mm]	[in]	[kg/h]	[lb/min]
8	$\frac{3}{8}$	0 to 2 000	0 to 73.50
15	$\frac{1}{2}$	0 to 6 500	0 to 238.9
25	1	0 to 18 000	0 to 661.5
40	$1\frac{1}{2}$	0 to 45 000	0 to 1 654
50	2	0 to 70 000	0 to 2 573



Measuring ranges for gases

The full scale values depend on the density of the gas and can be calculated with the formula below:

$$\dot{m}_{\max(G)} = \dot{m}_{\max(F)} \cdot \rho_G \cdot x$$

$\dot{m}_{\max(G)}$	Maximum full scale value for gas [kg/h]
$\dot{m}_{\max(F)}$	Maximum full scale value for liquid [kg/h]
$\dot{m}_{\max(G)} < \dot{m}_{\max(F)}$	$\dot{m}_{\max(G)}$ can never be greater than $\dot{m}_{\max(F)}$
ρ_G	Gas density in [kg/m ³] at operating conditions
x	Constant dependent on nominal diameter

DN		x
[mm]	[in]	[kg/m ³]
8	$\frac{3}{8}$	85
15	$\frac{1}{2}$	110
25	1	125
40	$1\frac{1}{2}$	125
50	2	125

 To calculate the measuring range, use the *Applicator* sizing tool →  68

Calculation example for gas

- Sensor: Promass E, DN 50
- Gas: Air with a density of 60.3 kg/m³ (at 20 °C and 50 bar)
- Measuring range (liquid): 70 000 kg/h
- $x = 125 \text{ kg/m}^3$ (for Promass E, DN 50)

Maximum possible full scale value:

$$\dot{m}_{\max(G)} = \dot{m}_{\max(F)} \cdot \rho_G \cdot x = 70\,000 \text{ kg/h} \cdot 60.3 \text{ kg/m}^3 \cdot 125 \text{ kg/m}^3 = 33\,800 \text{ kg/h}$$

Recommended measuring range

"Flow limit" section →  38

Operable flow range

Over 1000 : 1.

Flow rates above the preset full scale value do not override the electronics unit, with the result that the totalizer values are registered correctly.

Input signal**External measured values**

To increase the accuracy of certain measured variables or to calculate the corrected volume flow for gases, the automation system can continuously write the operating pressure to the measuring device. Endress+Hauser recommends the use of a pressure measuring device for absolute pressure, e.g. Cerabar M or Cerabar S.



Various pressure transmitters and temperature measuring devices can be ordered from Endress +Hauser: see "Accessories" section →  68

It is recommended to read in external measured values to calculate the following measured variables:

- Mass flow
- Corrected volume flow

HART protocol

The measured values are written from the automation system to the measuring device via the HART protocol. The pressure transmitter must support the following protocol-specific functions:

- HART protocol
- Burst mode

Digital communication

The measured values can be written from the automation system to the measuring via:



- FOUNDATION Fieldbus
- PROFIBUS PA

Output

Output signal**Current output**

Current output 1	4-20 mA HART (passive)
Current output 2	4-20 mA (passive)
Resolution	< 1 µA
Damping	Adjustable: 0.0 to 999.9 s
Assignable measured variables	<ul style="list-style-type: none"> ▪ Mass flow ▪ Volume flow ▪ Corrected volume flow ▪ Density ▪ Reference density ▪ Temperature

Pulse/frequency/switch output

Function	Can be set to pulse, frequency or switch output
Version	Passive, open collector
Maximum input values	<ul style="list-style-type: none"> ▪ DC 35 V ▪ 50 mA  For information on the Ex connection values →  11

Voltage drop	<ul style="list-style-type: none"> ▪ For ≤ 2 mA: 2 V ▪ For 10 mA: 8 V
Residual current	≤ 0.05 mA
Pulse output	
Pulse width	Adjustable: 5 to 2 000 ms
Maximum pulse rate	100 Impulse/s
Pulse value	Adjustable
Assignable measured variables	<ul style="list-style-type: none"> ▪ Mass flow ▪ Volume flow ▪ Corrected volume flow
Frequency output	
Output frequency	Adjustable: 0 to 1 000 Hz
Damping	Adjustable: 0 to 999 s
Pulse/pause ratio	1:1
Assignable measured variables	<ul style="list-style-type: none"> ▪ Mass flow ▪ Volume flow ▪ Corrected volume flow ▪ Density ▪ Reference density ▪ Temperature
Switch output	
Switching behavior	Binary, conductive or non-conductive
Switching delay	Adjustable: 0 to 100 s
Number of switching cycles	Unlimited
Assignable functions	<ul style="list-style-type: none"> ▪ Off ▪ On ▪ Diagnostic behavior ▪ Limit value <ul style="list-style-type: none"> - Mass flow - Volume flow - Corrected volume flow - Density - Reference density - Temperature - Totalizer 1-3 ▪ Flow direction monitoring ▪ Status <ul style="list-style-type: none"> - Partially filled pipe detection - Low flow cut off

FOUNDATION Fieldbus

Signal encoding	Manchester Bus Powered (MBP)
Data transfer	31.25 KBit/s, Voltage mode

PROFIBUS PA

Signal encoding	Manchester Bus Powered (MBP)
Data transfer	31.25 KBit/s, Voltage mode

Signal on alarm

Depending on the interface, failure information is displayed as follows:

Current output 4 to 20 mA*4 to 20 mA*

Failure mode	Choose from: <ul style="list-style-type: none"> ▪ 4 to 20 mA in accordance with NAMUR recommendation NE 43 ▪ 4 to 20 mA in accordance with US ▪ Min. value: 3.59 mA ▪ Max. value: 22.5 mA ▪ Freely definable value between: 3.59 to 22.5 mA ▪ Actual value ▪ Last valid value
---------------------	--

Pulse/frequency/switch output

Pulse output	
Failure mode	Choose from: <ul style="list-style-type: none"> ▪ Actual value ▪ No pulses
Frequency output	
Failure mode	Choose from: <ul style="list-style-type: none"> ▪ Actual value ▪ 0 Hz ▪ Defined value: 0 to 1250 Hz
Switch output	
Failure mode	Choose from: <ul style="list-style-type: none"> ▪ Current status ▪ Open ▪ Closed

FOUNDATION Fieldbus

Status and alarm messages	Diagnostics in accordance with FF-891
Error current FDE (Fault Disconnection Electronic)	0 mA

PROFIBUS PA

Status and alarm messages	Diagnostics in accordance with PROFIBUS PA Profile 3.02
Error current FDE (Fault Disconnection Electronic)	0 mA

Local display

Plain text display	With information on cause and remedial measures
Backlight	Additionally for device version with SD03 local display: red lighting indicates a device error.





Status signal as per NAMUR recommendation NE 107

Interface/protocol

- Via digital communication:
 - HART protocol
 - FOUNDATION Fieldbus
 - PROFIBUS PA
- Via service interface

Plain text display	With information on cause and remedial measures
---------------------------	---

 Additional information on remote operation →  60

Load

Load for current output: 0 to 500 Ω, depending on the external supply voltage of the power supply unit

Calculation of the maximum load

Depending on the supply voltage of the power supply unit (U_S), the maximum load (R_B) including line resistance must be observed to ensure adequate terminal voltage at the device. In doing so, observe the minimum terminal voltage

- For $U_S = 17.9$ to 18.9 V: $R_B \leq (U_S - 17.9$ V): 0.0036 A
- For $U_S = 18.9$ to 24 V: $R_B \leq (U_S - 13$ V): 0.022 A
- For $U_S = \geq 24$ V: $R_B \leq 500$ Ω

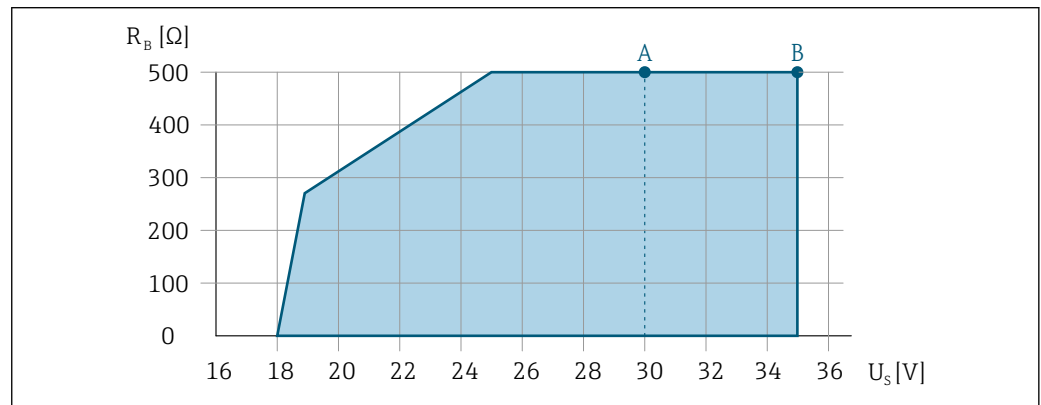

A0013563

- A Operating range for order code for "Output", option A "4-20 mA HART"/option B "4-20 mA HART, pulse/frequency/switch output" with Ex i and option C "4-20 mA HART + 4-20 mA analog"
- B Operating range for order code for "Output", option A "4-20 mA HART"/option B "4-20 mA HART, pulse/frequency/switch output" with non-Ex and Ex d

Sample calculation

Supply voltage of the power supply unit: $U_S = 19$ V
 Maximum load: $R_B \leq (19$ V - 13 V): 0.022 A = 273 Ω

Ex connection data

Safety-related values

Type of protection Ex d

Order code for "Output"	Output type	Safety-related values
Option A	4-20mA HART	$U_{nom} = DC 35$ V $U_{max} = 250$ V
Option B	4-20mA HART	$U_{nom} = DC 35$ V $U_{max} = 250$ V
	Pulse/frequency/switch output	$U_{nom} = DC 35$ V $U_{max} = 250$ V $P_{max} = 1$ W ¹⁾

Order code for "Output"	Output type	Safety-related values
Option C	4-20mA HART	$U_{nom} = DC 30 V$ $U_{max} = 250 V$
	4-20mA analog	
Option E	FOUNDATION Fieldbus	$U_{nom} = DC 32 V$ $U_{max} = 250 V$ $P_{max} = 0.88 W$
	Pulse/frequency/switch output	$U_{nom} = DC 35 V$ $U_{max} = 250 V$ $P_{max} = 1 W^{1)}$
Option G	PROFIBUS PA	$U_{nom} = DC 32 V$ $U_{max} = 250 V$ $P_{max} = 0.88 W$
	Pulse/frequency/switch output	$U_{nom} = DC 35 V$ $U_{max} = 250 V$ $P_{max} = 1 W^{1)}$

1) Internal circuit limited by $R_i = 760.5 \Omega$

Ex nA type of protection

Order code for "Output"	Output type	Safety-related values
Option A	4-20mA HART	$U_{nom} = DC 35 V$ $U_{max} = 250 V$
Option B	4-20mA HART	$U_{nom} = DC 35 V$ $U_{max} = 250 V$
	Pulse/frequency/switch output	$U_{nom} = DC 35 V$ $U_{max} = 250 V$ $P_{max} = 1 W^{1)}$
Option C	4-20mA HART	$U_{nom} = DC 30 V$ $U_{max} = 250 V$
	4-20mA analog	
Option E	FOUNDATION Fieldbus	$U_{nom} = DC 32 V$ $U_{max} = 250 V$ $P_{max} = 0.88 W$
	Pulse/frequency/switch output	$U_{nom} = DC 35 V$ $U_{max} = 250 V$ $P_{max} = 1 W^{1)}$
Option G	PROFIBUS PA	$U_{nom} = DC 32 V$ $U_{max} = 250 V$ $P_{max} = 0.88 W$
	Pulse/frequency/switch output	$U_{nom} = DC 35 V$ $U_{max} = 250 V$ $P_{max} = 1 W^{1)}$

1) Internal circuit limited by $R_i = 760.5 \Omega$

Type of protection XP

Order code for "Output"	Output type	Safety-related values
Option A	4-20mA HART	$U_{nom} = DC 35 V$ $U_{max} = 250 V$
Option B	4-20mA HART	$U_{nom} = DC 35 V$ $U_{max} = 250 V$
	Pulse/frequency/switch output	$U_{nom} = DC 35 V$ $U_{max} = 250 V$ $P_{max} = 1 W^{1)}$

Order code for "Output"	Output type	Safety-related values
Option C	4-20mA HART	$U_{nom} = DC 30 V$ $U_{max} = 250 V$
	4-20mA analog	
Option E	FOUNDATION Fieldbus	$U_{nom} = DC 32 V$ $U_{max} = 250 V$ $P_{max} = 0.88 W$
	Pulse/frequency/switch output	$U_{nom} = DC 35 V$ $U_{max} = 250 V$ $P_{max} = 1 W$ ¹⁾
Option G	PROFIBUS PA	$U_{nom} = DC 32 V$ $U_{max} = 250 V$ $P_{max} = 0.88 W$
	Pulse/frequency/switch output	$U_{nom} = DC 35 V$ $U_{max} = 250 V$ $P_{max} = 1 W$ ¹⁾

1) Internal circuit limited by $R_i = 760.5 \Omega$

Intrinsically safe values

Type of protection Ex ia

Order code for "Output"	Output type	Intrinsically safe values	
Option A	4-20mA HART	$U_i = DC 30 V$ $I_i = 300 mA$ $P_i = 1 W$ $L_i = 0 \mu H$ $C_i = 5 nF$	
Option B	4-20mA HART	$U_i = DC 30 V$ $I_i = 300 mA$ $P_i = 1 W$ $L_i = 0 \mu H$ $C_i = 5 nF$	
	Pulse/frequency/switch output	$U_i = DC 30 V$ $I_i = 300 mA$ $P_i = 1 W$ $L_i = 0 \mu H$ $C_i = 6 nF$	
Option C	4-20mA HART	$U_i = DC 30 V$ $I_i = 300 mA$ $P_i = 1 W$ $L_i = 0 \mu H$ $C_i = 30 nF$	
	4-20mA analog		
Option E	FOUNDATION Fieldbus	STANDARD $U_i = 30 V$ $I_i = 300 mA$ $P_i = 1.2 W$ $L_i = 10 \mu H$ $C_i = 5 nF$	FISCO $U_i = 17.5 V$ $I_i = 550 mA$ $P_i = 5.5 W$ $L_i = 10 \mu H$ $C_i = 5 nF$
	Pulse/frequency/switch output	$U_i = 30 V$ $I_i = 300 mA$ $P_i = 1 W$ $L_i = 0 \mu H$ $C_i = 6 nF$	

Order code for "Output"	Output type	Intrinsically safe values	
Option G	PROFIBUS PA	STANDARD U _i = 30 V I _i = 300 mA P _i = 1.2 W L _i = 10 µH C _i = 5 nF	FISCO U _i = 17.5 V I _i = 550 mA P _i = 5.5 W L _i = 10 µH C _i = 5 nF
	Pulse/frequency/switch output	U _i = 30 V I _i = 300 mA P _i = 1 W L _i = 0 µH C _i = 6 nF	

Type of protection Ex ic

Order code for "Output"	Output type	Intrinsically safe values	
Option A	4-20mA HART	U _i = DC 35 V I _i = n.a. P _i = 1 W L _i = 0 µH C _i = 5 nF	
Option B	4-20mA HART	U _i = DC 35 V I _i = n.a. P _i = 1 W L _i = 0 µH C _i = 5 nF	
	Pulse/frequency/switch output	U _i = DC 35 V I _i = n.a. P _i = 1 W L _i = 0 µH C _i = 6 nF	
Option C	4-20mA HART	U _i = DC 30 V I _i = n.a. P _i = 1 W L _i = 0 µH C _i = 30 nF	
	4-20mA analog		
Option E	FOUNDATION Fieldbus	STANDARD U _i = 32 V I _i = 300 mA P _i = n.a. L _i = 10 µH C _i = 5 nF	FISCO U _i = 17.5 V I _i = n.a. P _i = n.a. L _i = 10 µH C _i = 5 nF
	Pulse/frequency/switch output	U _i = 35 V I _i = 300 mA P _i = 1 W L _i = 0 µH C _i = 6 nF	
Option G	PROFIBUS PA	STANDARD U _i = 32 V I _i = 300 mA P _i = n.a. L _i = 10 µH C _i = 5 nF	FISCO U _i = 17.5 V I _i = n.a. P _i = n.a. L _i = 10 µH C _i = 5 nF
	Pulse/frequency/switch output	U _i = 35 V I _i = 300 mA P _i = 1 W L _i = 0 µH C _i = 6 nF	

Type of protection IS

Order code for "Output"	Output type	Intrinsically safe values	
Option A	4-20mA HART	$U_i = DC\ 30\ V$ $I_i = 300\ mA$ $P_i = 1\ W$ $L_i = 0\ \mu H$ $C_i = 5\ nF$	
Option B	4-20mA HART	$U_i = DC\ 30\ V$ $I_i = 300\ mA$ $P_i = 1\ W$ $L_i = 0\ \mu H$ $C_i = 5\ nF$	
	Pulse/frequency/switch output	$U_i = DC\ 30\ V$ $I_i = 300\ mA$ $P_i = 1\ W$ $L_i = 0\ \mu H$ $C_i = 6\ nF$	
Option C	4-20mA HART	$U_i = DC\ 30\ V$ $I_i = 300\ mA$ $P_i = 1\ W$ $L_i = 0\ \mu H$ $C_i = 30\ nF$	
	4-20mA analog		
Option E	FOUNDATION Fieldbus	STANDARD $U_i = 30\ V$ $I_i = 300\ mA$ $P_i = 1.2\ W$ $L_i = 10\ \mu H$ $C_i = 5\ nF$	FISCO $U_i = 17.5\ V$ $I_i = 550\ mA$ $P_i = 5.5\ W$ $L_i = 10\ \mu H$ $C_i = 5\ nF$
	Pulse/frequency/switch output	$U_i = 30\ V$ $I_i = 300\ mA$ $P_i = 1\ W$ $L_i = 0\ \mu H$ $C_i = 6\ nF$	
Option G	PROFIBUS PA	STANDARD $U_i = 30\ V$ $I_i = 300\ mA$ $P_i = 1.2\ W$ $L_i = 10\ \mu H$ $C_i = 5\ nF$	FISCO $U_i = 17.5\ V$ $I_i = 550\ mA$ $P_i = 5.5\ W$ $L_i = 10\ \mu H$ $C_i = 5\ nF$
	Pulse/frequency/switch output	$U_i = 30\ V$ $I_i = 300\ mA$ $P_i = 1\ W$ $L_i = 0\ \mu H$ $C_i = 6\ nF$	

Low flow cut off The switch points for low flow cut off are user-selectable.

Galvanic isolation All outputs are galvanically isolated from one another.

Protocol-specific data **HART**

Manufacturer ID	0x11
Device type ID	0x54
HART protocol revision	7
Device description files (DTM, DD)	Information and files under: www.endress.com
HART load	<ul style="list-style-type: none"> ▪ Min. 250 Ω ▪ Max. 500 Ω

Dynamic variables	<p>Read out the dynamic variables: HART command 3 The measured variables can be freely assigned to the dynamic variables.</p> <p>Measured variables for PV (primary dynamic variable)</p> <ul style="list-style-type: none"> ▪ Mass flow ▪ Volume flow ▪ Corrected volume flow ▪ Density ▪ Reference density ▪ Temperature ▪ Electronic temperature ▪ Oscillation frequency ▪ Oscillation amplitude ▪ Oscillation damping ▪ Signal asymmetry <p>Measured variables for SV, TV, QV (secondary, tertiary and quaternary dynamic variable)</p> <ul style="list-style-type: none"> ▪ Mass flow ▪ Volume flow ▪ Corrected volume flow ▪ Density ▪ Reference density ▪ Temperature ▪ Electronic temperature ▪ Oscillation frequency ▪ Oscillation amplitude ▪ Oscillation damping ▪ Signal asymmetry ▪ External pressure ▪ Totalizer 1 ▪ Totalizer 2 ▪ Totalizer 3
Device variables	<p>Read out the device variables: HART command 9 The device variables are permanently assigned.</p>

FOUNDATION Fieldbus

Manufacturer ID	0x452B48
Ident number	0x1054
Device revision	1
DD revision	Information and files under:
CFF revision	<ul style="list-style-type: none"> ▪ www.endress.com ▪ www.fieldbus.org
Device Tester Version (ITK version)	6.1.1
ITK Test Campaign Number	IT094200
Link Master capability (LAS)	Yes
Choice of "Link Master" and "Basic Device"	Yes Factory setting: Basic Device
Node address	Factory setting: 247 (0xF7)
Supported functions	<p>The following methods are supported:</p> <ul style="list-style-type: none"> ▪ Restart ▪ ENP Restart ▪ Diagnostic
Virtual Communication Relationships (VCRs)	
Number of VCRs	44
Number of link objects in VFD	50
Permanent entries	1
Client VCRs	0

Server VCRs	10
Source VCRs	43
Sink VCRs	0
Subscriber VCRs	43
Publisher VCRs	43
Device Link Capabilities	
Slot time	4
Min. delay between PDU	8
Max. response delay	Min. 5

Transducer Blocks

Block	Contents	Output values
Setup Transducer Block (TRDSUP)	All parameters for standard commissioning.	No output values
Advanced Setup Transducer Block (TRDASUP)	All parameters for more accurate measurement configuration.	No output values
Display Transducer Block (TRDDISP)	Parameters for configuring the local display.	No output values
HistoROM Transducer Block (TRDHROM)	Parameters for using the HistoROM function.	No output values
Diagnostic Transducer Block (TRDDIAG)	Diagnostics information.	Process variables (AI Channel) <ul style="list-style-type: none"> ▪ Temperature (7) ▪ Volume flow (9) ▪ Mass flow (11) ▪ Corrected volume flow (13) ▪ Density (14) ▪ Reference density (15)
Expert Configuration Transducer Block (TRDEXP)	Parameters that require the user to have in-depth knowledge of the operation of the device in order to configure the parameters appropriately.	No output values
Expert Information Transducer Block (TRDEXPIN)	Parameters that provide information about the state of the device.	No output values
Service Sensor Transducer Block (TRDSRVS)	Parameters that can only be accessed by Endress+Hauser Service.	No output values
Service Information Transducer Block (TRDSRVIF)	Parameters that provide Endress+Hauser Service with information about the state of the device.	No output values
Total Inventory Counter Transducer Block (TRDTIC)	Parameters for configuring all the totalizers and the inventory counter.	Process variables (AI Channel) <ul style="list-style-type: none"> ▪ Totalizer 1 (16) ▪ Totalizer 2 (17) ▪ Totalizer 3 (18)
Heartbeat Technology Transducer Block (TRDHBT)	Parameters for the configuration and comprehensive information about the results of the verification.	No output values
Heartbeat Results 1 Transducer Block (TRDHBTR1)	Information about the results of the verification.	No output values

Block	Contents	Output values
Heartbeat Results 2 Transducer Block (TRDHBTR2)	Information about the results of the verification.	No output values
Heartbeat Results 3 Transducer Block (TRDHBTR3)	Information about the results of the verification.	No output values
Heartbeat Results 4 Transducer Block (TRDHBTR4)	Information about the results of the verification.	No output values

Function blocks

Block	Number of blocks	Contents	Process variables (Channel)
Resource Block (RB)	1	This Block (extended functionality) contains all the data that uniquely identify the device; it is the equivalent of an electronic nameplate for the device.	–
Analog Input Block (AI)	6	This Block (extended functionality) receives the measurement data provided by the Sensor Block (can be selected via a channel number) and makes the data available for other blocks at the output. Execution time: 27 ms	<ul style="list-style-type: none"> ▪ Temperature (7) ▪ Volume flow (9) ▪ Mass flow (11) ▪ Corrected volume flow (13) ▪ Density (14) ▪ Reference density (15) ▪ Totalizer 1 (16) ▪ Totalizer 2 (17) ▪ Totalizer 3 (18)
Discrete Input Block (DI)	2	This Block (standard functionality) receives a discrete value (e.g. indicator that measuring range has been exceeded) and makes the value available for other blocks at the output. Execution time: 19 ms	<ul style="list-style-type: none"> ▪ Switch output state (101) ▪ Empty pipe detection (102) ▪ Low flow cut off (103) ▪ Status verification (105)
PID Block (PID)	1	This Block (standard functionality) acts as a proportional-integral-differential controller and can be used universally for control in the field. It enables cascading and feedforward control. Execution time: 25 ms	–
Multiple Analog Output Block (MAO)	1	This Block (standard functionality) receives several analog values and makes them available for other blocks at the output. Execution time: 22 ms	Channel_0 (121) <ul style="list-style-type: none"> ▪ Value 1: External compensation variable, pressure ▪ Value 2 to 8: Not assigned  The pressure must be transmitted to the device in the SI basic unit.

Block	Number of blocks	Contents	Process variables (Channel)
Multiple Digital Output Block (MDO)	1	This Block (standard functionality) receives several discrete values and makes them available for other blocks at the output. Execution time: 19 ms	Channel_DO (122) <ul style="list-style-type: none"> ▪ Value 1: Reset totalizer 1 ▪ Value 2: Reset totalizer 2 ▪ Value 3: Reset totalizer 3 ▪ Value 4: Flow override ▪ Value 5: Start heartbeat verification ▪ Value 6: Status switch output ▪ Value 7: Start zero point adjustment ▪ Value 8: Not assigned
Integrator Block (IT)	1	This Block (standard functionality) integrates a measured variable over time or totalizes the pulses from a Pulse Input Block. The Block can be used as a totalizer that totalizes until a reset, or as a batch totalizer whereby the integrated value is compared against a target value generated before or during the control routine and generates a binary signal when the target value is reached. Execution time: 21 ms	–

PROFIBUS PA

Manufacturer ID	0x11
Ident number	0x155F
Profile version	3.02
Device description files (GSD, DTM, DD)	Information and files under: <ul style="list-style-type: none"> ▪ www.endress.com ▪ www.profibus.org
Output values (from measuring device to automation system)	<p>Analog input 1 to 6</p> <ul style="list-style-type: none"> ▪ Mass flow ▪ Volume flow ▪ Corrected volume flow ▪ Density ▪ Reference density ▪ Temperature <p>Digital input 1 to 2</p> <ul style="list-style-type: none"> ▪ Empty pipe detection ▪ Low flow cut off ▪ Status switch output ▪ Status verification <p>Totalizer 1 to 3</p> <ul style="list-style-type: none"> ▪ Mass flow ▪ Volume flow ▪ Corrected volume flow

<p>Input values (from automation system to measuring device)</p>	<p>Analog output External pressure</p> <p>Digital output 1 to 4 (fixed assignment)</p> <ul style="list-style-type: none"> ▪ Digital output 1: switch positive zero return on/off ▪ Digital output 2: switch zero point adjustment on/off ▪ Digital output 3: switch switch output on/off ▪ Digital output 4: start verification <p>Totalizer 1 to 3</p> <ul style="list-style-type: none"> ▪ Totalize ▪ Reset and hold ▪ Preset and hold ▪ Operating mode configuration: <ul style="list-style-type: none"> - Net flow total - Forward flow total - Reverse flow total
<p>Supported functions</p>	<ul style="list-style-type: none"> ▪ Identification & Maintenance Simplest device identification on the part of the control system and nameplate ▪ PROFIBUS upload/download Reading and writing parameters is up to ten times faster with PROFIBUS upload/download ▪ Condensed status Simplest and self-explanatory diagnostic information by categorizing diagnostic messages that occur
<p>Configuration of the device address</p>	<ul style="list-style-type: none"> ▪ DIP switches on the I/O electronics module ▪ Local display ▪ via operating tools (e.g. FieldCare)

Power supply

Terminal assignment

Transmitter

Connection versions

<p>Maximum number of terminals, without integrated overvoltage protection</p>	<p>Maximum number of terminals, with integrated overvoltage protection</p>
<p>1 Output 1 (passive): supply voltage and signal transmission 2 Output 2 (passive): supply voltage and signal transmission 3 Ground terminal for cable shield</p>	

Order code for "Output"	Terminal numbers			
	Output 1		Output 2	
	1 (+)	2 (-)	3 (+)	4 (-)
Option A	4-20 mA HART (passive)		-	
Option B ¹⁾	4-20 mA HART (passive)		Pulse/frequency/switch output (passive)	
Option C ¹⁾	4-20 mA HART (passive)		4-20 mA analog (passive)	

Order code for "Output"	Terminal numbers			
	Output 1		Output 2	
	1 (+)	2 (-)	3 (+)	4 (-)
Option E ^{1) 2)}	FOUNDATION Fieldbus		Pulse/frequency/switch output (passive)	
Option G ^{1) 3)}	PROFIBUS PA		Pulse/frequency/switch output (passive)	

- 1) Output 1 must always be used; output 2 is optional.
- 2) FOUNDATION Fieldbus with integrated reverse polarity protection.
- 3) PROFIBUS PA with integrated reverse polarity protection.

Pin assignment, device plug PROFIBUS PA

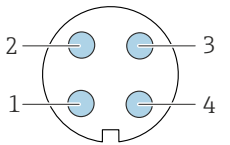
	Pin	Assignment	Coding	Plug/socket	
	1	+			PROFIBUS PA +
	2				Grounding
	3	-			PROFIBUS PA -
	4				Not assigned

FOUNDATION Fieldbus

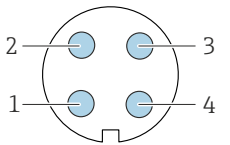
	Pin	Assignment	Coding	Plug/socket	
	1	+			Signal +
	2	-			Signal -
	3				Grounding
	4				Not assigned

Supply voltage

Transmitter

An external power supply is required for each output.

Order code for "Output"	Minimum terminal voltage	Maximum terminal voltage
Option A ^{1) 2)} : 4-20 mA HART	<ul style="list-style-type: none"> ■ For 4 mA: ≥ DC 17.9 V ■ For 20 mA: ≥ DC 13.5 V 	DC 35 V
Option B ^{1) 2)} : 4-20 mA HART, pulse/frequency/switch output	<ul style="list-style-type: none"> ■ For 4 mA: ≥ DC 17.9 V ■ For 20 mA: ≥ DC 13.5 V 	DC 35 V
Option C ^{1) 2)} : 4-20 mA HART + 4-20 mA analog	<ul style="list-style-type: none"> ■ For 4 mA: ≥ DC 17.9 V ■ For 20 mA: ≥ DC 13.5 V 	DC 30 V

Order code for "Output"	Minimum terminal voltage	Maximum terminal voltage
Option E ³⁾ : FOUNDATION Fieldbus, pulse/frequency/switch output	≥ DC 9 V	DC 32 V
Option G ³⁾ : PROFIBUS PA, pulse/frequency/switch output	≥ DC 9 V	DC 32 V

- 1) External supply voltage of the power supply unit with load.
- 2) For device versions with SD03 local display: The terminal voltage must be increased by DC 2 V if backlighting is used.
- 3) For device version with SD03 local display: The terminal voltage must be increased by DC 0.5 V if backlighting is used.



For information about the load see → 11



Various power supply units can be ordered from Endress+Hauser: → 68



For information on the Ex connection values → 11

Power consumption

Transmitter

Order code for "Output"	Maximum power consumption
Option A : 4-20 mA HART	770 mW
Option B : 4-20 mA HART, pulse/frequency/switch output	<ul style="list-style-type: none"> ▪ Operation with output 1: 770 mW ▪ Operation with output 1 and 2: 2 770 mW
Option C : 4-20 mA HART + 4-20 mA analog	<ul style="list-style-type: none"> ▪ Operation with output 1: 660 mW ▪ Operation with output 1 and 2: 1 320 mW
Option E : FOUNDATION Fieldbus, pulse/frequency/switch output	<ul style="list-style-type: none"> ▪ Operation with output 1: 576 mW ▪ Operation with output 1 and 2: 2 576 mW
Option G : PROFIBUS PA, pulse/frequency/switch output	<ul style="list-style-type: none"> ▪ Operation with output 1: 512 mW ▪ Operation with output 1 and 2: 2 512 mW



For information on the Ex connection values → 11

Current consumption

Current output

For every 4-20 mA or 4-20 mA HART current output: 3.6 to 22.5 mA



If the option **Defined value** is selected in the **Failure mode** parameter : 3.59 to 22.5 mA

PROFIBUS PA

16 mA

FOUNDATION Fieldbus

18 mA

Power supply failure

- Totalizers stop at the last value measured.
- Configuration is retained in the device memory (HistoROM).
- Error messages (incl. total operated hours) are stored.

Electrical connection

Connecting the transmitter

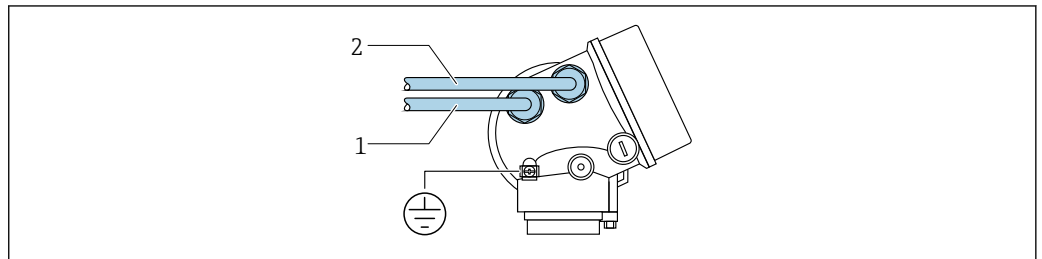

A0015510

- 1 Cable entry for output 1
- 2 Cable entry for output 2

Connection examples

Current output 4-20 mA HART

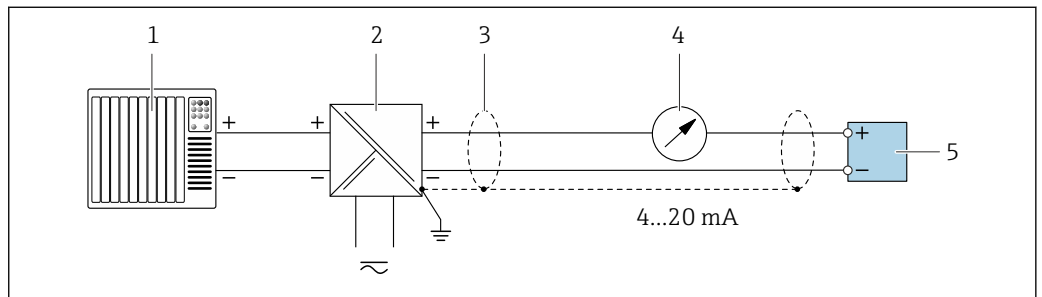

A0028762

1 Connection example for 4 to 20 mA HART current output (passive)

- 1 Automation system with current input (e.g. PLC)
- 2 Power supply
- 3 Cable shield: the cable shield must be grounded at both ends to comply with EMC requirements; observe cable specifications → 26
- 4 Analog display unit: observe maximum load → 11
- 5 Transmitter

Pulse/frequency output

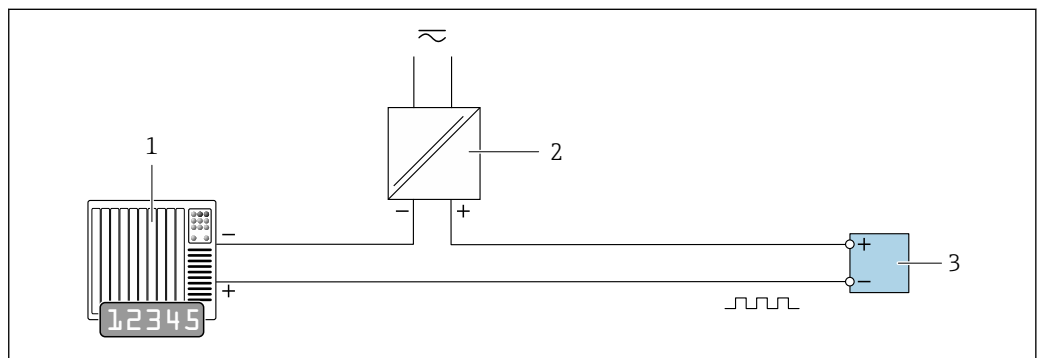

A0028761

2 Connection example for pulse/frequency output (passive)

- 1 Automation system with pulse/frequency input (e.g. PLC)
- 2 Power supply
- 3 Transmitter: Observe input values → 8

Switch output

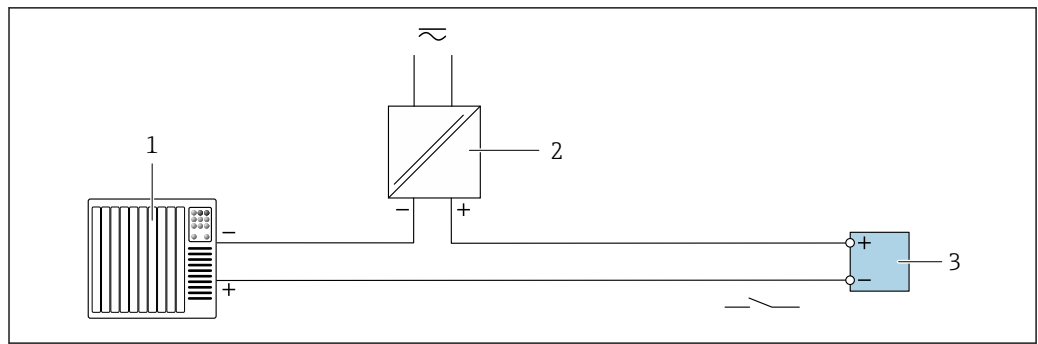

A0028760

3 Connection example for switch output (passive)

- 1 Automation system with switch input (e.g. PLC)
- 2 Power supply
- 3 Transmitter: Observe input values → 8

PROFIBUS-PA

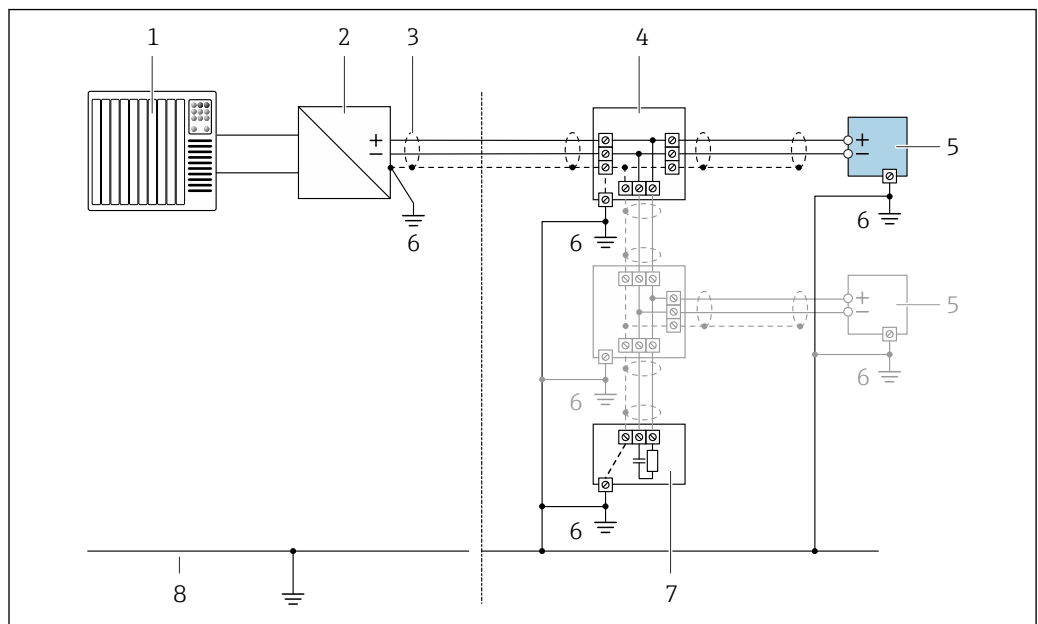

A0028768

4 Connection example for PROFIBUS-PA

- 1 Control system (e.g. PLC)
- 2 PROFIBUS PA segment coupler
- 3 Cable shield: the cable shield must be grounded at both ends to comply with EMC requirements; observe cable specifications
- 4 T-box
- 5 Measuring device
- 6 Local grounding
- 7 Bus terminator
- 8 Potential matching line

FOUNDATION Fieldbus

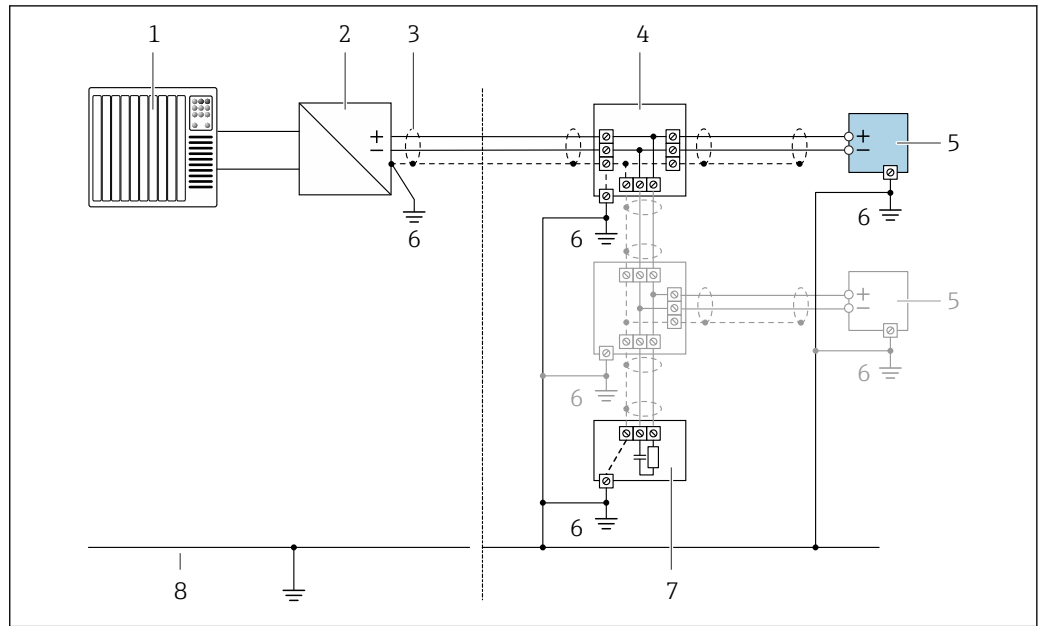

A0028768

5 Connection example for FOUNDATION Fieldbus

- 1 Control system (e.g. PLC)
- 2 Power Conditioner (FOUNDATION Fieldbus)
- 3 Cable shield: the cable shield must be grounded at both ends to comply with EMC requirements; observe cable specifications
- 4 T-box
- 5 Measuring device
- 6 Local grounding
- 7 Bus terminator
- 8 Potential matching line

HART input

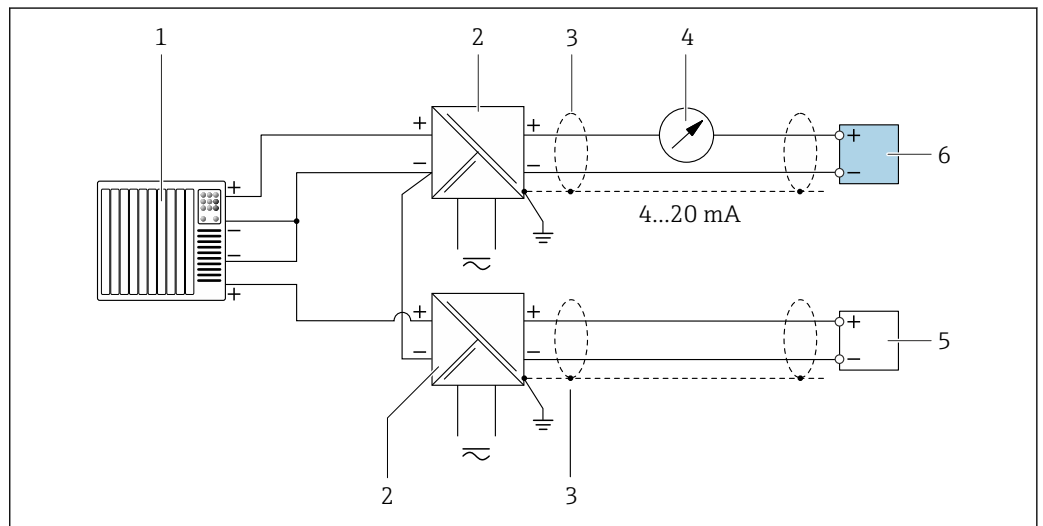

A0028763

6 Connection example for HART input with a common negative (passive)

- 1 Automation system with HART output (e.g. PLC)
- 2 Active barrier for power supply (e.g. RN221N)
- 3 Cable shield: the cable shield must be grounded at both ends to comply with EMC requirements; observe cable specifications
- 4 Analog display unit: observe maximum load → 11
- 5 Pressure measuring device (e.g. Cerabar M, Cerabar S): see requirements
- 6 Transmitter

Potential equalization**Requirements**

No special measures for potential equalization are required.



For devices intended for use in hazardous locations, please observe the guidelines in the Ex documentation (XA).

Terminals

- For device version without integrated overvoltage protection: plug-in spring terminals for wire cross-sections 0.5 to 2.5 mm² (20 to 14 AWG)
- For device version with integrated overvoltage protection: screw terminals for wire cross-sections 0.2 to 2.5 mm² (24 to 14 AWG)

Cable entries

- Cable gland (not for Ex d): M20 × 1.5 with cable ϕ 6 to 12 mm (0.24 to 0.47 in)
- Thread for cable entry:
 - For non-Ex and Ex: NPT 1/2"
 - For non-Ex and Ex (not for CSA Ex d/XP): G 1/2"
 - For Ex d: M20 × 1.5

Cable specification**Permitted temperature range**

Minimum requirement: cable temperature range \geq ambient temperature +20 K

Signal cable

Current output 4 to 20 mA HART

A shielded cable is recommended. Observe grounding concept of the plant.

Current output 4 to 20 mA

Standard installation cable is sufficient.

Pulse/frequency/switch output

Standard installation cable is sufficient.

FOUNDATION Fieldbus

Twisted, shielded two-wire cable.



For further information on planning and installing FOUNDATION Fieldbus networks see:

- Operating Instructions for "FOUNDATION Fieldbus Overview" (BA00013S)
- FOUNDATION Fieldbus Guideline
- IEC 61158-2 (MBP)

PROFIBUS PA

Twisted, shielded two-wire cable. Cable type A is recommended.



For further information on planning and installing PROFIBUS PA networks see:

- Operating Instructions "PROFIBUS DP/PA: Guidelines for planning and commissioning" (BA00034S)
- PNO Directive 2.092 "PROFIBUS PA User and Installation Guideline"
- IEC 61158-2 (MBP)

Overvoltage protection

The device can be ordered with integrated overvoltage protection for diverse approvals:
Order code for "Accessory mounted", option NA "Overvoltage protection"

Input voltage range	Values correspond to supply voltage specifications ¹⁾
Resistance per channel	2 · 0.5 Ω max
DC sparkover voltage	400 to 700 V
Trip surge voltage	< 800 V
Capacitance at 1 MHz	< 1.5 pF

Nominal discharge current (8/20 μ s)	10 kA
Temperature range	-40 to +85 °C (-40 to +185 °F)



1) The voltage is reduced by the amount of the internal resistance $I_{min} \cdot R_i$

 Depending on the temperature class, restrictions apply to the ambient temperature for device versions with overvoltage protection

Performance characteristics

reference operating conditions



- Error limits based on ISO 11631
- Water with +15 to +45 °C (+59 to +113 °F) at 2 to 6 bar (29 to 87 psi)
- Specifications as per calibration protocol
- Accuracy based on accredited calibration rigs that are traced to ISO 17025.

 To obtain measured errors, use the *Applicator* sizing tool →  68

Maximum measured error

o.r. = of reading; 1 g/cm³ = 1 kg/l; T = medium temperature

Base accuracy

 Design fundamentals →  30

Mass flow and volume flow (liquids)

±0.25 % o.r.

Mass flow (gases)

±0.75 % o.r.

Density (liquids)

Under reference operating conditions [g/cm ³]	Standard density calibration ¹⁾ [g/cm ³]
±0.0005	±0.02

1) Valid over the entire temperature and density range

Temperature

$\pm 0.5 \text{ °C} \pm 0.005 \cdot T \text{ °C}$ ($\pm 0.9 \text{ °F} \pm 0.003 \cdot (T - 32) \text{ °F}$)

Zero point stability

DN		Zero point stability	
[mm]	[in]	[kg/h]	[lb/min]
8	$\frac{3}{8}$	0.24	0.0088
15	$\frac{1}{2}$	0.78	0.0287
25	1	2.16	0.0794
40	$1\frac{1}{2}$	5.40	0.1985
50	2	8.40	0.3087

Flow values

Flow values as turndown parameter depending on nominal diameter.

SI units

DN	1:1	1:10	1:20	1:50	1:100	1:500
[mm]	[kg/h]	[kg/h]	[kg/h]	[kg/h]	[kg/h]	[kg/h]
8	2 000	200	100	40	20	4
15	6 500	650	325	130	65	13
25	18 000	1 800	900	360	180	36
40	45 000	4 500	2 250	900	450	90
50	70 000	7 000	3 500	1 400	700	140

US units

DN	1:1	1:10	1:20	1:50	1:100	1:500
[inch]	[lb/min]	[lb/min]	[lb/min]	[lb/min]	[lb/min]	[lb/min]
$\frac{3}{8}$	73.50	7.350	3.675	1.470	0.735	0.147
$\frac{1}{2}$	238.9	23.89	11.95	4.778	2.389	0.478
1	661.5	66.15	33.08	13.23	6.615	1.323
1½	1 654	165.4	82.70	33.08	16.54	3.308
2	2 573	257.3	128.7	51.46	25.73	5.146

Accuracy of outputs

The outputs have the following base accuracy specifications.

Current output

Accuracy	±10 µA
-----------------	--------

Pulse/frequency output

o.r. = of reading

Accuracy	Max. ±100 ppm o.r.
-----------------	--------------------

Repeatability

o.r. = of reading; 1 g/cm³ = 1 kg/l; T = medium temperature

Base repeatability**Mass flow and volume flow (liquids)**

±0.125 % o.r.

Mass flow (gases)

±0.35 % o.r.

 Design fundamentals →  30

Density (liquids)

±0.00025 g/cm³

Temperature

±0.25 °C ± 0.0025 · T °C (±0.45 °F ± 0.0015 · (T-32) °F)

Response time

- The response time depends on the configuration (damping).
- Response time in the event of erratic changes in the measured variable: After 500 ms → 95 % of full scale value

Influence of ambient temperature

Current output

o.r. = of reading

Additional error, in relation to the span of 16 mA:

Temperature coefficient at zero point (4 mA)	0.02 %/10 K
Temperature coefficient with span (20 mA)	0.05 %/10 K

Pulse/frequency output

o.r. = of reading

Temperature coefficient	Max. ±100 ppm o.r.
-------------------------	--------------------

Influence of medium temperature

Mass flow and volume flow

o.f.s. = of full scale value

When there is a difference between the temperature at zero point adjustment and the process temperature, the typical measured error of the sensor is ±0.0002 % o.f.s./°C (±0.0001 % o. f.s./°F).

Density

When there is a difference between the density calibration temperature and the process temperature, the typical measured error of the sensor is ±0.0001 g/cm³ /°C (±0.00005 g/cm³ /°F). Field density calibration is possible.

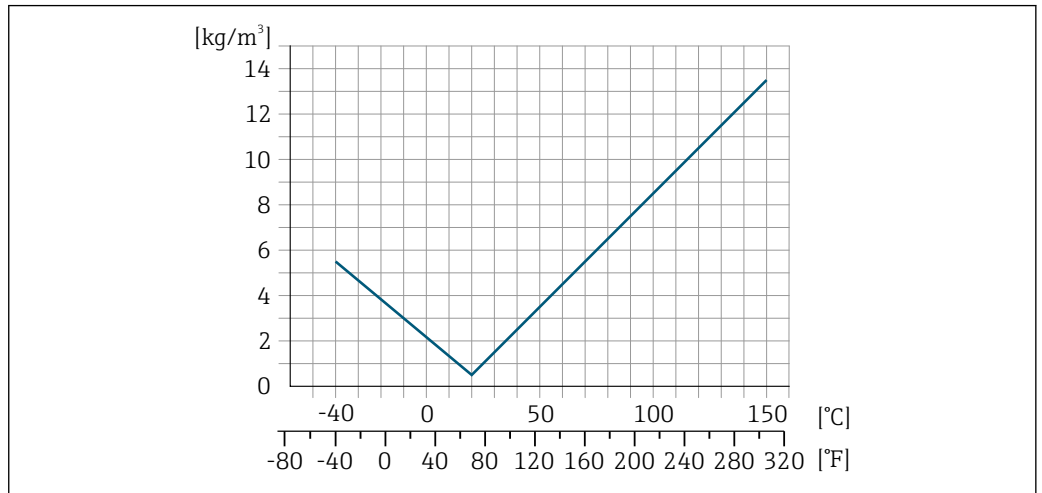

7 Field density calibration, for example at +20 °C (+68 °F)

Temperature

$$\pm 0.005 \cdot T \text{ } ^\circ\text{C} (\pm 0.005 \cdot (T - 32) \text{ } ^\circ\text{F})$$

Influence of medium pressure

The table below shows the effect on accuracy of mass flow due to a difference between calibration pressure and process pressure.

o.r. = of reading

DN		[% o.r./bar]	[% o.r./psi]
[mm]	[in]		
8	3/8	no influence	
15	1/2	no influence	
25	1	no influence	
40	1 1/2	no influence	
50	2	-0.009	-0.0006

Design fundamentals

o.r. = of reading, o.f.s. = of full scale value

BaseAccu = base accuracy in % o.r., BaseRepeat = base repeatability in % o.r.

MeasValue = measured value; ZeroPoint = zero point stability

Calculation of the maximum measured error as a function of the flow rate

Flow rate	Maximum measured error in % o.r.
$\geq \frac{\text{ZeroPoint}}{\text{BaseAccu}} \cdot 100$ <small>A0021332</small>	$\pm \text{BaseAccu}$ <small>A0021339</small>
$< \frac{\text{ZeroPoint}}{\text{BaseAccu}} \cdot 100$ <small>A0021333</small>	$\pm \frac{\text{ZeroPoint}}{\text{MeasValue}} \cdot 100$ <small>A0021334</small>

Calculation of the maximum repeatability as a function of the flow rate

Flow rate	Maximum repeatability in % o.r.
$\geq \frac{4/3 \cdot \text{ZeroPoint}}{\text{BaseAccu}} \cdot 100$ <small>A0021341</small>	$\pm 1/2 \cdot \text{BaseAccu}$ <small>A0021343</small>
$< \frac{4/3 \cdot \text{ZeroPoint}}{\text{BaseAccu}} \cdot 100$ <small>A0021342</small>	$\pm 2/3 \cdot \frac{\text{ZeroPoint}}{\text{MeasValue}} \cdot 100$ <small>A0021344</small>

Example for max. measured error

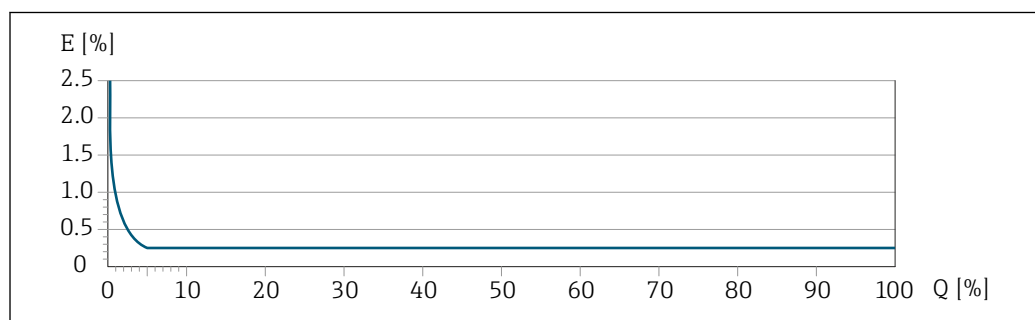

8 Maximum measured error in % o.r. (example: DN 25)

Installation

No special measures such as supports etc. are necessary. External forces are absorbed by the construction of the device.

Mounting location

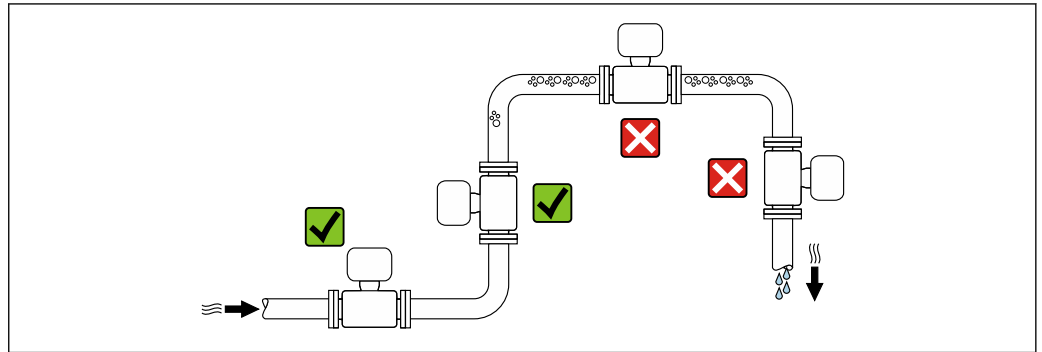

A0028772

To prevent measuring errors arising from accumulation of gas bubbles in the measuring tube, avoid the following mounting locations in the pipe:

- Highest point of a pipeline.
- Directly upstream of a free pipe outlet in a down pipe.

Installation in down pipes

However, the following installation suggestion allows for installation in an open vertical pipeline. Pipe restrictions or the use of an orifice with a smaller cross-section than the nominal diameter prevent the sensor running empty while measurement is in progress.

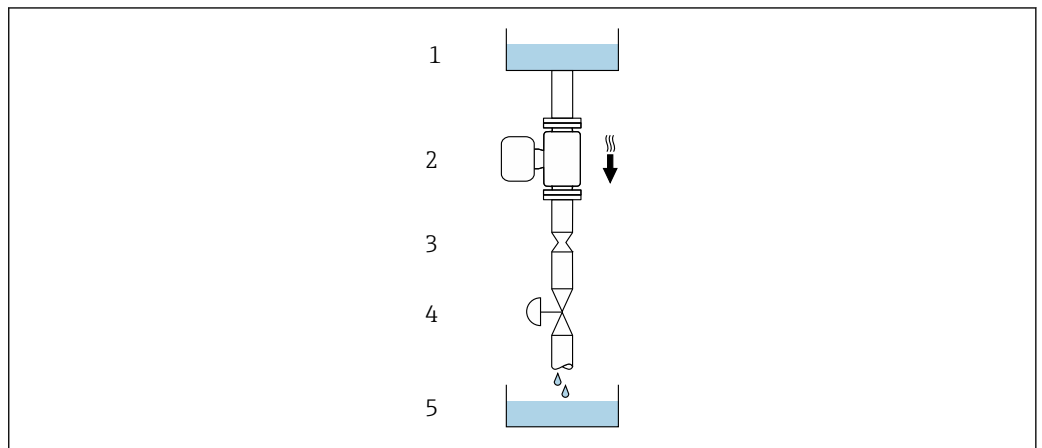

A0028773

9 Installation in a down pipe (e.g. for batching applications)

- 1 Supply tank
- 2 Sensor
- 3 Orifice plate, pipe restriction
- 4 Valve
- 5 Batching tank

DN		Ø orifice plate, pipe restriction	
[mm]	[in]	[mm]	[in]
8	3/8	6	0.24
15	1/2	10	0.40
25	1	14	0.55
40	1 1/2	22	0.87
50	2	28	1.10

Orientation

The direction of the arrow on the sensor nameplate helps you to install the sensor according to the flow direction (direction of medium flow through the piping).

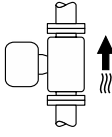
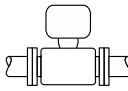
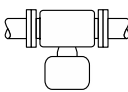
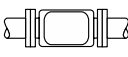
Orientation			Recommendation
A	Vertical orientation	 A0015591	☑☑
B	Horizontal orientation, transmitter at top	 A0015589	☑☑ ¹⁾ Exceptions: → ☒ 10, ☒ 32
C	Horizontal orientation, transmitter at bottom	 A0015590	☑☑ ²⁾ Exceptions: → ☒ 10, ☒ 32
D	Horizontal orientation, transmitter at side	 A0015592	☒

- 1) Applications with low process temperatures may decrease the ambient temperature. To maintain the minimum ambient temperature for the transmitter, this orientation is recommended.
- 2) Applications with high process temperatures may increase the ambient temperature. To maintain the maximum ambient temperature for the transmitter, this orientation is recommended.

If a sensor is installed horizontally with a curved measuring tube, match the position of the sensor to the fluid properties.

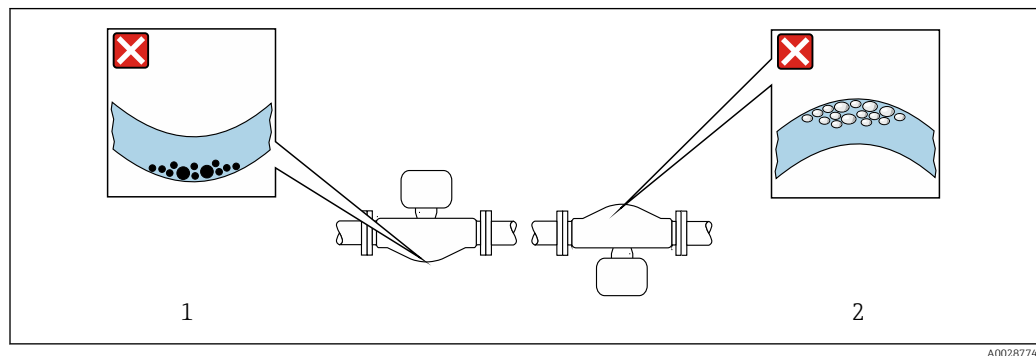

☒ 10 Orientation of sensor with curved measuring tube

- 1 Avoid this orientation for fluids with entrained solids: Risk of solids accumulating.
- 2 Avoid this orientation for outgassing fluids: Risk of gas accumulating.

Inlet and outlet runs

No special precautions need to be taken for fittings which create turbulence, such as valves, elbows or T-pieces, as long as no cavitation occurs → ☒ 38.

Special mounting instructions

Rupture disk

Information that is relevant to the process: → ☒ 38.

The position of the rupture disk is indicated on a sticker applied over it. If the rupture disk is triggered, the sticker is destroyed. The disk can therefore be visually monitored.

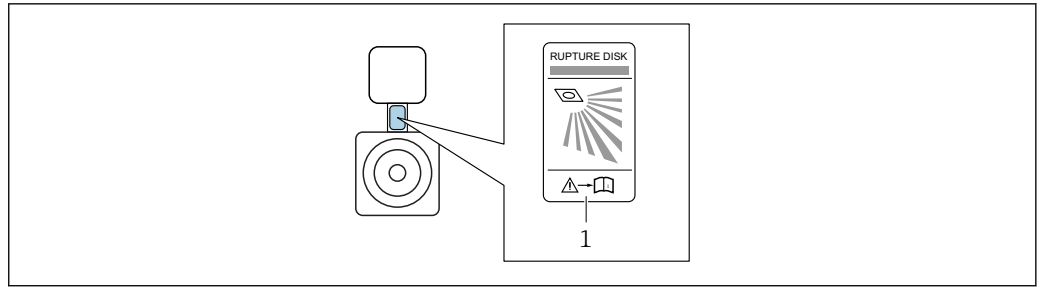

A0032051

1 Rupture disk label

Zero point adjustment

All measuring devices are calibrated in accordance with state-of-the-art technology. Calibration takes place under reference conditions → 27. Therefore, a zero point adjustment in the field is generally not required.

Experience shows that zero point adjustment is advisable only in special cases:

- To achieve maximum measuring accuracy even with low flow rates.
- Under extreme process or operating conditions (e.g. very high process temperatures or very high-viscosity fluids).

Environment

Ambient temperature range	Measuring device	-40 to +60 °C (-40 to +140 °F)
	Readability of the local display	-20 to +60 °C (-4 to +140 °F) The readability of the display may be impaired at temperatures outside the temperature range.

- ▶ If operating outdoors:
Avoid direct sunlight, particularly in warm climatic regions.

 You can order a weather protection cover from Endress+Hauser : → 66

Storage temperature	-40 to +80 °C (-40 to +176 °F), preferably at +20 °C (+68 °F)
----------------------------	---

Climate class	DIN EN 60068-2-38 (test Z/AD)
----------------------	-------------------------------

Degree of protection	Transmitter
	<ul style="list-style-type: none"> ■ As standard: IP66/67, type 4X enclosure ■ When housing is open: IP20, type 1 enclosure ■ Display module: IP20, type 1 enclosure
	Sensor
	IP66/67, type 4X enclosure
	Connector
	IP67, only in screwed situation

Vibration resistance	<ul style="list-style-type: none"> ■ Vibration, sinusoidal according to IEC 60068-2-6 <ul style="list-style-type: none"> - 2 to 8.4 Hz, 3.5 mm peak - 8.4 to 2 000 Hz, 1 g peak ■ Vibration broad-band random, according to IEC 60068-2-64 <ul style="list-style-type: none"> - 10 to 200 Hz, 0.003 g²/Hz - 200 to 2 000 Hz, 0.001 g²/Hz - Total: 1.54 g rms
-----------------------------	---

Shock resistance	Shock, half-sine according to IEC 60068-2-27 6 ms 30 g
Impact resistance	Rough handling shocks according to IEC 60068-2-31
Interior cleaning	<ul style="list-style-type: none"> ■ Cleaning in place (CIP) ■ Sterilization in place (SIP) Options Oil- and grease-free version for wetted parts, without inspection certificate Order code for "Service", option HA
Electromagnetic compatibility (EMC)	As per IEC/EN 61326 and NAMUR Recommendation 21 (NE 21)  For details, refer to the Declaration of Conformity.

Process

Medium temperature range	Sensor -40 to +150 °C (-40 to +302 °F) Seals No internal seals
---------------------------------	---

Density	0 to 2 000 kg/m ³ (0 to 125 lb/cf)
----------------	---

Pressure-temperature ratings	The following pressure/temperature diagrams apply to all pressure-bearing parts of the device and not just the process connection.
-------------------------------------	--

Flange according to EN 1092-1 (DIN 2501)

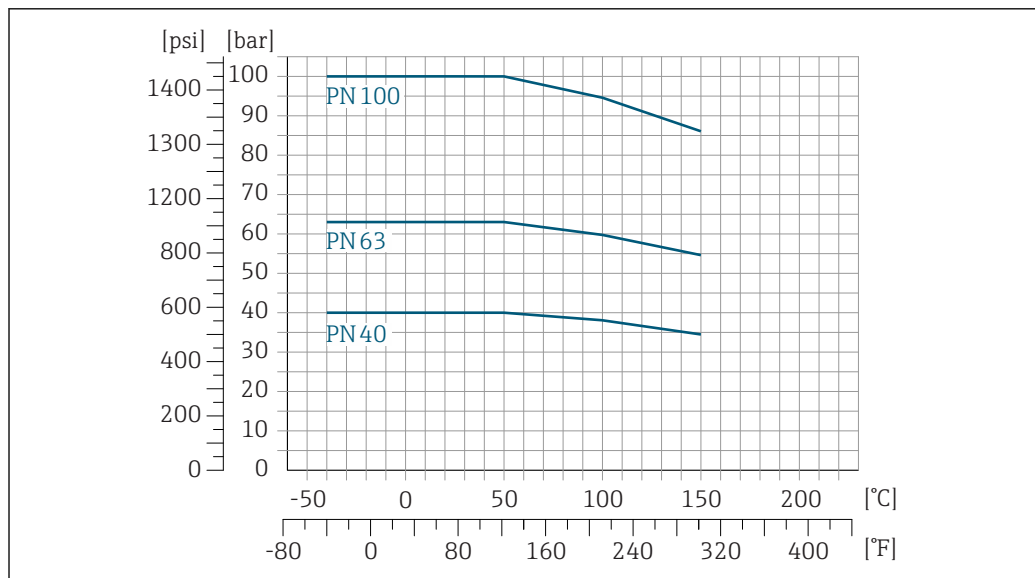

 11 With flange material 1.4404 (F316/F316L)

A0029832-EN

Flange according to ASME B16.5

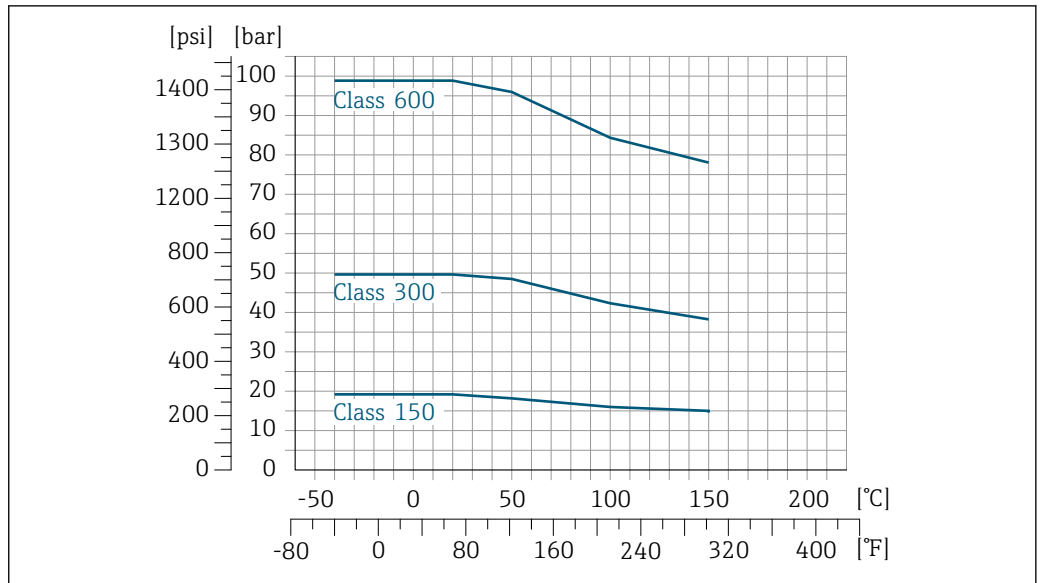

12 With flange material 1.4404 (F316/F316L)

Flange JIS B2220

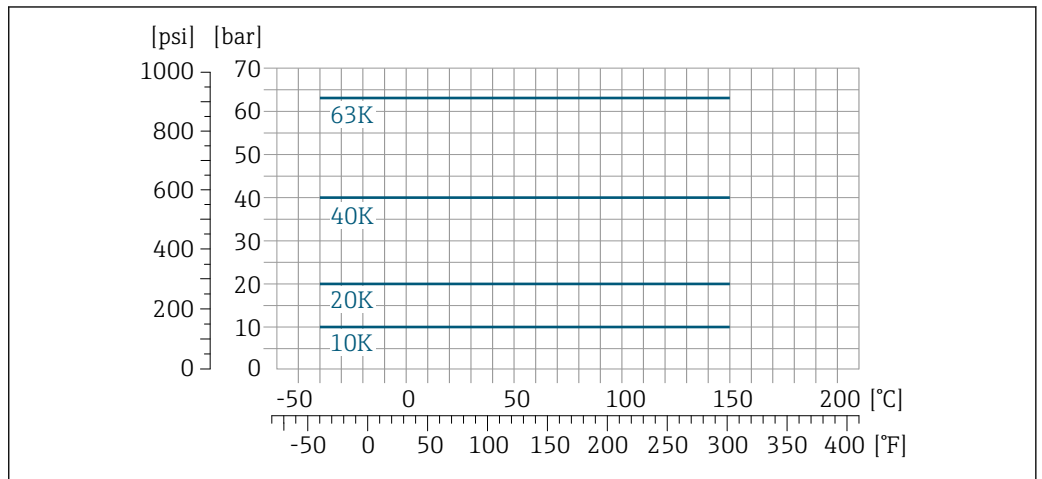

13 With flange material 1.4404 (F316/F316L)

Flange DIN 11864-2 Form A

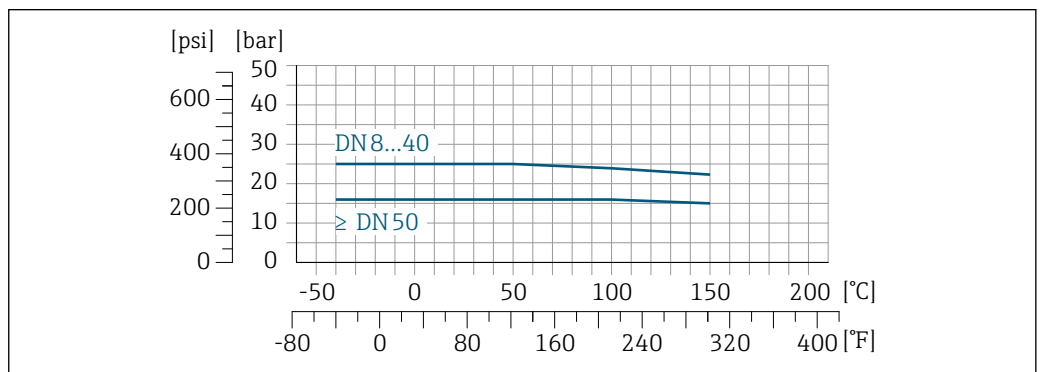

14 With flange material 1.4404 (316/316L)

Thread DIN 11851

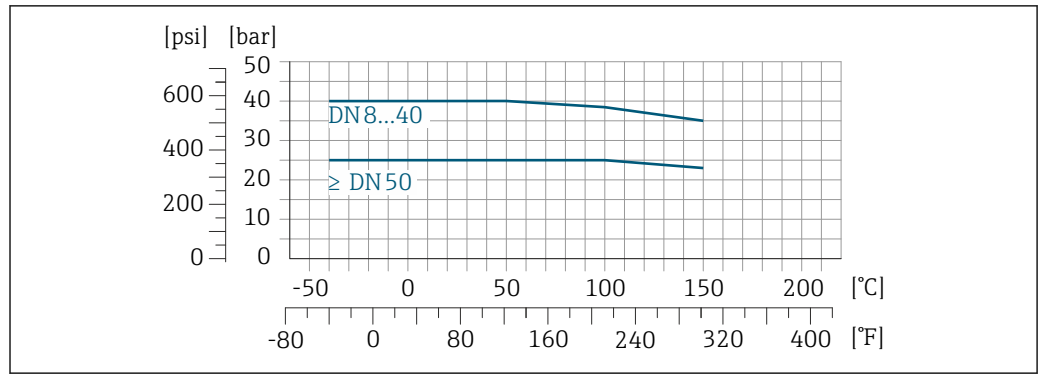

15 With connection material 1.4404 (316/316L)

DIN 11851 allows for applications up to +140 °C (+284 °F) if suitable sealing materials are used. Please take this into account when selecting seals and counterparts, as these components can limit the pressure and temperature range.

Thread DIN 11864-1 Form A

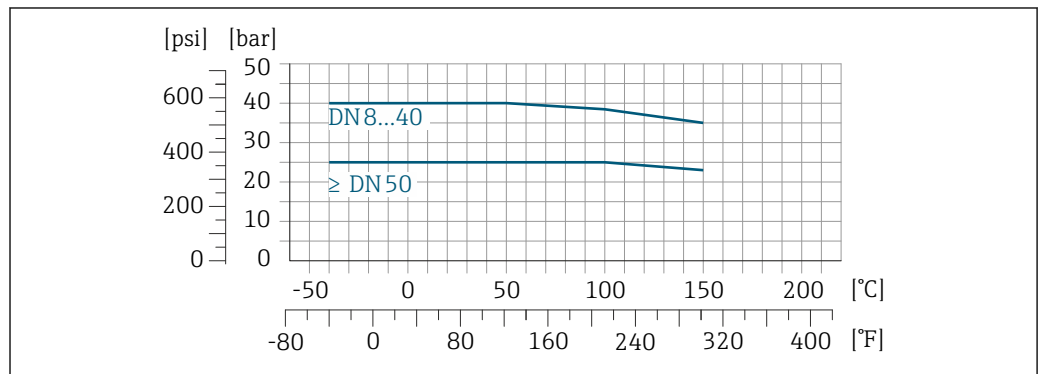

16 With connection material 1.4404 (316/316L)

Thread ISO 2853

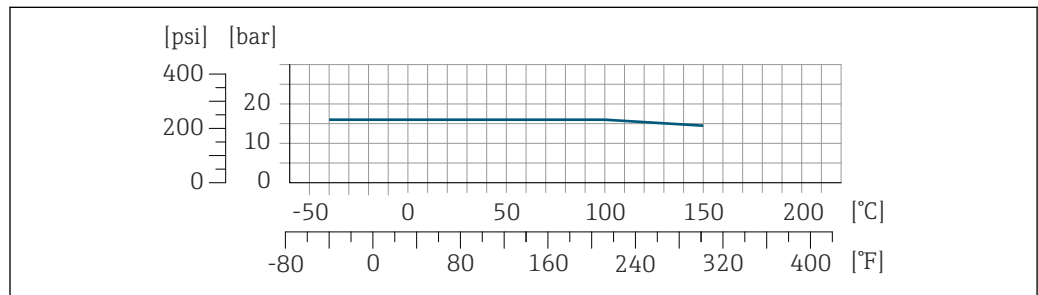

17 With connection material 1.4404 (316/316L)

Thread SMS 1145

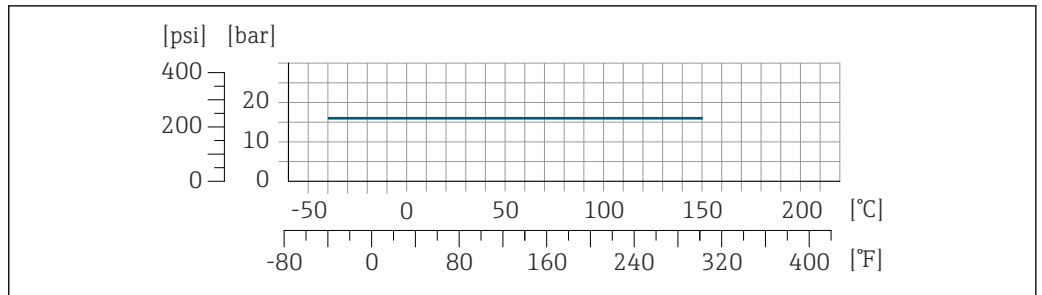

A0032218-EN

18 With connection material 1.4404 (316/316L)

SMS 1145 allows for applications up to 16 bar (232 psi) if suitable sealing materials are used. Please take this into account when selecting seals and counterparts, as these components can limit the pressure and temperature range.

VCO

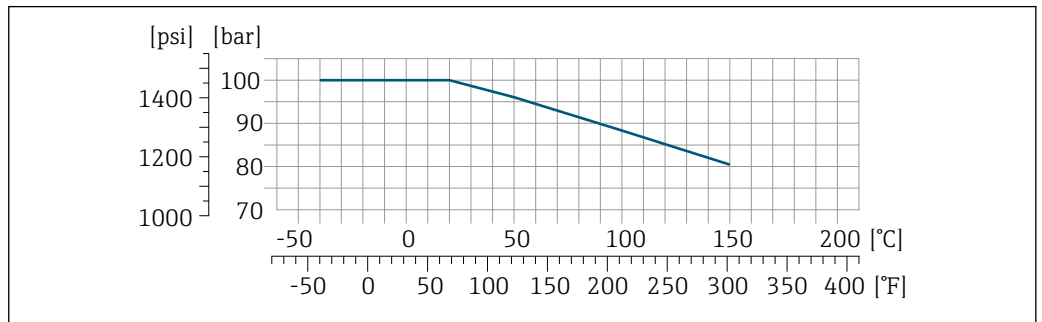

A0029863-EN

19 With connection material 1.4404 (316/316L)

Tri-Clamp

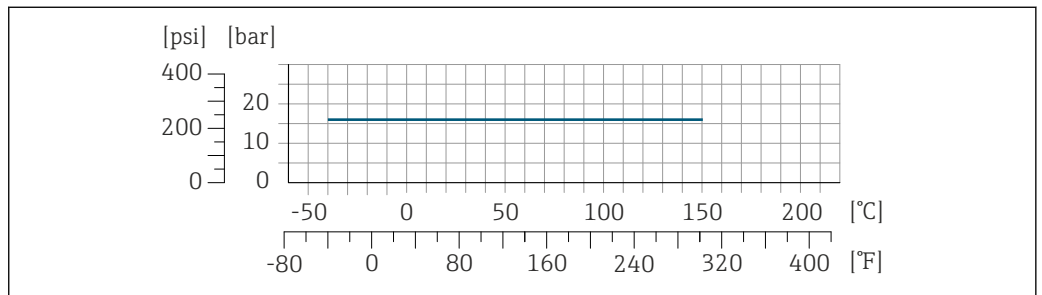

A0032218-EN

The clamp connections are suitable up to a maximum pressure of 16 bar (232 psi). Please observe the operating limits of the clamp and seal used as they can be over 16 bar (232 psi). The clamp and seal are not included in the scope of supply.

Secondary containment

The sensor housing is filled with dry nitrogen gas and protects the electronics and mechanics inside.

The secondary containment does not have a pressure rating classification.

Reference value for the pressure loading capacity of the sensor housing: 16 bar (232 psi)

If the device is fitted with a rupture disk (order code for "Sensor option", option **CA** "Rupture disk"), the rupture disk trigger pressure is decisive for the maximum nominal pressure → 38.

i If a measuring tube fails (e.g. due to process characteristics like corrosive or abrasive fluids), the fluid will be contained by the secondary containment.

Rupture disk



To increase the level of safety, a device version with a rupture disk with a trigger pressure of 10 to 15 bar (145 to 217.5 psi) can be used (order code for "Sensor option", option **CA** "rupture disk").

Rupture disks cannot be combined with the separately available heating jacket.

Special mounting instructions: →  32



Flow limit

Select the nominal diameter by optimizing between the required flow range and permissible pressure loss.

 For an overview of the full scale values for the measuring range, see the "Measuring range" section →  7

- The minimum recommended full scale value is approx. 1/20 of the maximum full scale value
- In most applications, 20 to 50 % of the maximum full scale value can be considered ideal
- A low full scale value must be selected for abrasive media (such as liquids with entrained solids):
flow velocity < 1 m/s (< 3 ft/s).
- For gas measurement the following rules apply:
 - The flow velocity in the measuring tubes should not exceed half the sound velocity (0.5 Mach).
 - The maximum mass flow depends on the density of the gas: formula →  7

Pressure loss

 To calculate the pressure loss, use the *Applicator* sizing tool →  68

System pressure

It is important that cavitation does not occur, or that gases entrained in the liquids do not outgas. This is prevented by means of a sufficiently high system pressure.

For this reason, the following mounting locations are recommended:

- At the lowest point in a vertical pipe
- Downstream from pumps (no danger of vacuum)

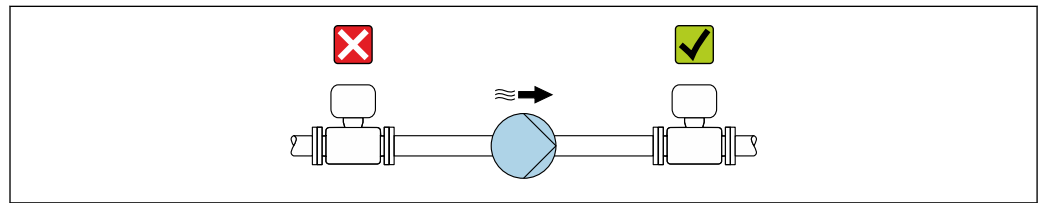

A0028777

Thermal insulation

In the case of some fluids, it is important that the heat radiated from the sensor to the transmitter is kept to a minimum. A wide range of materials can be used for the required insulation.

NOTICE**Danger of overheating with insulation**

- ▶ Ensure that the temperature at the lower end of the transmitter housing does not exceed 80 °C (176 °F)

NOTICE**The insulation can also be thicker than the maximum recommended insulation thickness.**

Prerequisite:

- ▶ Ensure that convection takes place on a sufficiently large scale at the transmitter neck.
- ▶ Ensure that a sufficiently large area of the housing support remains exposed. The uncovered part serves as a radiator and protects the electronics from overheating and excessive cooling.

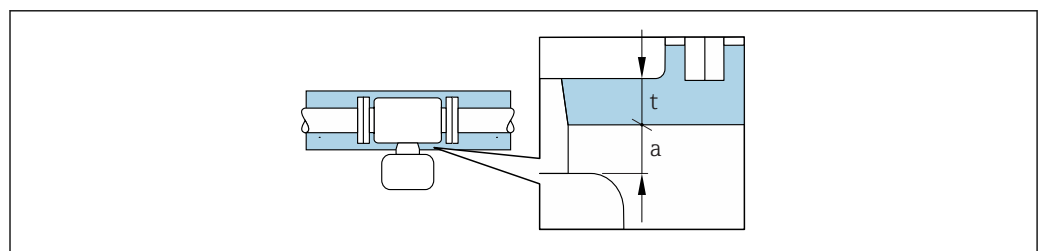

A0028853

t Maximum insulation thickness
a Minimum distance to insulation

The minimum distance between the transmitter and the insulation is 20 mm (0.79 in). This is to ensure that the transmitter remains completely exposed.

Maximum recommended insulation thickness

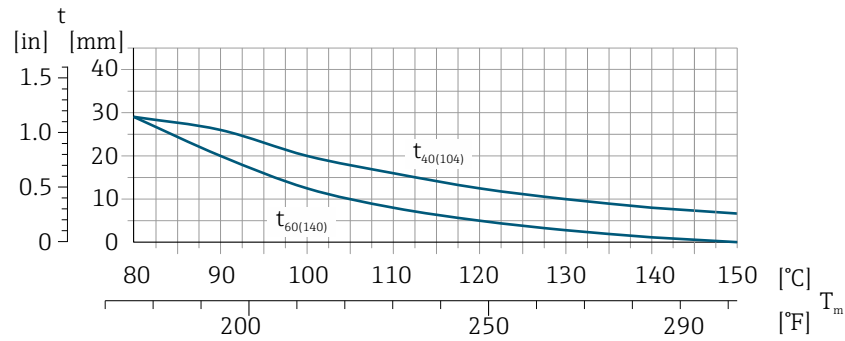

A0028904

20 *Maximum recommended insulation thickness depending on the temperature of the medium and the ambient temperature*

- t Insulation thickness
- T_m Medium temperature
- $t_{40(104)}$ Maximum recommended insulation thickness at an ambient temperature of $T_a = 40\text{ °C}$ (104 °F)
- $t_{60(140)}$ Maximum recommended insulation thickness at an ambient temperature of $T_a = 60\text{ °C}$ (140 °F)

Heating

Some fluids require suitable measures to avoid loss of heat at the sensor.

Heating options

- Electrical heating, e.g. with electric band heaters
- Via pipes carrying hot water or steam
- Via heating jackets

 Heating jackets for the sensors can be ordered as accessories from Endress+Hauser. →  66

NOTICE

Danger of overheating when heating

- ▶ Ensure that the temperature at the lower end of the transmitter housing does not exceed 80 °C (176 °F).
- ▶ Ensure that convection takes place on a sufficiently large scale at the transmitter neck.
- ▶ Ensure that a sufficiently large area of the housing support remains exposed. The uncovered part serves as a radiator and protects the electronics from overheating and excessive cooling.

Vibrations

The high oscillation frequency of the measuring tubes ensures that the correct operation of the measuring system is not influenced by plant vibrations.

Mechanical construction

Dimensions in SI units

Compact version

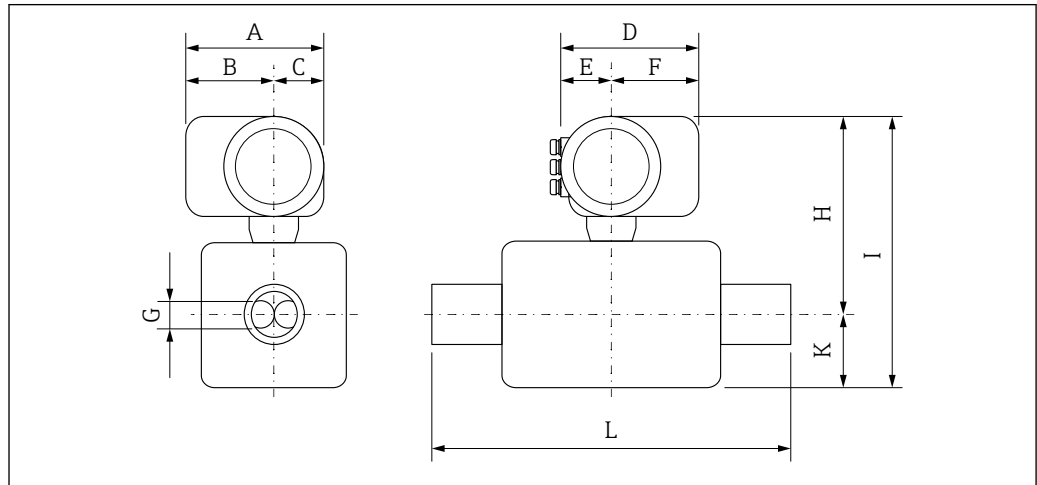

A0029786

Dimensions for version without overvoltage protection

Order code for "Housing", option C "GT20 two-chamber aluminum coated"

DN [mm]	A ¹⁾ [mm]	B ¹⁾ [mm]	C [mm]	D ²⁾ [mm]	E [mm]	F ²⁾ [mm]	G [mm]	H ³⁾ [mm]	I ³⁾ [mm]	K [mm]	L [mm]
8	162	102	60	165	75	90	5.35	261	350	89	⁴⁾
15	162	102	60	165	75	90	8.30	261	361	100	⁴⁾
25	162	102	60	165	75	90	12.0	258	360	102	⁴⁾
40	162	102	60	165	75	90	17.6	264	384	121	⁴⁾
50	162	102	60	165	75	90	26.0	278	453	176	⁴⁾

- 1) For version without local display: values - 7 mm
- 2) For version with overvoltage protection: values + 8 mm
- 3) For version without local display: values - 3 mm
- 4) Dependent on the respective process connection

Flange connections

Fixed flange EN 1092-1, ASME B16.5, JIS B2220

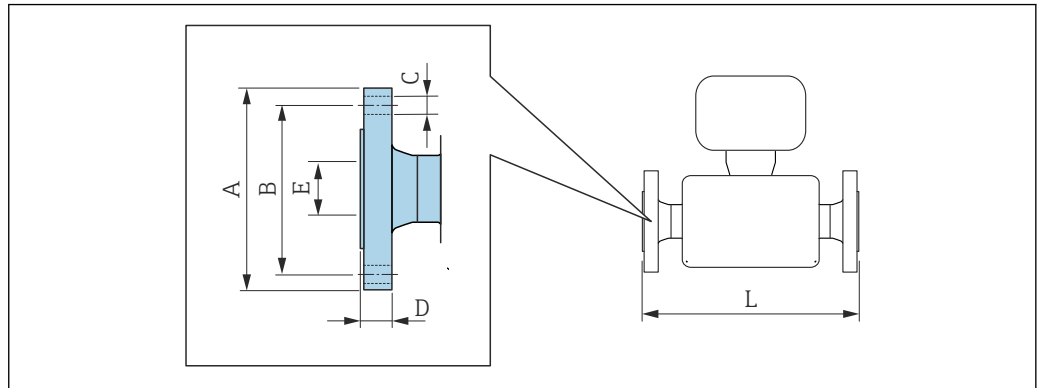

A0015621

i Length tolerance for dimension L in mm:
+1.5 / -2.0

Flange according to EN 1092-1 (DIN 2501 / DIN 2512N), PN 40						
1.4404 (F316/F316L): order code for "Process connection", option D2S						
Flange with groove according to EN 1092-1 Form D (DIN 2512N), PN 40						
1.4404 (F316/F316L): order code for "Process connection", option D6S						
DN [mm]	A [mm]	B [mm]	C [mm]	D [mm]	E [mm]	L [mm]
8 ¹⁾	95	65	4 × Ø14	16	17.3	232/510 ²⁾
15	95	65	4 × Ø14	16	17.3	279/510 ²⁾
25	115	85	4 × Ø14	18	28.5	329/600 ²⁾
40	150	110	4 × Ø18	18	43.1	445
50	165	125	4 × Ø18	20	54.5	556/715 ²⁾
Surface roughness (flange): EN 1092-1 Form B1 (DIN 2526 Form C), Ra 3.2 to 12.5 µm						

- 1) DN 8 with DN 15 flanges as standard
- 2) Installation length in accordance with NAMUR recommendation NE 132 optionally available (order code for "Process connection", option D2N or D6N (with groove))

Flange according to EN 1092-1 (DIN 2501), PN 40 (with DN 25 flanges)						
1.4404 (F316/F316L)						
<i>Order code for "Process connection", option R2S</i>						
DN [mm]	A [mm]	B [mm]	C [mm]	D [mm]	E [mm]	L [mm]
8	115	85	4 × Ø14	18	28.5	329
15	115	85	4 × Ø14	18	28.5	329
Surface roughness (flange): EN 1092-1 Form B1 (DIN 2526 Form C), Ra 3.2 to 12.5 µm						

Flange according to EN 1092-1 (DIN 2501 / DIN 2512N), PN 63 1.4404 (F316/F316L): order code for "Process connection", option D3S						
Flange with groove according to EN 1092-1 Form D (DIN 2512N), PN 63 1.4404 (F316/F316L): order code for "Process connection", option D7S						
DN [mm]	A [mm]	B [mm]	C [mm]	D [mm]	E [mm]	L [mm]
50	180	135	4 × Ø22	26	54.5	565
Surface roughness (flange): EN 1092-1 Form B2 (DIN 2526 Form E), Ra 0.8 to 3.2 µm						

Flange according to EN 1092-1 (DIN 2501 / DIN 2512N), PN 100 1.4404 (F316/F316L) Order code for "Process connection", option D4S						
Flange with groove according to EN 1092-1 Form D (DIN 2512N) available, PN 100 1.4404 (F316/F316L) Order code for "Process connection", option D8S						
DN [mm]	A [mm]	B [mm]	C [mm]	D [mm]	E [mm]	L [mm]
8 ¹⁾	105	75	4 × Ø14	20	17.3	261
15	105	75	4 × Ø14	20	17.3	295
25	140	100	4 × Ø18	24	28.5	360
40	170	125	4 × Ø22	26	42.5	486
50	195	145	4 × Ø26	28	53.9	581
Surface roughness (flange): EN 1092-1 Form B2 (DIN 2526 Form E), Ra 0.8 to 3.2 µm						

1) DN 8 with DN 15 flanges as standard

Flange according to ASME B16.5, Class 150 1.4404 (F316/F316L) Order code for "Process connection", option AAS						
DN [mm]	A [mm]	B [mm]	C [mm]	D [mm]	E [mm]	L [mm]
8 ¹⁾	90	60.3	4 × Ø15.7	11.2	15.7	232
15	90	60.3	4 × Ø15.7	11.2	15.7	279
25	110	79.4	4 × Ø15.7	14.2	26.7	329
40	125	98.4	4 × Ø15.7	17.5	40.9	445
50	150	120.7	4 × Ø19.1	19.1	52.6	556
Surface roughness (flange): Ra 3.2 to 6.3 µm						

1) DN 8 with DN 15 flanges as standard

Flange according to ASME B16.5, Class 300 1.4404 (F316/F316L) Order code for "Process connection", option ABS						
DN [mm]	A [mm]	B [mm]	C [mm]	D [mm]	E [mm]	L [mm]
8 ¹⁾	95	66.7	4 × Ø15.7	14.2	15.7	232
15	95	66.7	4 × Ø15.7	14.2	15.7	279
25	125	88.9	4 × Ø19.0	17.5	26.7	329
40	155	114.3	4 × Ø22.3	20.6	40.9	445

Flange according to ASME B16.5, Class 300 1.4404 (F316/F316L) <i>Order code for "Process connection", option ABS</i>						
DN [mm]	A [mm]	B [mm]	C [mm]	D [mm]	E [mm]	L [mm]
50	165	127	8 × Ø19.0	22.3	52.6	556
Surface roughness (flange): Ra 3.2 to 6.3 µm						

1) DN 8 with DN 15 flanges as standard

Flange according to ASME B16.5, Class 600 1.4404 (F316/F316L) <i>Order code for "Process connection", option ACS</i>						
DN [mm]	A [mm]	B [mm]	C [mm]	D [mm]	E [mm]	L [mm]
8 ¹⁾	95	66.7	4 × Ø15.7	20.6	13.9	261
15	95	66.7	4 × Ø15.7	20.6	13.9	295
25	125	88.9	4 × Ø19.1	23.9	24.3	380
40	155	114.3	4 × Ø22.4	28.7	38.1	496
50	165	127	8 × Ø19.1	31.8	49.2	583
Surface roughness (flange): Ra 3.2 to 6.3 µm						

1) DN 8 with DN 15 flanges as standard

Flange JIS B2220, 10K 1.4404 (F316/F316L) <i>Order code for "Process connection", option NDS</i>						
DN [mm]	A [mm]	B [mm]	C [mm]	D [mm]	E [mm]	L [mm]
50	155	120	4 × Ø19	16	50	556
Surface roughness (flange): Ra 3.2 to 6.3 µm						

Flange JIS B2220, 20K 1.4404 (F316/F316L) <i>Order code for "Process connection", option NES</i>						
DN [mm]	A [mm]	B [mm]	C [mm]	D [mm]	E [mm]	L [mm]
8 ¹⁾	95	70	4 × Ø15	14	15	232
15	95	70	4 × Ø15	14	15	279
25	125	90	4 × Ø19	16	25	329
40	140	105	4 × Ø19	18	40	445
50	155	120	8 × Ø19	18	50	556
Surface roughness (flange): Ra 3.2 to 6.3 µm						

1) DN 8 with DN 15 flanges as standard

Flange JIS B2220, 40K 1.4404 (F316/F316L) <i>Order code for "Process connection", option NGS</i>						
DN [mm]	A [mm]	B [mm]	C [mm]	D [mm]	E [mm]	L [mm]
8 ¹⁾	115	80	4 × Ø19	20	15	261
15	115	80	4 × Ø19	20	15	300
25	130	95	4 × Ø19	22	25	375
40	160	120	4 × Ø23	24	38	496
50	165	130	8 × Ø19	26	50	601
Surface roughness (flange): Ra 3.2 to 6.3 µm						

- 1) DN 8 with DN 15 flanges as standard

Flange JIS B2220, 63K 1.4404 (F316/F316L) <i>Order code for "Process connection", option NHS</i>						
DN [mm]	A [mm]	B [mm]	C [mm]	D [mm]	E [mm]	L [mm]
8 ¹⁾	120	85	4 × Ø19	23	12	282
15	120	85	4 × Ø19	23	12	315
25	140	100	4 × Ø23	27	22	383
40	175	130	4 × Ø25	32	35	515
50	185	145	4 × Ø23	34	48	616
Surface roughness (flange): Ra 3.2 to 6.3 µm						

- 1) DN 8 with DN 15 flanges as standard

Fixed flange DIN 11864-2

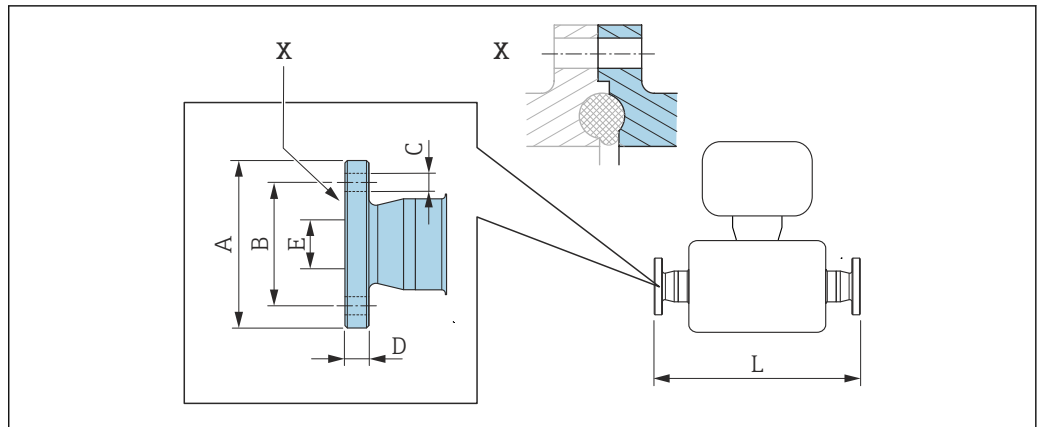

A0015627

21 Detail X: Asymmetrical process connection; the part shown in blue is provided by the supplier.

i Length tolerance for dimension L in mm:
+1.5 / -2.0

Flange DIN11864-2 Form A, for pipe according to DIN11866 series A, flat flange 1.4404 (316/316L)

Order code for "Process connection", option KCS

DN [mm]	A [mm]	B [mm]	C [mm]	D [mm]	E [mm]	L [mm]
8	54	37	4 × Ø9	10	10	249
15	59	42	4 × Ø9	10	16	293
25	70	53	4 × Ø9	10	26	344
40	82	65	4 × Ø9	10	38	456
50	94	77	4 × Ø9	10	50	562

3-A version available: order code for "Additional approval", option LP in conjunction with
 Ra ≤ 0.8 µm: Order code for "Measuring tube material", option SB
 Ra ≤ 0.4 µm: Order code for "Measuring tube material", option SC

Clamp connections

Tri-Clamp

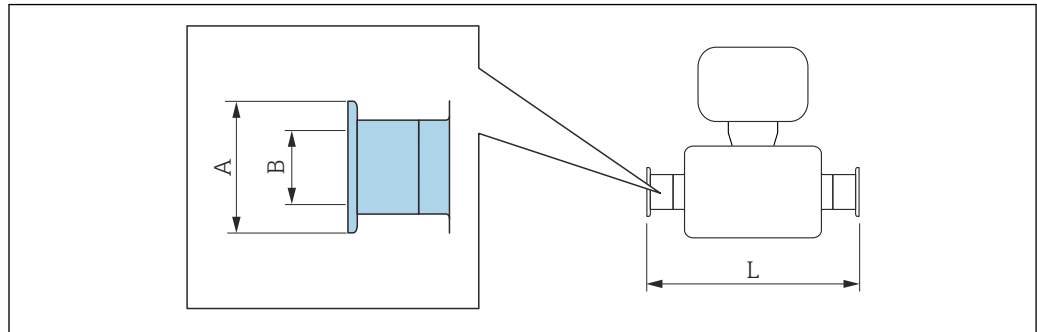

A0015625

i Length tolerance for dimension L in mm:
+1.5 / -2.0

Tri-Clamp (½") 1.4404 (316/316L) Order code for "Process connection", option FDW				
DN [mm]	Clamp [in]	A [mm]	B [mm]	L [mm]
8	½	25.0	9.5	229
15	½	25.0	9.5	273

3-A version available: order code for "Additional approval", option LP in conjunction with
 Ra ≤ 0.8 µm: Order code for "Measuring tube material", option **SB**
 Ra ≤ 0.4 µm: Order code for "Measuring tube material", option **SC**

Tri-Clamp (≥ 1") 1.4404 (316/316L) Order code for "Process connection", option FTS				
DN [mm]	Clamp [in]	A [mm]	B [mm]	L [mm]
8	1	50.4	22.1	229
15	1	50.4	22.1	273
25	1	50.4	22.1	324
40	1½	50.4	34.8	456
50	2	63.9	47.5	562

3-A version available: order code for "Additional approval", option LP in conjunction with
 Ra ≤ 0.8 µm: Order code for "Measuring tube material", option **SB**
 Ra ≤ 0.4 µm: Order code for "Measuring tube material", option **SC**

Threaded connections

Thread DIN 11851, DIN11864-1, SMS 1145

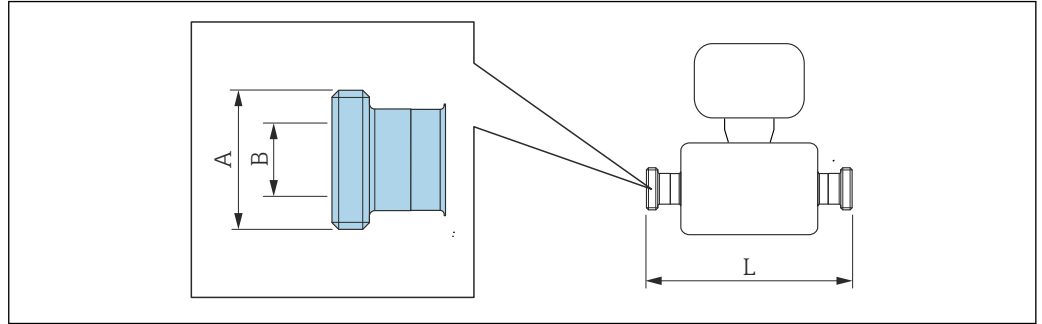

A0015628

i Length tolerance for dimension L in mm:
+1.5 / -2.0

Thread DIN 11851, for pipe according to DIN11866, series A 1.4404 (316/316L) Order code for "Process connection", option FMW			
DN [mm]	A [in]	B [mm]	L [mm]
8	Rd 34 × 1/8	16	229
15	Rd 34 × 1/8	16	273
25	Rd 52 × 1/6	26	324
40	Rd 65 × 1/6	38	456
50	Rd 78 × 1/6	50	562

3-A version available: order code for "Additional approval", option LP in conjunction with
 Ra ≤ 0.8 µm: Order code for "Measuring tube material", option SB
 Ra ≤ 0.4 µm: Order code for "Measuring tube material", option SC

Thread DIN11864-1 Form A, for pipe according to DIN11866, series A 1.4404 (316/316L) Order code for "Process connection", option FLW			
DN [mm]	A [in]	B [mm]	L [mm]
8	Rd 28 × 1/8	10	229
15	Rd 34 × 1/8	16	273
25	Rd 52 × 1/6	26	324
40	Rd 65 × 1/6	38	456
50	Rd 78 × 1/6	50	562

3-A version available: order code for "Additional approval", option LP in conjunction with
 Ra ≤ 0.8 µm: Order code for "Measuring tube material", option SB
 Ra ≤ 0.4 µm: Order code for "Measuring tube material", option SC

Thread SMS 1145 1.4404 (316/316L) <i>Order code for "Process connection", option SCS</i>			
DN [mm]	A [in]	B [mm]	L [mm]
8	Rd $40 \times \frac{1}{6}$	22.5	229
15	Rd $40 \times \frac{1}{6}$	22.5	273
25	Rd $40 \times \frac{1}{6}$	22.5	324
40	Rd $60 \times \frac{1}{6}$	35.5	456
50	Rd $70 \times \frac{1}{6}$	48.5	562
3-A version available: order code for "Additional approval", option LP in conjunction with Ra ≤ 0.8 µm: Order code for "Measuring tube material", option SB Ra ≤ 0.4 µm: Order code for "Measuring tube material", option SC			

Thread ISO 2853

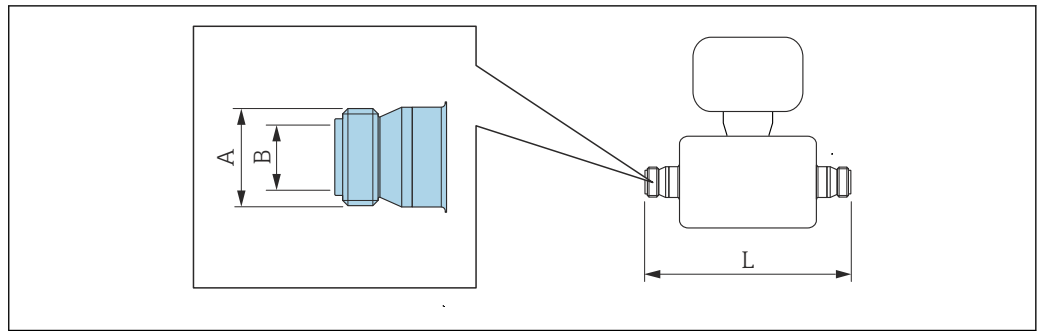

A0015623

 Length tolerance for dimension L in mm:
+1.5 / -2.0

Thread ISO 2853, for pipe according to ISO 2037 1.4404 (316/316L) Order code for "Process connection", option JSF			
DN [mm]	A ¹⁾ [mm]	B [mm]	L [mm]
8	37.13	22.6	229
15	37.13	22.6	273
25	37.13	22.6	324
40	50.68	35.6	456
50	64.16	48.6	562

3-A version available: order code for "Additional approval", option LP in conjunction with
 Ra ≤ 0.8 µm: Order code for "Measuring tube material", option SB
 Ra ≤ 0.4 µm: Order code for "Measuring tube material", option SC

1) Max. thread diameter as per ISO 2853 annex A

VCO

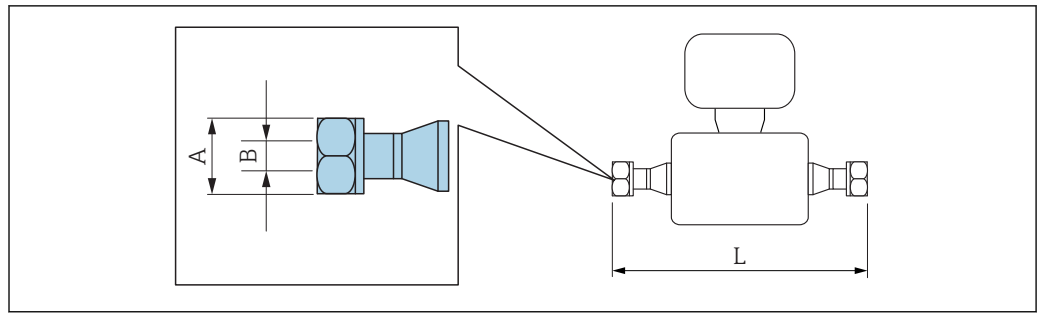

A0015624

i Length tolerance for dimension L in mm:
+1.5 / -2.0

8-VCO-4 (1/2") 1.4404 (316/316L) Order code for "Process connection", option CVS			
DN [mm]	A [in]	B [mm]	L [mm]
8	AF 1	10.2	252

12-VCO-4 (3/4") 1.4404 (316/316L) Order code for "Process connection", option CWS			
DN [mm]	A [in]	B [mm]	L [mm]
15	AF 1½	15.7	305

Dimensions in US units

Compact version

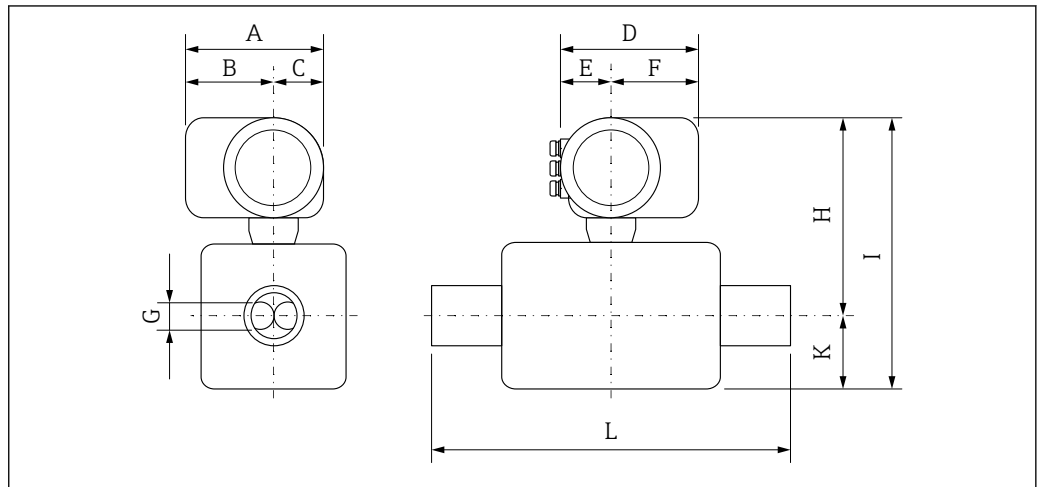

A0029786

Dimensions for version without overvoltage protection

Order code for "Housing", option C "GT20 two-chamber aluminum coated"

DN [in]	A ¹⁾ [in]	B ¹⁾ [in]	C [in]	D ²⁾ [in]	E [in]	F ²⁾ [in]	G [in]	H ³⁾ [in]	I ³⁾ [in]	K [in]	L [in]
8	6.38	4.02	2.36	6.5	2.95	3.54	0.211	10.28	13.78	3.5	⁴⁾
15	6.38	4.02	2.36	6.5	2.95	3.54	0.33	10.28	14.21	3.94	⁴⁾
25	6.38	4.02	2.36	6.5	2.95	3.54	0.47	10.16	14.17	4.02	⁴⁾
40	6.38	4.02	2.36	6.5	2.95	3.54	0.69	10.39	15.12	4.76	⁴⁾
50	6.38	4.02	2.36	6.5	2.95	3.54	1.02	10.94	17.83	6.93	⁴⁾

- 1) For version without local display: values - 0.28 in
- 2) For version with overvoltage protection: values + 0.31 in
- 3) For version without local display: values - 0.11 in
- 4) Dependent on the respective process connection

Flange connections

Fixed flange ASME B16.5

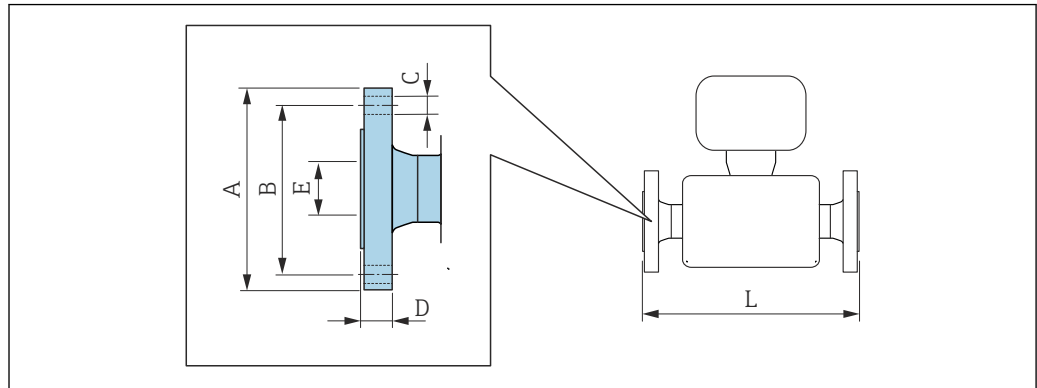

A0015621

i Length tolerance for dimension L in inch:
+0.06 / -0.08

Flange according to ASME B16.5, CI 150 1.4404 (F316/F316L) Order code for "Process connection", option AAS						
DN [in]	A [in]	B [in]	C [in]	D [in]	E [in]	L [in]
3/8 ¹⁾	3.54	2.37	4 × Ø0.62	0.44	0.62	9.13
1/2	3.54	2.37	4 × Ø0.62	0.44	0.62	10.98
1	4.33	3.13	4 × Ø0.62	0.56	1.05	12.95
1½	4.92	3.87	4 × Ø0.62	0.69	1.61	17.52
2	5.91	4.75	4 × Ø0.75	0.75	2.07	21.89

Surface roughness (flange): Ra 32 to 248 µin

1) DN 3/8" with DN 1/2" flanges as standard

Flange according to ASME B16.5, Class 300 1.4404 (F316/F316L) Order code for "Process connection", option ABS						
DN [in]	A [in]	B [in]	C [in]	D [in]	E [in]	L [in]
3/8 ¹⁾	3.74	2.63	4 × Ø0.62	0.56	0.62	9.13
1/2	3.74	2.63	4 × Ø0.62	0.56	0.62	10.98
1	4.92	3.50	4 × Ø0.75	0.69	1.05	12.95
1½	6.10	4.50	4 × Ø0.88	0.81	1.61	17.52
2	6.50	5.00	8 × Ø0.75	0.88	2.07	21.89

Surface roughness (flange): Ra 32 to 248 µin

1) DN 3/8" with DN 1/2" flanges as standard

Flange according to ASME B16.5, Class 600 1.4404 (F316/F316L) <i>Order code for "Process connection", option ACS</i>						
DN [in]	A [in]	B [in]	C [in]	D [in]	E [in]	L [in]
$\frac{3}{8}$ ¹⁾	3.74	2.63	4 × Ø0.62	0.81	0.55	10.28
$\frac{1}{2}$	3.74	2.63	4 × Ø0.62	0.81	0.55	11.61
1	4.92	3.50	4 × Ø0.75	0.94	0.96	14.96
1½	6.10	4.50	4 × Ø0.88	1.13	1.50	19.53
2	6.50	5.00	8 × Ø0.75	1.25	1.94	22.95
Surface roughness (flange): Ra 32 to 248 µin						

1) DN $\frac{3}{8}$ " with DN $\frac{1}{2}$ " flanges as standard

Clamp connections

Tri-Clamp

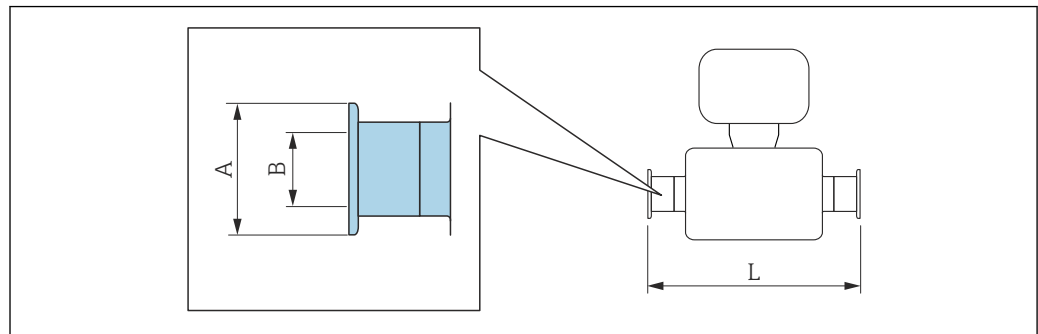

A0015625

i Length tolerance for dimension L in inch:
+0.06 / -0.08

Tri-Clamp (½") 1.4404 (316/316L) Order code for "Process connection", option FDW				
DN [in]	Clamp [in]	A [in]	B [in]	L [in]
3/8	1/2	0.98	0.37	9.02
1/2	1/2	0.98	0.37	10.75

3-A version available: order code for "Additional approval", option LP in conjunction with
 Ra ≤ 32 µin: Order code for "Measuring tube material", option **SB**
 Ra ≤ 16 µin: Order code for "Measuring tube material", option **SC**

Tri-Clamp (≥ 1") 1.4404 (316/316L) Order code for "Process connection", option FTS				
DN [in]	Clamp [in]	A [in]	B [in]	L [in]
3/8	1	1.98	0.87	9.02
1/2	1	1.98	0.87	10.75
1	1	1.98	0.87	12.76
1½	1½	1.98	1.37	17.95
2	2	2.52	1.87	22.13

3-A version available: order code for "Additional approval", option LP in conjunction with
 Ra ≤ 32 µin: Order code for "Measuring tube material", option **SB**
 Ra ≤ 16 µin: Order code for "Measuring tube material", option **SC**

Threaded connections

Thread SMS 1145

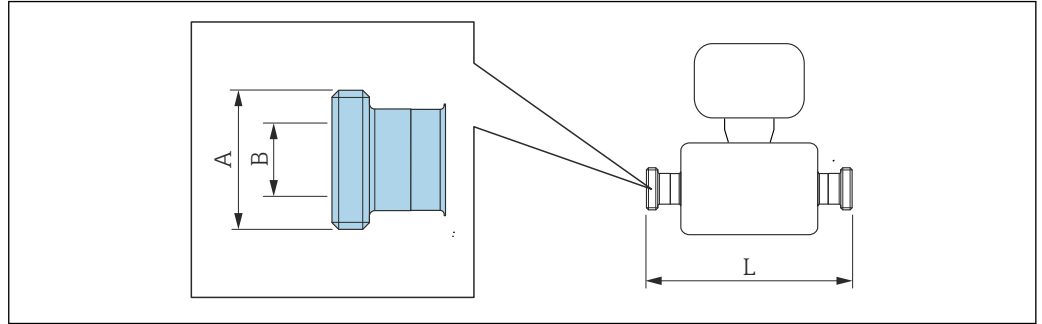

A0015628

i Length tolerance for dimension L in inch:
+0.06 / -0.08

Thread SMS 1145 1.4404 (316/316L) Order code for "Process connection", option SCS			
DN [in]	A [in]	B [in]	L [in]
3/8	Rd 40 × 1/6	0.89	9.02
1/2	Rd 40 × 1/6	0.89	10.75
1	Rd 40 × 1/6	0.89	12.76
1 1/2	Rd 60 × 1/6	1.40	17.95
2	Rd 70 × 1/6	1.91	22.13

3-A version available: order code for "Additional approval", option LP in conjunction with
 Ra ≤ 32 μin: Order code for "Measuring tube material", option **SB**
 Ra ≤ 16 μin: Order code for "Measuring tube material", option **SC**

VCO

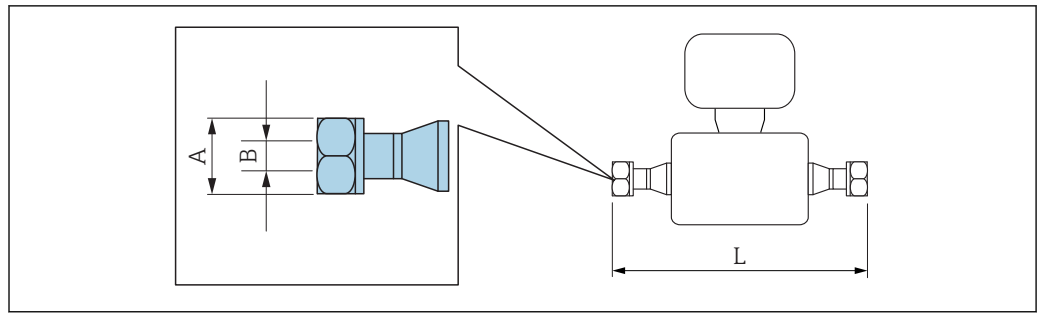

A0015624

i Length tolerance for dimension L in inch:
+0.06 / -0.08

8-VCO-4 (1/2")			
1.4404 (316/316L)			
Order code for "Process connection", option CVS			
DN [in]	A [in]	B [in]	L [in]
3/8	AF 1	0.40	9.92

12-VCO-4 (3/4")			
1.4404 (316/316L)			
Order code for "Process connection", option CWS			
DN [in]	A [in]	B [in]	L [in]
1/2	AF 1 1/2	0.62	12.01

Weight

All values (weight) refer to devices with EN/DIN PN 40 flanges.

Weight in SI units

DN [mm]	Weight [kg]
8	5
15	5.5
25	7
40	11
50	16

Weight in US units

DN [in]	Weight [lbs]
3/8	11
1/2	12
1	15
1 1/2	24
2	35

Materials

Transmitter housing

- Order code for "Housing", option C "Compact, aluminum coated":
Aluminum, AlSi10Mg, coated
- Window material: glass

Cable entries/cable glands

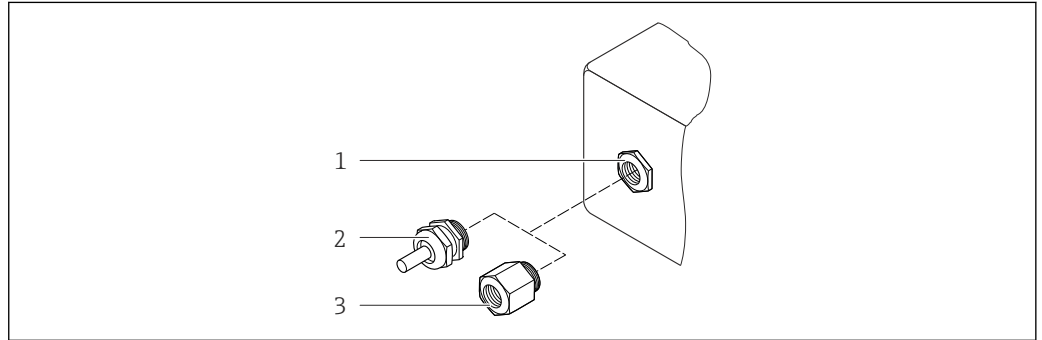

22 Possible cable entries/cable glands

- 1 Cable entry with M20 × 1.5 internal thread
- 2 Cable gland M20 × 1.5
- 3 Adapter for cable entry with internal thread G ½" or NPT ½"

Order code for "Housing", option C "GT20 dual compartment, aluminum coated"

Cable entry/cable gland	Type of protection	Material
Cable gland M20 × 1.5	<ul style="list-style-type: none"> ■ Non-Ex ■ Ex ia ■ Ex ic 	Plastic
	Adapter for cable entry with internal thread G ½"	Nickel-plated brass
Adapter for cable entry with internal thread NPT ½"	For non-Ex and Ex (except for CSA Ex d/XP)	Nickel-plated brass
Thread NPT ½" via adapter	For non-Ex and Ex	

Device plug

Electrical connection	Material
Plug M12x1	<ul style="list-style-type: none"> ■ Socket: stainless steel, 1.4401/316 ■ Contact housing: plastic, PUR, black ■ Contacts: metal, CuZn, gold-plated ■ Threaded connection seal: NBR

Sensor housing

- Acid and alkali-resistant outer surface
- Stainless steel 1.4301 (304)

Measuring tubes

Stainless steel, 1.4539 (904L); manifold: stainless steel, 1.4404 (316L)

Process connections

- Flanges according to EN 1092-1 (DIN2501) / according to ASME B 16.5 / as per JIS B2220: Stainless steel, 1.4404 (F316/F316L)
- All other process connections: Stainless steel, 1.4404 (316/316L)



List of all available process connections → 58

Seals

Welded process connections without internal seals

Accessories

Protective cover

Stainless steel, 1.4404 (316L)

Process connections

- Fixed flange connections:
 - EN 1092-1 (DIN 2501) flange
 - EN 1092-1 (DIN 2512N) flange
 - Namur lengths in accordance with NE 132
 - ASME B16.5 flange
 - JIS B2220 flange
 - DIN 11864-2 Form A flange, DIN11866 series A, flange with notch
- Clamp connections
 - Tri-Clamp (OD tubes), DIN 11866 series C
- Threads:
 - DIN 11851 thread, DIN11866 series A
 - SMS 1145 thread
 - ISO 2853 thread, ISO2037
 - DIN 11864-1 Form A thread, DIN11866 series A
- VCO connections
 - 8-VCO-4
 - 12-VCO-4



For information on the different materials used in the process connections

Surface roughness

All data relate to parts in contact with fluid. The following surface roughness quality can be ordered.

- Not polished
- $Ra_{max} = 0.8 \mu\text{m}$ (32 μin)
- $Ra_{max} = 0.4 \mu\text{m}$ (16 μin)

Operability

Operating concept**Operator-oriented menu structure for user-specific tasks**

- Commissioning
- Operation
- Diagnostics
- Expert level

Quick and safe commissioning

- Guided menus ("Make-it-run" wizards) for applications
- Menu guidance with brief explanations of the individual parameter functions

Reliable operation

- Operation in the following languages:
 - Via local display: English, German, French, Spanish, Italian, Dutch, Portuguese, Polish, Russian, Swedish, Turkish, Chinese, Japanese, Bahasa (Indonesian), Vietnamese, Czech
 - Via "FieldCare" operating tool: English, German, French, Spanish, Italian, Chinese, Japanese
- Uniform operating philosophy applied to device and operating tools
- If replacing the electronic module, transfer the device configuration via the integrated memory (integrated HistoROM) which contains the process and measuring device data and the event logbook. No need to reconfigure.

Efficient diagnostics increase measurement availability

- Troubleshooting measures can be called up via the device and in the operating tools
- Diverse simulation options, logbook for events that occur and optional line recorder functions

Languages

Can be operated in the following languages:

- Via local display: English, German, French, Spanish, Italian, Dutch, Portuguese, Polish, Russian, Swedish, Turkish, Chinese, Japanese, Bahasa (Indonesian), Vietnamese, Czech
- Via "FieldCare" operating tool: English, German, French, Spanish, Italian, Chinese, Japanese

Local operation

Via display module

Two display modules are available:

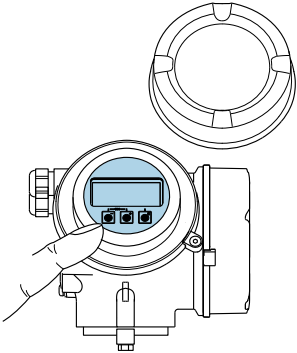
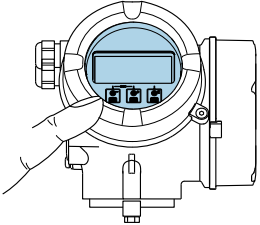
Order code for "Display; Operation", option C "SD02"	Order code for "Display; Operation", option E "SD03"
	
1 Operation with pushbuttons	1 Operation with touch control

Display elements

- 4-line, illuminated, graphic display
- White background lighting; switches to red in event of device errors
- Format for displaying measured variables and status variables can be individually configured
- Permitted ambient temperature for the display: -20 to +60 °C (-4 to +140 °F)
The readability of the display may be impaired at temperatures outside the temperature range.

Operating elements

- Operation with 3 push buttons with open housing: ⊕, ⊖, ⊞
or
- External operation via touch control (3 optical keys) without opening the housing: ⊕, ⊖, ⊞
- Operating elements also accessible in various hazardous areas

Additional functionality

- Data backup function
The device configuration can be saved in the display module.
- Data comparison function
The device configuration saved in the display module can be compared to the current device configuration.
- Data transfer function
The transmitter configuration can be transmitted to another device using the display module.

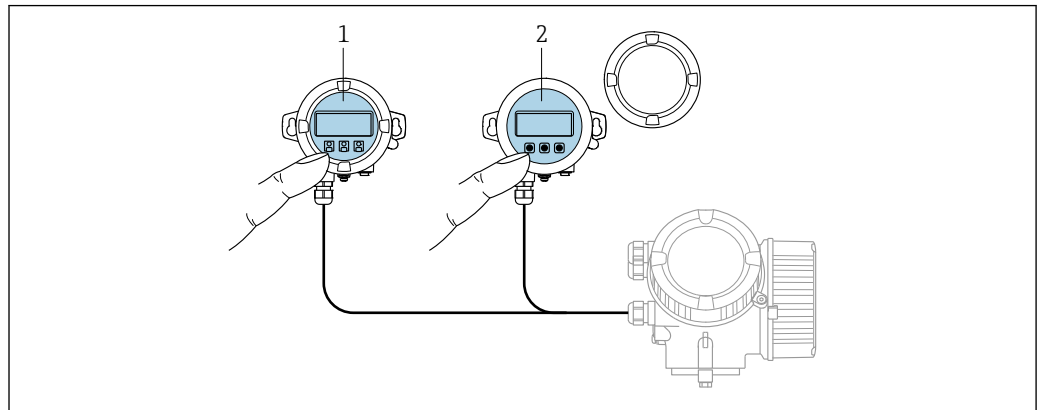
Via remote display and operating module FHX50

A0032215

23 *FHX50 operating options*

- 1 *SD02 display and operating module, push buttons: cover must be opened for operation*
- 2 *SD03 display and operating module, optical buttons: operation possible through cover glass*

Remote operation**Via HART protocol**

This communication interface is available in device versions with a HART output.

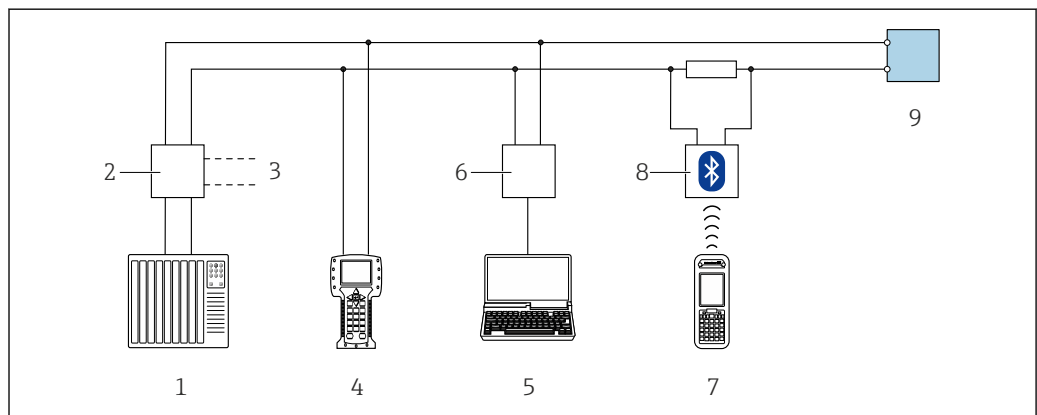

A0028746

24 *Options for remote operation via HART protocol (passive)*

- 1 *Control system (e.g. PLC)*
- 2 *Transmitter power supply unit, e.g. RN221N (with communication resistor)*
- 3 *Connection for Commubox FXA195 and Field Communicator 475*
- 4 *Field Communicator 475*
- 5 *Computer with Web browser (e.g. Internet Explorer) for accessing the integrated device Web server or computer with operating tool (e.g. FieldCare, DeviceCare, AMS Device Manager, SIMATIC PDM) with COM DTM "CDI Communication TCP/IP"*
- 6 *Commubox FXA195 (USB)*
- 7 *Field Xpert SFX350 or SFX370*
- 8 *VIA TOR Bluetooth modem with connecting cable*
- 9 *Transmitter*

Via PROFIBUS PA network

This communication interface is available in device versions with PROFIBUS PA.

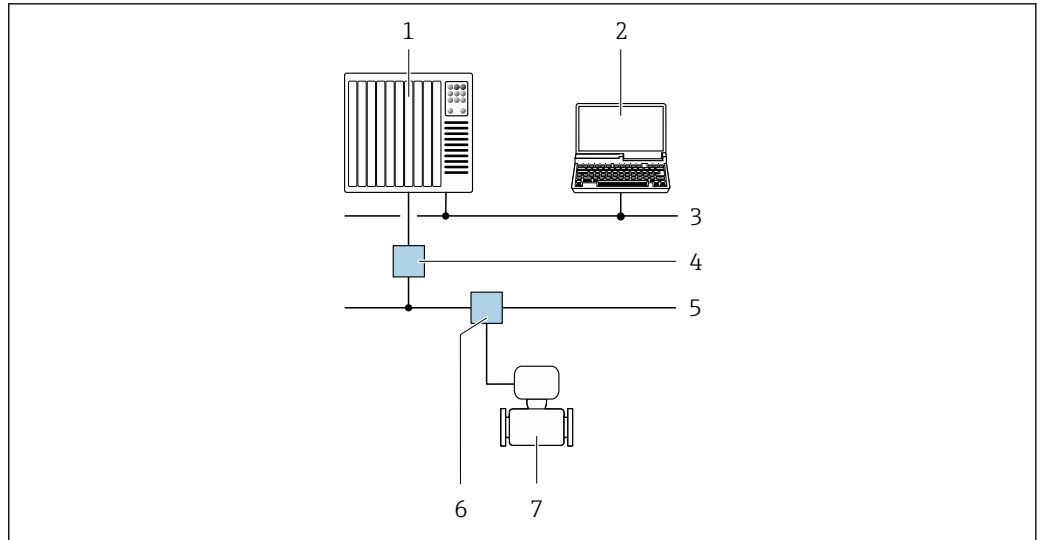

A0028838

25 Options for remote operation via PROFIBUS PA network

- 1 Automation system
- 2 Computer with PROFIBUS network card
- 3 PROFIBUS DP network
- 4 Segment coupler PROFIBUS DP/PA
- 5 PROFIBUS PA network
- 6 T-box
- 7 Measuring device

Via FOUNDATION Fieldbus network

This communication interface is available in device versions with FOUNDATION Fieldbus.

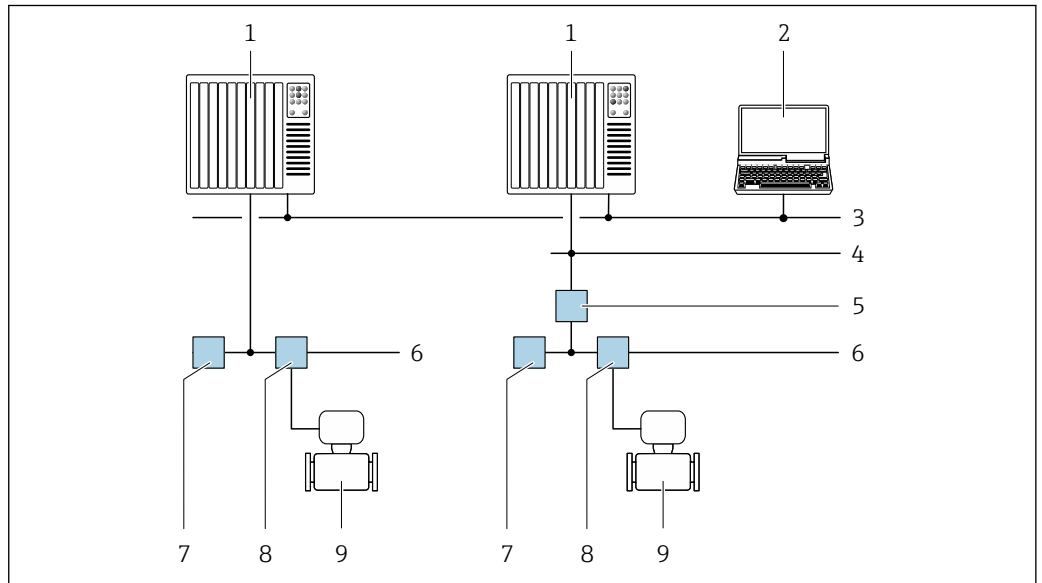

A0028837

26 Options for remote operation via FOUNDATION Fieldbus network

- 1 Automation system
- 2 Computer with FOUNDATION Fieldbus network card
- 3 Industry network
- 4 High Speed Ethernet FF-HSE network
- 5 Segment coupler FF-HSE/FF-H1
- 6 FOUNDATION Fieldbus FF-H1 network
- 7 Power supply FF-H1 network
- 8 T-box
- 9 Measuring device

Service interface

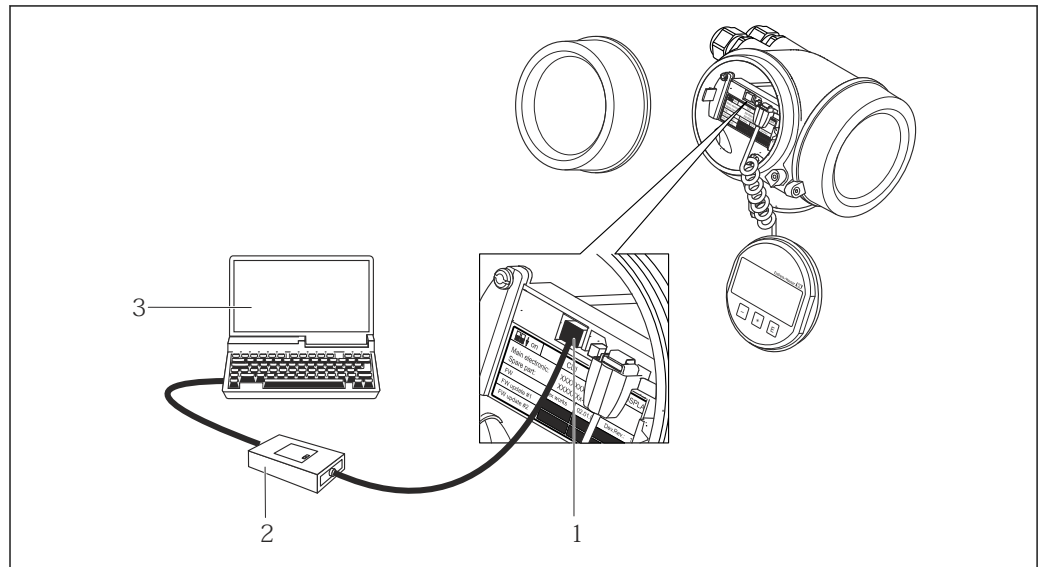

Via service interface (CDI)



A0014019

- 1 Service interface (CDI = Endress+Hauser Common Data Interface) of the measuring device
- 2 Commubox FXA291
- 3 Computer with "FieldCare" operating tool with COM DTM "CDI Communication FXA291"

Certificates and approvals

CE mark	<p>The measuring system is in conformity with the statutory requirements of the applicable EU Directives. These are listed in the corresponding EU Declaration of Conformity along with the standards applied.</p> <p>Endress+Hauser confirms successful testing of the device by affixing to it the CE mark.</p>
C-Tick symbol	<p>The measuring system meets the EMC requirements of the "Australian Communications and Media Authority (ACMA)".</p>
Functional safety	<p>The measuring device can be used for flow monitoring systems (min., max., range) up to SIL 2 (single-channel architecture; order code for "Additional approval", option LA) and SIL 3 (multichannel architecture with homogeneous redundancy) and is independently evaluated and certified by the TÜV in accordance with IEC 61508.</p> <p>The following types of monitoring in safety equipment are possible:</p> <ul style="list-style-type: none"> ■ Mass flow ■ Volume flow ■ Density <p> Functional Safety Manual with information on the SIL device →  69</p>
Ex approval	<p>The measuring device is certified for use in hazardous areas and the relevant safety instructions are provided in the separate "Safety Instructions" (XA) document. Reference is made to this document on the nameplate.</p> <p> The separate Ex documentation (XA) containing all the relevant explosion protection data is available from your Endress+Hauser sales center.</p> <p>ATEX/IECEX</p> <p>Currently, the following versions for use in hazardous areas are available:</p>

Ex d

Category (ATEX)	Type of protection
II2G	Ex d[ia] IIC T6...T1 Gb
II1/2G	Ex d[ia] IIC T6...T1 Ga/Gb
II1/2G, II2D	Ex d[ia] IIC T6...T1 Ga/Gb Ex tb IIIC Txx °C Db

Ex ia

Category (ATEX)	Type of protection
II2G	Ex ia IIC T6...T1 Gb
II1/2G	Ex ia IIC T6...T1 Ga/Gb
II1/2G, II2D	Ex ia IIC T6...T1 Ga/Gb Ex tb IIIC Txx °C Db

Ex nA

Category (ATEX)	Type of protection
II3G	Ex nA IIC T6...T1 Gc

Ex ic

Category (ATEX)	Type of protection
II3G	Ex ic IIC T6...T1 Gc
II1/3G	Ex ic[ia] IIC T6...T1 Ga/Gc

cCSA_{US}

Currently, the following versions for use in hazardous areas are available:

IS (Ex i) and XP (Ex d)

Class I, II, III Division 1 Groups ABCDEFG

NI (Ex nA, Ex nL)

- Class I Division 2 Groups ABCD
- Class II, III Division 1 Groups EFG

Sanitary compatibility



- 3-A approval
- EHEDG-tested

Functional safety

The measuring device can be used for flow monitoring systems (min., max., range) up to SIL 2 (single-channel architecture; order code for "Additional approval", option **LA**) and SIL 3 (multichannel architecture with homogeneous redundancy) and is independently evaluated and certified by the TÜV in accordance with IEC 61508.

The following types of monitoring in safety equipment are possible:

- Mass flow
- Volume flow
- Density

 Functional Safety Manual with information on the SIL device →  69

HART certification

HART interface

The measuring device is certified and registered by the FieldComm Group. The measuring system meets all the requirements of the following specifications:

- Certified according to HART 7
- The device can also be operated with certified devices of other manufacturers (interoperability)

FOUNDATION Fieldbus certification**FOUNDATION Fieldbus interface**

The measuring device is certified and registered by the FieldComm Group. The measuring system meets all the requirements of the following specifications:

- Certified in accordance with FOUNDATION Fieldbus H1
- Interoperability Test Kit (ITK), revision version 6.1.1 (certificate available on request)
- Physical Layer Conformance Test
- The device can also be operated with certified devices of other manufacturers (interoperability)

Certification PROFIBUS**PROFIBUS interface**

The measuring device is certified and registered by the PROFIBUS User Organization (PNO). The measuring system meets all the requirements of the following specifications:

- Certified in accordance with PROFIBUS PA Profile 3.02
- The device can also be operated with certified devices of other manufacturers (interoperability)

Pressure Equipment Directive

The devices can be ordered with or without a PED approval. If a device with a PED approval is required, this must be explicitly stated in the order. For devices with nominal diameters less than or equal to DN 25 (1"), this is neither possible nor necessary.

- With the identification PED/G1/x (x = category) on the sensor nameplate, Endress+Hauser confirms conformity with the "Essential Safety Requirements" specified in Appendix I of the Pressure Equipment Directive 2014/68/EC.
- Devices bearing this marking (PED) are suitable for the following types of medium:
 - Media in Group 1 and 2 with a vapor pressure greater than, or smaller and equal to 0.5 bar (7.3 psi)
 - Unstable gases
- Devices not bearing this marking (PED) are designed and manufactured according to good engineering practice. They meet the requirements of Art. 4, Par. 3 of the Pressure Equipment Directive 2014/68/EU. The range of application is indicated in tables 6 to 9 in Annex II of the Pressure Equipment Directive 2014/68/EC.

Other standards and guidelines

- EN 60529
Degrees of protection provided by enclosures (IP code)
- IEC/EN 60068-2-6
Environmental influences: Test procedure - Test Fc: vibrate (sinusoidal).
- IEC/EN 60068-2-31
Environmental influences: Test procedure - Test Ec: shocks due to rough handling, primarily for devices.
- EN 61010-1
Safety requirements for electrical equipment for measurement, control and laboratory use - general requirements
- IEC/EN 61326
Emission in accordance with Class A requirements. Electromagnetic compatibility (EMC requirements).
- IEC 61508
Functional safety of electrical/electronic/programmable electronic safety-related systems
- NAMUR NE 21
Electromagnetic compatibility (EMC) of industrial process and laboratory control equipment
- NAMUR NE 32
Data retention in the event of a power failure in field and control instruments with microprocessors
- NAMUR NE 43
Standardization of the signal level for the breakdown information of digital transmitters with analog output signal.
- NAMUR NE 53
Software of field devices and signal-processing devices with digital electronics
- NAMUR NE 80
The application of the pressure equipment directive to process control devices
- NAMUR NE 105
Specifications for integrating fieldbus devices in engineering tools for field devices

- NAMUR NE 107
Self-monitoring and diagnosis of field devices
- NAMUR NE 131
Requirements for field devices for standard applications
- NAMUR NE 132
Coriolis mass meter

Ordering information

Detailed ordering information is available from the following sources:

- In the Product Configurator on the Endress+Hauser website: www.endress.com -> Click "Corporate" -> Select your country -> Click "Products" -> Select the product using the filters and search field -> Open product page -> The "Configure" button to the right of the product image opens the Product Configurator.
- From your Endress+Hauser Sales Center: www.addresses.endress.com



Product Configurator - the tool for individual product configuration

- Up-to-the-minute configuration data
- Depending on the device: Direct input of measuring point-specific information such as measuring range or operating language
- Automatic verification of exclusion criteria
- Automatic creation of the order code and its breakdown in PDF or Excel output format
- Ability to order directly in the Endress+Hauser Online Shop

Product generation index

Release date	Product root	Documentation
01.06.2010	8E2B	TI01009D
01.12.2016	8E2C	TI01300D



More information is available from your Sales Center or at:

www.service.endress.com → Downloads

Application packages

Many different application packages are available to enhance the functionality of the device. Such packages might be needed to address safety aspects or specific application requirements.

The application packages can be ordered with the device or subsequently from Endress+Hauser. Detailed information on the order code in question is available from your local Endress+Hauser sales center or on the product page of the Endress+Hauser website: www.endress.com.



Detailed information on the application packages:

Special Documentation for the device → 69

Diagnostics functions

Package	Description
Extended HistoROM	<p>Comprises extended functions concerning the event log and the activation of the measured value memory.</p> <p>Event log: Memory volume is extended from 20 message entries (standard version) to up to 100 entries.</p> <p>Data logging (line recorder):</p> <ul style="list-style-type: none"> ■ Memory capacity for up to 1000 measured values is activated. ■ 250 measured values can be output via each of the 4 memory channels. The recording interval can be defined and configured by the user. ■ Measured value logs can be accessed via the local display or operating tool e.g. FieldCare, DeviceCare or Web server.

Heartbeat Technology



Package	Description
Heartbeat Verification	<p>Heartbeat Verification</p> <p>Meets the requirement for traceable verification to DIN ISO 9001:2008 Chapter 7.6 a) "Control of monitoring and measuring equipment".</p> <ul style="list-style-type: none"> ■ Functional testing in the installed state without interrupting the process. ■ Traceable verification results on request, including a report. ■ Simple testing process via local operation or other operating interfaces. ■ Clear measuring point assessment (pass/fail) with high test coverage within the framework of manufacturer specifications. ■ Extension of calibration intervals according to operator's risk assessment.



Accessories

Various accessories, which can be ordered with the device or subsequently from Endress+Hauser, are available for the device. Detailed information on the order code in question is available from your local Endress+Hauser sales center or on the product page of the Endress+Hauser website: www.endress.com.

Device-specific accessories

For the transmitter









Accessories	Description
Promass 200 transmitter	<p>Transmitter for replacement or storage. Use the order code to define the following specifications:</p> <ul style="list-style-type: none"> ■ Approvals ■ Output ■ Display / operation ■ Housing ■ Software <p> For details, see Installation Instructions EA00104D</p>
Remote display FHX50	<p>FHX50 housing for accommodating a display module .</p> <ul style="list-style-type: none"> ■ FHX50 housing suitable for: <ul style="list-style-type: none"> – SD02 display module (push buttons) – SD03 display module (touch control) ■ Housing material: <ul style="list-style-type: none"> – Plastic PBT – Stainless steel CF-3M (316L, 1.4404) ■ Length of connecting cable: up to max. 60 m (196 ft) (cable lengths available for order: 5 m (16 ft), 10 m (32 ft), 20 m (65 ft), 30 m (98 ft)) <p>The measuring device can be ordered with the FHX50 housing and a display module. The following options must be selected in the separate order codes:</p> <ul style="list-style-type: none"> ■ Order code for measuring device, feature 030: Option L or M "Prepared for FHX50 display" ■ Order code for FHX50 housing, feature 050 (device version): Option A "Prepared for FHX50 display" ■ Order code for FHX50 housing, depends on the desired display module in feature 020 (display, operation): <ul style="list-style-type: none"> – Option C: for an SD02 display module (push buttons) – Option E: for an SD03 display module (touch control) <p>The FHX50 housing can also be ordered as a retrofit kit. The measuring device display module is used in the FHX50 housing. The following options must be selected in the order code for the FHX50 housing:</p> <ul style="list-style-type: none"> ■ Feature 050 (measuring device version): option B "Not prepared for FHX50 display" ■ Feature 020 (display, operation): option A "None, existing displayed used" <p> For details, see Special Documentation SD01007F</p> <p>(Order number: FHX50)</p>

Overvoltage protection for 2-wire devices	<p>Ideally, the overvoltage protection module should be ordered directly with the device. See product structure, characteristic 610 "Accessory mounted", option NA "Overvoltage protection". Separate order necessary only if retrofitting.</p> <ul style="list-style-type: none"> ▪ OVP10: For 1-channel devices (characteristic 020, option A): ▪ OVP20: For 2-channel devices (characteristic 020, options B, C, E or G) <p> For details, see Special Documentation SD01090F.</p>
Protective cover	<p>Is used to protect the measuring device from the effects of the weather: e.g. rainwater, excess heating from direct sunlight or extreme cold in winter.</p> <p> For details, see Special Documentation SD00333F</p>



For the sensor

Accessories	Description
Heating jacket	<p>Is used to stabilize the temperature of the fluids in the sensor. Water, water vapor and other non-corrosive liquids are permitted for use as fluids. If using oil as a heating medium, please consult with Endress+Hauser. Heating jackets cannot be used with sensors fitted with a rupture disk.</p>





Communication-specific accessories

Accessories	Description
Commubox FXA195 HART	<p>For intrinsically safe HART communication with FieldCare via the USB interface.</p> <p> For details, see "Technical Information" TI00404F</p>
Commubox FXA291	<p>Connects Endress+Hauser field devices with a CDI interface (= Endress+Hauser Common Data Interface) and the USB port of a computer or laptop.</p> <p> For details, see the "Technical Information" document TI405C/07</p>
HART Loop Converter HMX50	<p>Is used to evaluate and convert dynamic HART process variables to analog current signals or limit values.</p> <p> For details, see "Technical Information" TI00429F and Operating Instructions BA00371F</p>
Wireless HART adapter SWA70	<p>Is used for the wireless connection of field devices. The WirelessHART adapter can be easily integrated into field devices and existing infrastructures, offers data protection and transmission safety and can be operated in parallel with other wireless networks with minimum cabling complexity.</p> <p> For details, see Operating Instructions BA00061S</p>
Fieldgate FXA320	<p>Gateway for the remote monitoring of connected 4 to 20 mA measuring devices via a Web browser.</p> <p> For details, see "Technical Information" TI00025S and Operating Instructions BA00053S</p>
Fieldgate FXA520	<p>Gateway for the remote diagnostics and remote configuration of connected HART measuring devices via a Web browser.</p> <p> For details, see "Technical Information" TI00025S and Operating Instructions BA00051S</p>
Field Xpert SFX350	<p>Field Xpert SFX350 is a mobile computer for commissioning and maintenance. It enables efficient device configuration and diagnostics for HART and FOUNDATION Fieldbus devices in the non-Ex area.</p> <p> For details, see Operating Instructions BA01202S</p>
Field Xpert SFX370	<p>Field Xpert SFX370 is a mobile computer for commissioning and maintenance. It enables efficient device configuration and diagnostics for HART and FOUNDATION Fieldbus devices in the non-Ex area and the Ex area.</p> <p> For details, see Operating Instructions BA01202S</p>

Service-specific accessories

Accessories	Description
Applicator	<p>Software for selecting and sizing Endress+Hauser measuring devices:</p> <ul style="list-style-type: none"> Choice of measuring devices for industrial requirements Calculation of all the necessary data for identifying the optimum flowmeter: e.g. nominal diameter, pressure loss, flow velocity and accuracy. Graphic illustration of the calculation results Determination of the partial order code, administration, documentation and access to all project-related data and parameters over the entire life cycle of a project. <p>Applicator is available:</p> <ul style="list-style-type: none"> Via the Internet: https://wapps.endress.com/applicator As a downloadable DVD for local PC installation.
W@M	<p>W@M Life Cycle Management Improved productivity with information at your fingertips. Data relevant to a plant and its components is generated from the first stages of planning and during the asset's complete life cycle.</p> <p>W@M Life Cycle Management is an open and flexible information platform with online and on-site tools. Instant access for your staff to current, in-depth data shortens your plant's engineering time, speeds up procurement processes and increases plant uptime.</p> <p>Combined with the right services, W@M Life Cycle Management boosts productivity in every phase. For more information, visit www.endress.com/lifecyclemanagement</p>
FieldCare	<p>FDT-based plant asset management tool from Endress+Hauser. It can configure all smart field units in your system and helps you manage them. By using the status information, it is also a simple but effective way of checking their status and condition.</p> <p> For details, see Operating Instructions BA00027S and BA00059S</p>
DeviceCare	<p>Tool for connecting and configuring Endress+Hauser field devices.</p> <p> For details, see Innovation brochure IN01047S</p>

System components

Accessories	Description
Memograph M graphic display recorder	<p>The Memograph M graphic display recorder provides information on all relevant measured variables. Measured values are recorded correctly, limit values are monitored and measuring points analyzed. The data are stored in the 256 MB internal memory and also on a SD card or USB stick.</p> <p> For details, see "Technical Information" TI00133R and Operating Instructions BA00247R</p>
RN22.1N	<p>Active barrier with power supply for safe separation of 4-20 mA standard signal circuits. Offers bidirectional HART transmission.</p> <p> For details, see "Technical Information" TI00073R and Operating Instructions BA00202R</p>
RNS22.1	<p>Supply unit for powering two 2-wire measuring devices solely in the non-Ex area. Bidirectional communication is possible via the HART communication jacks.</p> <p> For details, see "Technical Information" TI00081R and Brief Operating Instructions KA00110R</p>
Cerabar M	<p>The pressure transmitter for measuring the absolute and gauge pressure of gases, steam and liquids. It can be used to read in the operating pressure value.</p> <p> For details, see "Technical Information" TI00426P, TI00436P and Operating Instructions BA00200P, BA00382P</p>
Cerabar S	<p>The pressure transmitter for measuring the absolute and gauge pressure of gases, steam and liquids. It can be used to read in the operating pressure value.</p> <p> For details, see "Technical Information" TI00383P and Operating Instructions BA00271P</p>

Documentation



For an overview of the scope of the associated Technical Documentation, refer to the following:

- The *W@M Device Viewer* : Enter the serial number from the nameplate (www.endress.com/deviceviewer)
- The *Endress+Hauser Operations App*: Enter the serial number from the nameplate or scan the 2-D matrix code (QR code) on the nameplate.

Standard documentation

Brief Operating Instructions

Part 1 of 2: Sensor

Measuring device	Documentation code
Proline Promass E	KA01261D

Part 2 of 2: Transmitter

Measuring device	Documentation code		
	HART	FOUNDATION Fieldbus	PROFIBUS PA
Proline Promass 200	KA012268	KA01267D	KA01269D

Operating Instructions

Measuring device	Documentation code		
	HART	FOUNDATION Fieldbus	PROFIBUS PA
Proline Promass E 200	BA01638D	BA01639D	BA01637D

Description of device parameters

Measuring device	Documentation code		
	HART	FOUNDATION Fieldbus	PROFIBUS PA
Proline Promass 200	GP01010D	GP01030D	GP01029D

Supplementary device-dependent documentation

Safety instructions

Content	Documentation code
ATEX/IECEX Ex i	XA00144D
ATEX/IECEX Ex d	XA00143D
ATEX/IECEX Ex nA	XA00145D
cCSAus IS	XA00151D
cCSAus XP	XA00152D
INMETRO Ex i	XA01300D
INMETRO Ex d	XA01305D
INMETRO Ex nA	XA01306D
NEPSI Ex i	XA00156D
NEPSI Ex d	XA00155D
NEPSI Ex nA	XA00157D

Special Documentation

Content	Documentation code
Information on the Pressure Equipment Directive	SD01614D
Functional Safety Manual	SD00147D
Display and operating module FHX50	SD01007F

Content	Documentation		
	HART	FOUNDATION Fieldbus	PROFIBUS PA
Heartbeat Technology	SD01849D	SD01848D	SD01850D

Installation Instructions

Contents	Documentation code
Installation Instructions for spare part sets	Specified for each individual accessory

Registered trademarks**HART®**

Registered trademark of the FieldComm Group, Austin, Texas, USA

PROFIBUS®

Registered trademark of the PROFIBUS User Organization, Karlsruhe, Germany

FOUNDATION™ Fieldbus

Registration-pending trademark of the FieldComm Group, Austin, Texas, USA

TRI-CLAMP®

Registered trademark of Ladish & Co., Inc., Kenosha, USA

Applicator®, FieldCare®, DeviceCare®, Field Xpert™, HistoROM®, Heartbeat Technology™

Registered or registration-pending trademarks of the Endress+Hauser Group

www.addresses.endress.com
