

Technical Information

Proline Prowirl F 200

Vortex flowmeter



Versatile flowmeter with wet steam detection and first-rate accuracy

Application

- Preferred measuring principle for wet/saturated/ superheated steam, gases & liquids (also cryogenic)
- Suitable for a wide range of applications; optimized for steam applications

Device properties

- Wet steam capabilities for DN 25 to 300 (1 bis 12")
- Flexible positioning of pressure cell
- Industrial siphon design for pressure measurement
- Display module with data transfer function
- Robust dual-compartment housing
- Plant safety: worldwide approvals (SIL, Haz. area)

Your benefits

- Easy energy management – integrated temperature and pressure measurement for steam and gases
- Space-saving engineering – inlet run compensation
- Same accuracy down to Re 10 000 – most linear Vortex meter body
- Long-term stability – robust drift-free capacitive sensor
- Convenient device wiring – separate connection compartment
- Safe operation – no need to open the device due to display with touch control, background lighting
- Integrated verification – Heartbeat Technology

Table of contents





About this document	4	Shock resistance	52
Symbols used	4	Impact resistance	52
		Electromagnetic compatibility (EMC)	52
Function and system design	5	Process	52
Measuring principle	5	Medium temperature range	52
Measuring system	9	Pressure-temperature ratings	53
		Nominal pressure of sensor	56
Input	10	Pressure specifications	56
Measured variable	10	Pressure loss	57
Measuring range	11	Thermal insulation	57
Operable flow range	16		
Input signal	16	Mechanical construction	58
		Dimensions in SI units	58
Output	17	Dimensions in US units	70
Output signal	17	Weight	77
Signal on alarm	19	Materials	81
Load	20	Flange connections	85
Ex connection data	21		
Low flow cut off	25	Operability	85
Galvanic isolation	26	Operating concept	85
Protocol-specific data	26	Languages	85
		Local operation	86
Power supply	27	Remote operation	87
Terminal assignment	27	Service interface	89
Pin assignment, device plug	30		
Supply voltage	30	Certificates and approvals	89
Power consumption	31	CE mark	89
Current consumption	31	C-Tick symbol	89
Power supply failure	32	Ex approval	89
Electrical connection	32	Functional safety	91
Potential equalization	37	HART certification	92
Terminals	37	FOUNDATION Fieldbus certification	92
Cable entries	37	Certification PROFIBUS	92
Cable specification	37	Pressure Equipment Directive	92
Overvoltage protection	39	Experience	92
		Other standards and guidelines	92
Performance characteristics	40		
Reference operating conditions	40	Ordering information	93
Maximum measured error	40	Product generation index	93
Repeatability	43		
Response time	44	Application packages	93
Influence of ambient temperature	44	Diagnostics functions	93
		Heartbeat Technology	94
Installation	44	Wet steam detection	94
Mounting location	44	Wet steam measurement	94
Orientation	44		
Inlet and outlet runs	46	Accessories	94
Length of connecting cable	48	Device-specific accessories	95
Mounting the transmitter housing	49	Communication-specific accessories	96
Special mounting instructions	49	Service-specific accessories	97
		System components	97
Environment	50		
Ambient temperature range	50	Supplementary documentation	97
Storage temperature	51	Standard documentation	98
Climate class	51	Supplementary device-dependent documentation	98
Degree of protection	51		
Vibration resistance	51		

Registered trademarks 99

About this document

Symbols used









Electrical symbols

Symbol	Meaning
	Direct current
	Alternating current
	Direct current and alternating current
	Ground connection A grounded terminal which, as far as the operator is concerned, is grounded via a grounding system.
	Protective Earth (PE) A terminal which must be connected to ground prior to establishing any other connections. The ground terminals are situated inside and outside the device: <ul style="list-style-type: none"> ▪ Inner ground terminal: Connects the protective earth to the mains supply. ▪ Outer ground terminal: Connects the device to the plant grounding system.

Communication symbols



Symbol	Meaning
	Wireless Local Area Network (WLAN) Communication via a wireless, local network.

Symbols for certain types of information

Symbol	Meaning
	Permitted Procedures, processes or actions that are permitted.
	Preferred Procedures, processes or actions that are preferred.
	Forbidden Procedures, processes or actions that are forbidden.
	Tip Indicates additional information.
	Reference to documentation.
	Reference to page.
	Reference to graphic.
	Visual inspection.

Symbols in graphics

Symbol	Meaning
1, 2, 3, ...	Item numbers
1 , 2 , 3 , ...	Series of steps
A, B, C, ...	Views
A-A, B-B, C-C, ...	Sections

Symbol	Meaning
	Hazardous area
	Safe area (non-hazardous area)
	Flow direction

Function and system design

Measuring principle

Vortex meters work on the principle of the *Karman vortex street*. When fluid flows past a bluff body, vortices are alternately formed on both sides with opposite directions of rotation. These vortices each generate a local low pressure. The pressure fluctuations are recorded by the sensor and converted to electrical pulses. The vortices develop very regularly within the permitted application limits of the device. Therefore, the frequency of vortex shedding is proportional to the volume flow.

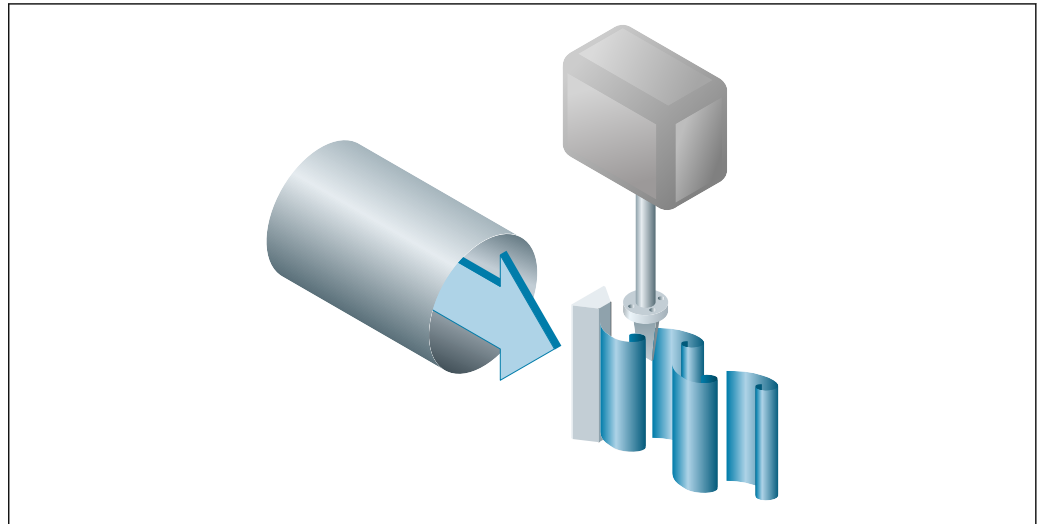

A0033465

 1 Sample graphic

The calibration factor (K-factor) is used as the proportional constant:

$$\text{K-Factor} = \frac{\text{Pulses}}{\text{Unit Volume [m}^3\text{]}}$$

A0003939-EN

Within the application limits of the device, the K-factor only depends on the geometry of the device. It is for $Re > 10\,000$:

- Independent of the flow velocity and the fluid properties viscosity and density
- Independent of the type of substance under measurement: steam, gas or liquid

The primary measuring signal is linear to the flow. After production, the K-factor is determined in the factory by means of calibration. It is not subject to long-time drift or zero-point drift.

The device does not contain any moving parts and does not require any maintenance.

The capacitance sensor

The sensor of a vortex flowmeter has a major influence on the performance, robustness and reliability of the entire measuring system.

The robust DSC sensor is:

- burst-tested
- tested against vibrations
- tested against thermal shock (thermal shocks of 150 K/s)

The measuring device uses the tried-and-tested, capacitance measuring technology from Endress+Hauser, which is already in use in over 450 000 measuring points worldwide. Thanks to its design, the capacitance sensor is also particularly mechanically resistant to temperature shocks and pressure shocks in steam pipelines.

Temperature measurement

The "mass" option is available under the order code for "Sensor version". With this option the measuring device can also measure the temperature of the medium.

The temperature is measured via Pt 1000 temperature sensors. These are located in the paddle of the DSC sensor and are therefore in the direct vicinity of the fluid.

Order code for "Sensor version; DSC sensor; measuring tube":

- Option AA "volume; 316L; 316L"
- Option AB "volume; Alloy C22; 316L"
- Option AC "volume; Alloy C22; Alloy C22"
- Option BA "volume high-temperature; 316L; 316L"
- Option BB "volume high-temperature; Alloy C22; 316L"
- Option CA "Mass; 316L; 316L (integrated temperature measurement)"
- Option CB "Mass; Alloy C22; 316L (integrated temperature measurement)"
- Option CC "Mass; Alloy C22; Alloy C22 (integrated temperature measurement)"

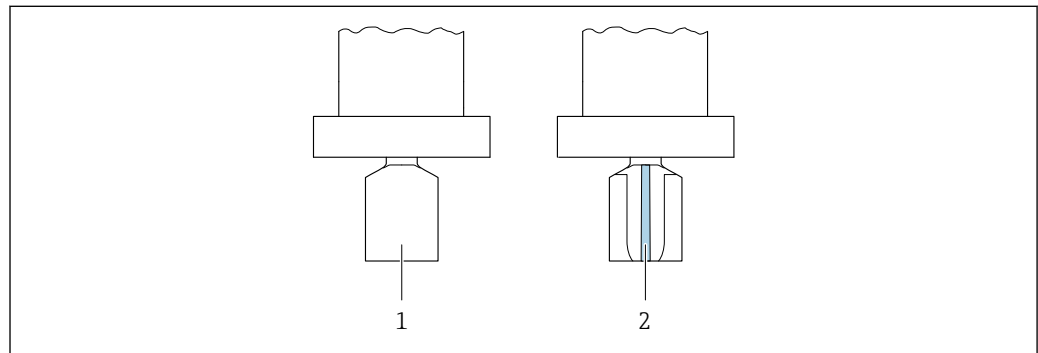

- 1 Order code for "Sensor version", option "volume" or "volume high-temperature"
 2 Order code for "Sensor version", option "mass"

Pressure and temperature measurement

 The "mass" sensor version (integrated pressure/temperature measurement) is available only for measuring devices in the HART communication mode.

The "mass steam" or "mass gas/liquid" options are available under the order code for "Sensor version; DSC sensor; measuring tube". With these options, the measuring device can also measure the pressure and temperature of the fluid.

The temperature is measured via Pt 1000 temperature sensors. These are located in the paddle of the DSC sensor and are therefore in the direct vicinity of the fluid. Pressure measurement is located directly on the meter body at the level of the bluff body. The position of the pressure tapping was chosen so that pressure and temperature could be measured at the same point. This enables accurate density and/or energy compensation of the fluid using pressure and temperature. The measured pressure tends to be somewhat lower than the line pressure. For this reason, Endress+Hauser offers a correction to the line pressure (integrated in the device).

Order code for "Sensor version; DSC sensor; measuring tube":

- Option DA "Mass steam; 316L; 316L (integrated pressure/temperature measurement)"
- Option DB "Mass gas/liquid; 316L; 316L (integrated pressure/temperature measurement)"

Lifelong calibration

Experience has shown that recalibrated measuring devices demonstrate a very high degree of stability compared to their original calibration: The recalibration values were all within the original

measuring accuracy specifications of the devices. This applies to the measured volume flow, the device's primary measured variable.

Various tests and simulation have shown that once the radii of the edges on the bluff body are less than 1 mm (0.04 in), the resulting effect does not have a negative impact on accuracy.

If the radii of the edges on the bluff body do not exceed 1 mm (0.04 in), the following general statements apply (in the case of non-abrasive and non-corrosive media, such as in most water and steam applications):

- The measuring device does not display an offset in the calibration and the accuracy is still guaranteed.
- All the edges on the bluff body have a radius that is typically smaller in size. As the measuring devices are naturally also calibrated with these radii, the measuring device remains within the specified accuracy rating provided that the additional radius that is produced as a result of wear and tear does not exceed 1 mm (0.04 in).

Consequently, it can be said that the product line offers lifelong calibration if the measuring device is used in non-abrasive and non-corrosive media.

Inlet run correction

Inlet run correction makes it possible to shorten the necessary inlet run before the measuring device to a minimum length of $10 \times DN$. If the inlet run available is too short, the measuring device can correct the measured error depending on the preceding disruption in the flow profile. This results in an additional measured error of $\pm 0.5 \%o.r.$ ¹⁾

The **Inlet Run Correction** function can be used for the following pressure ratings and nominal diameters:

DN 15 to 150 (1 to 6")

- EN (DIN)
- ASME B16.5, Sch. 40/80

Inlet run correction is possible for the following flow obstructions:

- Single elbow (90° elbow)
- Double elbow (2 × 90° elbows, opposite)
- Double elbow 3D (2 × 90° elbows, opposite, not on one plane)
- Reduction by one nominal diameter size



Inlet and outlet runs to be considered → 46



For detailed information about inlet run correction, see the Special Documentation for the device

Air and industrial gases

The measuring device enables users to calculate the density and energy of air and industrial gases. The calculations are based on time-tested standard calculation methods. It is possible to automatically compensate for the effect of pressure and temperature via an external or constant value.

This makes it possible to output the energy flow, standard volume flow and mass flow of the following gases:

- Single gas
- Gas mixture
- Air
- User-specific gas



For detailed information on the parameters, see the Operating Instructions. → 98

Natural gas

The device enables users to calculate the chemical properties (gross calorific value, net calorific value) of natural gases. The calculations are based on time-tested standard calculation methods. It is possible to automatically compensate for the effect of pressure and temperature via an external or constant value.

This makes it possible to output the energy flow, standard volume flow and mass flow in accordance with the following standard methods:

1) = of reading

Energy can be calculated based on the following standards:

- AGA5
- ISO 6976
- GPA 2172

Density can be calculated based on the following standards:

- ISO 12213-2 (AGA8-DC92)
- ISO 12213-3
- AGA NX19
- AGA8 Gross 1
- SGERG 88



For detailed information on the parameters, see the Operating Instructions. →  98

Measuring system

The device consists of a transmitter and a sensor.

Two device versions are available:

- Compact version – transmitter and sensor form a mechanical unit.
- Remote version - transmitter and sensor are mounted in separate locations.

Transmitter

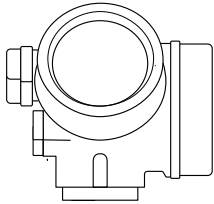
<p>Prowirl 200</p>  <p style="text-align: right; font-size: small;">A0013471</p>	<p>Device versions and materials:</p> <ul style="list-style-type: none"> ■ Compact or remote version, aluminum coated: Aluminum, AlSi10Mg, coated ■ Compact or remote version, stainless: For maximum corrosion resistance: stainless steel, CF3M <p>Configuration:</p> <ul style="list-style-type: none"> ■ Via four-line local display with key operation or via four-line, illuminated local display with touch control and guided menus ("Make-it-run" wizards) for applications ■ Via operating tools (e.g. FieldCare)
--	---

Sensor

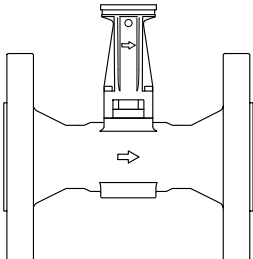
<p>ProwirlF</p>  <p style="text-align: right; font-size: small;">A0034075</p>	<p>Flanged version:</p> <ul style="list-style-type: none"> ■ Nominal diameter range: DN 15 to 300 (½ to 12") ■ Materials: <ul style="list-style-type: none"> - Measuring tubes DN 15 to 300 (½ to 12"): stainless cast steel, CF3M/1.4408 DN 15 to 150 (½ to 6"): cast, CX2MW similar to Alloy C22/2.4602 - Flange connections DN 15 to 300 (½ to 12"): stainless steel, triple-certified material, 1.4404/F316/F316L DN 15 to 150 (½ to 6"), pressure ratings up to PN40/Class 300: cast, CX2MW similar to Alloy C22/2.4602
--	---

Pressure measuring cell

 The "mass" sensor version (integrated pressure/temperature measurement) is available only for measuring devices in the HART communication mode.

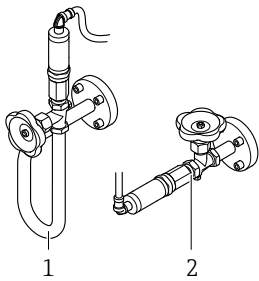
 <p style="text-align: right; font-size: small;">A0034080</p> <p>1 Option DA "mass steam" 2 Option DB "mass gas/liquid"</p>	<p>Versions:</p> <p>Pressure components</p> <ul style="list-style-type: none"> - Pressure measuring cell 2 bar_a - Pressure measuring cell 4 bar_a - Pressure measuring cell 10 bar_a - Pressure measuring cell 40 bar_a - Pressure measuring cell 100 bar_a <p>Material</p> <ul style="list-style-type: none"> ■ Wetted parts: <ul style="list-style-type: none"> - Process connection Stainless steel, 1.4404/316L - Membrane Stainless steel, 1.4435/316L ■ Non-wetted parts: Housing Stainless steel, 1.4404
--	--

Input

Measured variable

Direct measured variables

Order code for "Sensor version; DSC sensor; measuring tube"		
Option	Description	Measured variable
AA	Volume; 316L; 316L	Volume flow
AB	Volume; Alloy C22; 316L	
AC	Volume; Alloy C22; Alloy C22	
BA	Volume high-temperature; 316L; 316L	
BB	Volume high-temperature; Alloy C22; 316L	

Order code for "Sensor version; DSC sensor; measuring tube"		
Option	Description	Measured variable
CA	Mass; 316L; 316L (integrated temperature measurement)	<ul style="list-style-type: none"> ▪ Volume flow ▪ Temperature
CB	Mass; Alloy ; C22; 316L (integrated temperature measurement)	
CC	Mass; Alloy C22; Alloy C22 (integrated temperature measurement)	

 The "mass" sensor version (integrated pressure/temperature measurement) is available only for measuring devices in the HART communication mode.

Order code for "Sensor version; DSC sensor; measuring tube"		
Option	Description	Measured variable
DA	Mass steam; 316L; 316L (integrated pressure/temperature measurement)	<ul style="list-style-type: none"> ▪ Volume flow ▪ Temperature ▪ Pressure
DB	Mass gas/liquid; 316L; 316L (integrated pressure/temperature measurement),	

Calculated measured variables

Order code for "Sensor version; DSC sensor; measuring tube"		
Option	Description	Measured variable
AA	Volume; 316L; 316L	Under constant process conditions: <ul style="list-style-type: none"> ▪ Mass flow ¹⁾ ▪ Corrected volume flow
AB	Volume; Alloy C22; 316L	
AC	Volume; Alloy C22; Alloy C22	The totalized values for: <ul style="list-style-type: none"> ▪ Volume flow ▪ Mass flow ▪ Corrected volume flow
BA	Volume high-temperature; 316L; 316L	
BB	Volume high-temperature; Alloy C22; 316L	

1) A fixed density must be entered for calculating the mass flow (**Setup** menu → **Advanced setup** submenu → **External compensation** submenu → **Fixed density** parameter).

Order code for "Sensor version; DSC sensor; measuring tube"		
Option	Description	Measured variable
CA	Mass; 316L; 316L (integrated temperature measurement)	<ul style="list-style-type: none"> ▪ Corrected volume flow ▪ Mass flow ▪ Calculated saturated steam pressure ▪ Energy flow ▪ Heat flow difference ▪ Specific volume ▪ Degrees of superheat
CB	Mass; Alloy C22; 316L (integrated temperature measurement)	
CC	Mass; Alloy C22; Alloy C22 (integrated temperature measurement)	

Order code for "Sensor version; DSC sensor; measuring tube"		
Option	Description	Measured variable
DA	Mass steam; 316L; 316L (integrated pressure/temperature measurement)	
DB	Mass gas/liquid; 316L; 316L (integrated pressure/temperature measurement)	

Order code for "Sensor version", option "mass flow (integrated temperature measurement)" combined with order code for "Application package"		
Option	Description	Measured variable
EU	Wet steam measurement	<ul style="list-style-type: none"> ■ Steam quality ■ Total mass flow ■ Condensate mass flow

Measuring range

The measuring range is dependent on the nominal diameter, the fluid and environmental influences.

 The following specified values are the largest possible flow measuring ranges (Q_{min} to Q_{max}) for each nominal diameter. Depending on the fluid properties and environmental influences, the measuring range may be subject to additional restrictions. Additional restrictions apply to both the lower range value and the upper range value.

Flow measuring ranges in SI units

DN [mm]	Liquids [m ³ /h]	Gas/steam [m ³ /h]
15	0.076 to 4.9	0.39 to 25
25	0.23 to 15	1.2 to 130
40	0.57 to 37	2.9 to 310
50	0.96 to 62	4.9 to 820
80	2.2 to 140	11 to 1800
100	3.7 to 240	19 to 3200
150	8.5 to 540	43 to 7300
200	15 to 950	75 to 13000
250	23 to 1500	120 to 20000
300	33 to 2100	170 to 28000

Flow measuring ranges in US units

DN [in]	Liquids [ft ³ /min]	Gas/steam [ft ³ /min]
½	0.045 to 2.9	0.23 to 15
1	0.14 to 8.8	0.7 to 74
1½	0.34 to 22	1.7 to 180
2	0.56 to 36	2.9 to 480
3	1.3 to 81	6.4 to 1100
4	2.2 to 140	11 to 1900
6	5 to 320	25 to 4300
8	8.7 to 560	44 to 7500
10	14 to 880	70 to 12000
12	19 to 1300	99 to 17000

Flow velocity

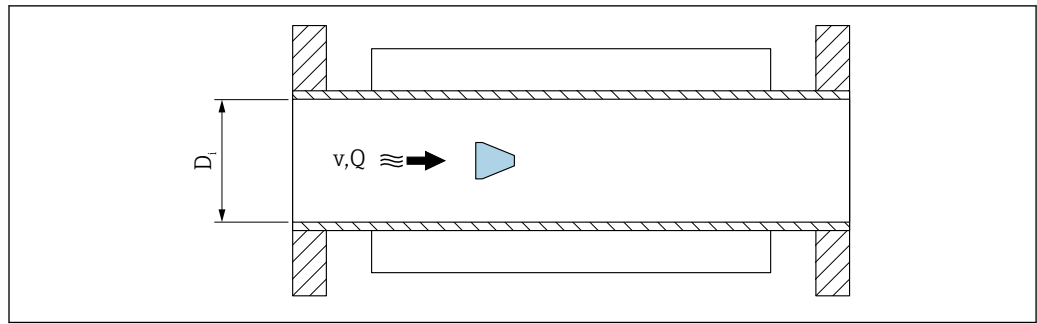

A0033468

D_i Internal diameter of measuring tube (corresponds to dimension $K \rightarrow$ 58)

v Velocity in measuring tube

Q Flow

i The internal diameter of measuring tube D_i is denoted in the dimensions as dimension $K \rightarrow$ 58.

Calculation of flow velocity:

$$v \text{ [m/s]} = \frac{4 \cdot Q \text{ [m}^3\text{/h]}}{\pi \cdot D_i \text{ [m]}^2} \cdot \frac{1}{3600 \text{ [s/h]}}$$

$$v \text{ [ft/s]} = \frac{4 \cdot Q \text{ [ft}^3\text{/min]}}{\pi \cdot D_i \text{ [ft]}^2} \cdot \frac{1}{60 \text{ [s/min]}}$$

A0034301

Lower range value

A restriction applies to the lower range value due to the turbulent flow profile, which increases only in the case of Reynolds 5 000 numbers. The Reynolds number is dimensionless and indicates the ratio of the inertia force of a fluid to its viscous force when flowing and is used as a characteristic variable for pipe flows. In the case of pipe flows with Reynolds numbers less than 5 000, periodic vortices are no longer generated and flow rate measurement is no longer possible.

The Reynolds number is calculated as follows:

$$Re = \frac{4 \cdot Q \text{ [m}^3\text{/s]} \cdot \rho \text{ [kg/m}^3\text{]}}{\pi \cdot D_i \text{ [m]} \cdot \mu \text{ [Pa} \cdot \text{s]}}$$

$$Re = \frac{4 \cdot Q \text{ [ft}^3\text{/s]} \cdot \rho \text{ [lbm/ft}^3\text{]}}{\pi \cdot D_i \text{ [ft]} \cdot \mu \text{ [lbf} \cdot \text{s/ft}^2\text{]}}$$

A0034291

Re Reynolds number

Q Flow

D_i Internal diameter of measuring tube (corresponds to dimension $K \rightarrow$ 58)

μ Dynamic viscosity

ρ Density

The Reynolds number, 5 000 together with the density and viscosity of the fluid and the nominal diameter, is used to calculate the corresponding flow rate.

$$Q_{Re=5000} [\text{m}^3/\text{h}] = \frac{5000 \cdot \pi \cdot D_i [\text{m}] \cdot \mu [\text{Pa} \cdot \text{s}]}{4 \cdot \rho [\text{kg}/\text{m}^3]} \cdot 3600 [\text{s}/\text{h}]$$

$$Q_{Re=5000} [\text{ft}^3/\text{h}] = \frac{5000 \cdot \pi \cdot D_i [\text{ft}] \cdot \mu [\text{lbf} \cdot \text{s}/\text{ft}^2]}{4 \cdot \rho [\text{lbm}/\text{ft}^3]} \cdot 60 [\text{s}/\text{min}]$$

A0034302

$Q_{Re=5000}$ Flow rate is dependent on the Reynolds number

D_i Internal diameter of measuring tube (corresponds to dimension $K \rightarrow$ 58)

μ Dynamic viscosity

ρ Density

The measuring signal must have a certain minimum signal amplitude so that the signals can be evaluated without any errors. Using the nominal diameter, the corresponding flow can also be derived from this amplitude. The minimum signal amplitude depends on the setting for the sensitivity of the DSC sensor (s), the steam quality (x) and the force of the vibrations present (a). The value mf corresponds to the lowest measurable flow velocity without vibration (no wet steam) at a density of $1 \text{ kg}/\text{m}^3$ ($0.0624 \text{ lbm}/\text{ft}^3$). The value mf can be set in the range from 6 to 20 m/s (1.8 to 6 ft/s) (factory setting 12 m/s (3.7 ft/s)) with the **Sensitivity** parameter (value range 1 to 9, factory setting 5).

The value mf can be set in the range from 4.5 to 20 m/s (1.4 to 6 ft/s) for device versions with the order code for "Calibration flow", option N "0.65% volume PremiumCal 5-point, extended turndown". The lowest flow velocity that can be measured on account of the signal amplitude v_{AmpMin} is derived from the **Sensitivity** parameter and the steam quality (x) or from the force of vibrations present (a).

$$v_{\text{AmpMin}} [\text{m}/\text{s}] = \max \left\{ \begin{array}{l} \frac{\text{mf} [\text{m}/\text{s}]}{x^2} \\ \sqrt{50 [\text{m}] \cdot a [\text{m}/\text{s}^2]} \end{array} \right.$$

$$v_{\text{AmpMin}} [\text{ft}/\text{s}] = \max \left\{ \begin{array}{l} \frac{\text{mf} [\text{ft}/\text{s}]}{x^2} \\ \sqrt{164 [\text{ft}] \cdot a [\text{ft}/\text{s}^2]} \end{array} \right.$$

A0034303

v_{AmpMin} Minimum measurable flow velocity based on signal amplitude

mf Sensitivity

x Steam quality

a Vibration

$$Q_{\text{AmpMin}} [\text{m}^3/\text{h}] = \frac{v_{\text{AmpMin}} [\text{m/s}] \cdot \pi \cdot D_i [\text{m}]^2}{4 \cdot \sqrt{\frac{\rho [\text{kg}/\text{m}^3]}{1 [\text{kg}/\text{m}^3]}}} \cdot 3600 [\text{s/h}]$$

$$Q_{\text{AmpMin}} [\text{ft}^3/\text{min}] = \frac{v_{\text{AmpMin}} [\text{ft/s}] \cdot \pi \cdot D_i [\text{ft}]^2}{4 \cdot \sqrt{\frac{\rho [\text{lbm}/\text{ft}^3]}{0.0624 [\text{lbm}/\text{ft}^3]}}} \cdot 60 [\text{s/min}]$$

A0034304

Q_{AmpMin} Minimum measurable flow rate based on signal amplitude

v_{AmpMin} Minimum measurable flow velocity based on signal amplitude

D_i Internal diameter of measuring tube (corresponds to dimension $K \rightarrow$ 58)

ρ Density

The effective lower range value Q_{Low} is determined using the largest of the three values Q_{min} , $Q_{\text{Re} = 5000}$ and Q_{AmpMin} .

$$Q_{\text{Low}} [\text{m}^3/\text{h}] = \max \begin{cases} Q_{\text{min}} [\text{m}^3/\text{h}] \\ Q_{\text{Re} = 5000} [\text{m}^3/\text{h}] \\ Q_{\text{AmpMin}} [\text{m}^3/\text{h}] \end{cases}$$

$$Q_{\text{Low}} [\text{ft}^3/\text{min}] = \max \begin{cases} Q_{\text{min}} [\text{ft}^3/\text{min}] \\ Q_{\text{Re} = 5000} [\text{ft}^3/\text{min}] \\ Q_{\text{AmpMin}} [\text{ft}^3/\text{min}] \end{cases}$$

A0034313

Q_{Low} Effective lower range value

Q_{min} Minimum measurable flow rate

$Q_{\text{Re} = 5000}$ Flow rate is dependent on the Reynolds number

Q_{AmpMin} Minimum measurable flow rate based on signal amplitude



The Applicator is available for calculation purposes.

Upper range value

The measuring signal amplitude must be below a certain limit value to ensure that the signals can be evaluated without error. This results in a maximum permitted flow rate Q_{AmpMax} :

$$Q_{\text{AmpMax}} [\text{m}^3/\text{h}] = \frac{350 [\text{m/s}] \cdot \pi \cdot D_i [\text{m}]^2}{4 \cdot \sqrt{\frac{\rho [\text{kg}/\text{m}^3]}{1 [\text{kg}/\text{m}^3]}}} \cdot 3600 [\text{s/h}]$$

$$Q_{\text{AmpMax}} [\text{ft}^3/\text{min}] = \frac{1148 [\text{ft/s}] \cdot \pi \cdot D_i [\text{ft}]^2}{4 \cdot \sqrt{\frac{\rho [\text{lbm}/\text{ft}^3]}{0.0624 [\text{lbm}/\text{ft}^3]}}} \cdot 60 [\text{s/min}]$$

A0034316

- Q_{AmpMax} Maximum measurable flow rate based on signal amplitude
- D_i Internal diameter of measuring tube (corresponds to dimension $K \rightarrow$ 58)
- ρ Density

For gas applications, an additional restriction applies to the upper range value with regard to the Mach number in the measuring device, which must be less than 0.3. The Mach number Ma describes the ratio of the flow velocity v to the sound velocity c in the fluid.

$$Ma = \frac{v \text{ [m/s]}}{c \text{ [m/s]}}$$

$$Ma = \frac{v \text{ [ft/s]}}{c \text{ [ft/s]}}$$

A0034321

- Ma Mach number
- v Flow velocity
- c Sound velocity

The corresponding flow rate can be derived using the nominal diameter.

$$Q_{Ma=0.3} \text{ [m}^3\text{/h]} = \frac{0.3 \cdot c \text{ [m/s]} \cdot \pi \cdot D_i \text{ [m]}^2}{4} \cdot 3600 \text{ [s/h]}$$

$$Q_{Ma=0.3} \text{ [ft}^3\text{/min]} = \frac{0.3 \cdot c \text{ [ft/s]} \cdot \pi \cdot D_i \text{ [ft]}^2}{4} \cdot 60 \text{ [s/min]}$$

A0034337

- $Q_{Ma=0.3}$ Restricted upper range value is dependent on Mach number
- c Sound velocity
- D_i Internal diameter of measuring tube (corresponds to dimension $K \rightarrow$ 58)
- ρ Density

The effective upper range value Q_{High} is determined using the smallest of the three values Q_{max} , Q_{AmpMax} and $Q_{Ma=0.3}$.

$$Q_{High} \text{ [m}^3\text{/h]} = \min \begin{cases} Q_{max} \text{ [m}^3\text{/h]} \\ Q_{AmpMax} \text{ [m}^3\text{/h]} \\ Q_{Ma=0.3} \text{ [m}^3\text{/h]} \end{cases}$$

$$Q_{High} \text{ [ft}^3\text{/min]} = \min \begin{cases} Q_{max} \text{ [ft}^3\text{/min]} \\ Q_{AmpMax} \text{ [ft}^3\text{/min]} \\ Q_{Ma=0.3} \text{ [ft}^3\text{/min]} \end{cases}$$

A0034338

- Q_{High} Effective upper range value
- Q_{max} Maximum measurable flow rate

Q_{AmpMax} Maximum measurable flow rate based on signal amplitude

$Q_{Ma = 0.3}$ Restricted upper range value is dependent on Mach number

For liquids, the occurrence of cavitation may also restrict the upper range value.

 The Applicator is available for calculation purposes.

Operable flow range

The value, which is typically up to 49: 1, may vary depending on the operating conditions (ratio between upper range value and lower range value)

Input signal

Current input

Current input	4-20 mA (passive)
Resolution	1 μ A
Voltage drop	Typically: 2.2 to 3 V for 3.6 to 22 mA
Maximum voltage	≤ 35 V
Possible input variables	<ul style="list-style-type: none"> ▪ Pressure ▪ Temperature ▪ Density

External measured values

To increase the accuracy of certain measured variables or to calculate the corrected volume flow, the automation system can continuously write different measured values to the measuring device:

- Operating pressure to increase accuracy (Endress+Hauser recommends the use of a pressure measuring device for absolute pressure, e.g. Cerabar M or Cerabar S)
- Medium temperature to increase accuracy (e.g. iTEMP)
- Reference density for calculating the corrected volume flow



- Various pressure measuring devices can be ordered as accessories from Endress+Hauser.
- If using pressure measuring devices, pay attention to outlet runs when installing external devices →  48.

If the measuring device does not have pressure or temperature compensation ²⁾, it is recommended that external pressure measurement values be read in so that the following measured variables can be calculated:

- Energy flow
- Mass flow
- Corrected volume flow

Integrated pressure and temperature measurement

The measuring device can also directly record external variables for density and energy compensation.

This product version offers the following benefits:

- Measurement of pressure, temperature and flow in a true 2-wire version
- Recording of pressure and temperature at the same point, thus ensuring maximum accuracy of density and energy compensation.
- Continuous monitoring of pressure and temperature, thus enabling complete integration in Heartbeat.
- Easy testing of pressure measurement accuracy:
 - Application of pressure by pressure calibration unit, followed by input into measuring device
 - Automatic error correction performed by device in the event of a deviation
- Availability of calculated line pressure.

Current input

The measured values are written from the automation system to the measuring device via the current input →  16.

2) Order code for "Sensor option", option DA, DB

HART protocol

The measured values are written from the automation system to the measuring device via the HART protocol. The pressure transmitter must support the following protocol-specific functions:

- HART protocol
- Burst mode

Digital communication

The measured values can be written from the automation system to the measuring via:

- FOUNDATION Fieldbus
- PROFIBUS PA



Output

Output signal

Current output

Current output 1	4-20 mA HART (passive)
Current output 2	4-20 mA (passive)
Resolution	< 1 µA
Damping	Adjustable: 0.0 to 999.9 s
Assignable measured variables	<ul style="list-style-type: none"> ▪ Volume flow ▪ Corrected volume flow ▪ Mass flow ▪ Flow velocity ▪ Temperature ▪ Pressure ▪ Calculated saturated steam pressure ▪ Steam quality ▪ Total mass flow ▪ Energy flow ▪ Heat flow difference

Pulse/frequency/switch output

Function	Can be set to pulse, frequency or switch output
Version	Passive, open collector
Maximum input values	<ul style="list-style-type: none"> ▪ DC 35 V ▪ 50 mA <p> For information on the Ex connection values →  21</p>
Voltage drop	<ul style="list-style-type: none"> ▪ For ≤ 2 mA: 2 V ▪ For 10 mA: 8 V
Residual current	≤ 0.05 mA
Pulse output	
Pulse width	Adjustable: 5 to 2 000 ms
Maximum pulse rate	100 Impulse/s
Pulse value	Adjustable
Assignable measured variables	<ul style="list-style-type: none"> ▪ Mass flow ▪ Volume flow ▪ Corrected volume flow ▪ Total mass flow ▪ Energy flow ▪ Heat flow difference
Frequency output	

Output frequency	Adjustable: 0 to 1000 Hz
Damping	Adjustable: 0 to 999 s
Pulse/pause ratio	1:1
Assignable measured variables	<ul style="list-style-type: none"> ■ Volume flow ■ Corrected volume flow ■ Mass flow ■ Flow velocity ■ Temperature ■ Calculated saturated steam pressure ■ Steam quality ■ Total mass flow ■ Energy flow ■ Heat flow difference ■ Pressure
Switch output	
Switching behavior	Binary, conductive or non-conductive
Switching delay	Adjustable: 0 to 100 s
Number of switching cycles	Unlimited
Assignable functions	<ul style="list-style-type: none"> ■ Off ■ On ■ Diagnostic behavior ■ Limit value <ul style="list-style-type: none"> - Volume flow - Corrected volume flow - Mass flow - Flow velocity - Temperature - Calculated saturated steam pressure - Steam quality - Total mass flow - Energy flow - Heat flow difference - Pressure - Reynolds number - Totalizer 1-3 ■ Status ■ Status of low flow cut off

FOUNDATION Fieldbus

FOUNDATION Fieldbus	H1, IEC 61158-2, galvanically isolated
Data transfer	31.25 kbit/s
Current consumption	15 mA
Permitted supply voltage	9 to 32 V
Bus connection	With integrated reverse polarity protection

PROFIBUS PA

PROFIBUS PA	In accordance with EN 50170 Volume 2, IEC 61158-2 (MBP), galvanically isolated
Data transfer	31.25 kbit/s
Current consumption	10 mA
Permitted supply voltage	9 to 32 V
Bus connection	With integrated reverse polarity protection

Signal on alarm

Depending on the interface, failure information is displayed as follows:

Current output 4 to 20 mA

4 to 20 mA

Failure mode	Choose from: <ul style="list-style-type: none"> ▪ 4 to 20 mA in accordance with NAMUR recommendation NE 43 ▪ 4 to 20 mA in accordance with US ▪ Min. value: 3.59 mA ▪ Max. value: 22.5 mA ▪ Freely definable value between: 3.59 to 22.5 mA ▪ Actual value ▪ Last valid value
---------------------	--

Pulse/frequency/switch output

Pulse output	
Failure mode	No pulses
Frequency output	
Failure mode	Choose from: <ul style="list-style-type: none"> ▪ Actual value ▪ 0 Hz ▪ Defined value: 0 to 1 250 Hz
Switch output	
Failure mode	Choose from: <ul style="list-style-type: none"> ▪ Current status ▪ Open ▪ Closed

FOUNDATION Fieldbus

Status and alarm messages	Diagnostics in accordance with FF-89 1
Error current FDE (Fault Disconnection Electronic)	0 mA

PROFIBUS PA

Status and alarm messages	Diagnostics in accordance with PROFIBUS PA Profile 3.02
Error current FDE (Fault Disconnection Electronic)	0 mA

Local display

Plain text display	With information on cause and remedial measures
Backlight	Additionally for device version with SD03 local display: red lighting indicates a device error.

 Status signal as per NAMUR recommendation NE 107

Interface/protocol

- Via digital communication:
 - HART protocol
 - FOUNDATION Fieldbus
 - PROFIBUS PA
- Via service interface
 - CDI service interface

Plain text display	With information on cause and remedial measures
---------------------------	---



Additional information on remote operation → 87

Load

Load for current output: 0 to 500 Ω, depending on the external supply voltage of the power supply unit

Calculation of the maximum load

Depending on the supply voltage of the power supply unit (U_S), the maximum load (R_B) including line resistance must be observed to ensure adequate terminal voltage at the device. In doing so, observe the minimum terminal voltage

- $R_B \leq (U_S - U_{\text{term. min}}) : 0.022 \text{ A}$
- $R_B \leq 500 \Omega$

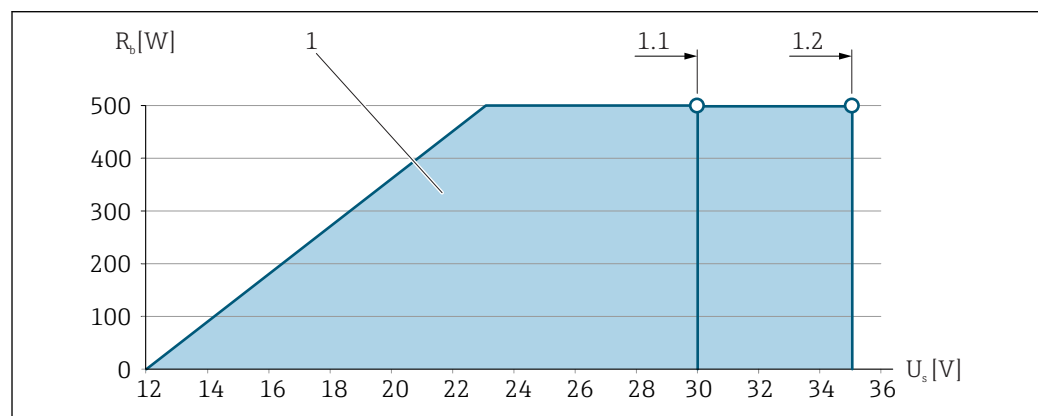

2 Load for a compact version without local operation

1 Operating range

- 1.1 For order code for "Output", option A "4-20 mA HART"/option B "4-20 mA HART, pulse/frequency/switch output" with Ex i and option C "4-20 mA HART + 4-20 mA analog"
- 1.2 For order code for "Output", option A "4-20 mA HART"/option B "4-20 mA HART, pulse/frequency/switch output" for non-hazardous area and Ex d

Sample calculation

Supply voltage of power supply unit:

- $U_S = 19 \text{ V}$
- $U_{\text{term. min}} = 12 \text{ V}$ (measuring device) + 1 V (local operation without lighting) = 13 V

Maximum load: $R_B \leq (19 \text{ V} - 13 \text{ V}) : 0.022 \text{ A} = 273 \Omega$



The minimum terminal voltage ($U_{Kl \text{ min}}$) increases if local operation is used..

Ex connection data**Safety-related values***Type of protection Ex d*

Order code for "Output"	Output type	Safety-related values
Option A	4-20mA HART	$U_{nom} = DC 35 V$ $U_{max} = 250 V$
Option B	4-20mA HART	$U_{nom} = DC 35 V$ $U_{max} = 250 V$
	Pulse/frequency/switch output	$U_{nom} = DC 35 V$ $U_{max} = 250 V$ $P_{max} = 1 W^{1)}$
Option C	4-20mA HART	$U_{nom} = DC 30 V$ $U_{max} = 250 V$
	4-20mA analog	
Option D	4-20mA HART	$U_{nom} = DC 35 V$ $U_{max} = 250 V$
	Pulse/frequency/switch output	$U_{nom} = DC 35 V$ $U_{max} = 250 V$ $P_{max} = 1 W^{1)}$
	4 to 20 mA current input	$U_{nom} = DC 35 V$ $U_{max} = 250 V$
Option E	FOUNDATION Fieldbus	$U_{nom} = DC 32 V$ $U_{max} = 250 V$ $P_{max} = 0.88 W$
	Pulse/frequency/switch output	$U_{nom} = DC 35 V$ $U_{max} = 250 V$ $P_{max} = 1 W^{1)}$
Option G	PROFIBUS PA	$U_{nom} = DC 32 V$ $U_{max} = 250 V$ $P_{max} = 0.88 W$
	Pulse/frequency/switch output	$U_{nom} = DC 35 V$ $U_{max} = 250 V$ $P_{max} = 1 W^{1)}$

1) Internal circuit limited by $R_i = 760.5 \Omega$

Type of protection Ex ec

Order code for "Output"	Output type	Safety-related values
Option A	4-20mA HART	$U_{nom} = DC 35 V$ $U_{max} = 250 V$
Option B	4-20mA HART	$U_{nom} = DC 35 V$ $U_{max} = 250 V$
	Pulse/frequency/switch output	$U_{nom} = DC 35 V$ $U_{max} = 250 V$ $P_{max} = 1 W^{1)}$
Option C	4-20mA HART	$U_{nom} = DC 30 V$ $U_{max} = 250 V$
	4-20mA analog	
Option D	4-20mA HART	$U_{nom} = DC 35 V$ $U_{max} = 250 V$
	Pulse/frequency/switch output	$U_{nom} = DC 35 V$ $U_{max} = 250 V$ $P_{max} = 1 W^{1)}$
	4 to 20 mA current input	$U_{nom} = DC 35 V$ $U_{max} = 250 V$

Order code for "Output"	Output type	Safety-related values
Option E	FOUNDATION Fieldbus	$U_{nom} = DC 32 V$ $U_{max} = 250 V$ $P_{max} = 0.88 W$
	Pulse/frequency/switch output	$U_{nom} = DC 35 V$ $U_{max} = 250 V$ $P_{max} = 1 W^{1)}$
Option G	PROFIBUS PA	$U_{nom} = DC 32 V$ $U_{max} = 250 V$ $P_{max} = 0.88 W$
	Pulse/frequency/switch output	$U_{nom} = DC 35 V$ $U_{max} = 250 V$ $P_{max} = 1 W^{1)}$

1) Internal circuit limited by $R_i = 760.5 \Omega$

Type of protection XP

Order code for "Output"	Output type	Safety-related values
Option A	4-20mA HART	$U_{nom} = DC 35 V$ $U_{max} = 250 V$
Option B	4-20mA HART	$U_{nom} = DC 35 V$ $U_{max} = 250 V$
	Pulse/frequency/switch output	$U_{nom} = DC 35 V$ $U_{max} = 250 V$ $P_{max} = 1 W^{1)}$
Option C	4-20mA HART	$U_{nom} = DC 30 V$ $U_{max} = 250 V$
	4-20mA analog	
Option D	4-20mA HART	$U_{nom} = DC 35 V$ $U_{max} = 250 V$
	Pulse/frequency/switch output	$U_{nom} = DC 35 V$ $U_{max} = 250 V$ $P_{max} = 1 W^{1)}$
	4 to 20 mA current input	$U_{nom} = DC 35 V$ $U_{max} = 250 V$
Option E	FOUNDATION Fieldbus	$U_{nom} = DC 32 V$ $U_{max} = 250 V$ $P_{max} = 0.88 W$
	Pulse/frequency/switch output	$U_{nom} = DC 35 V$ $U_{max} = 250 V$ $P_{max} = 1 W^{1)}$
Option G	PROFIBUS PA	$U_{nom} = DC 32 V$ $U_{max} = 250 V$ $P_{max} = 0.88 W$
	Pulse/frequency/switch output	$U_{nom} = DC 35 V$ $U_{max} = 250 V$ $P_{max} = 1 W^{1)}$

1) Internal circuit limited by $R_i = 760.5 \Omega$

Intrinsically safe values

Type of protection Ex ia

Order code for "Output"	Output type	Intrinsically safe values	
Option A	4-20mA HART	$U_i = DC\ 30\ V$ $I_i = 300\ mA$ $P_i = 1\ W$ $L_i = 0\ \mu H$ $C_i = 5\ nF$	
Option B	4-20mA HART	$U_i = DC\ 30\ V$ $I_i = 300\ mA$ $P_i = 1\ W$ $L_i = 0\ \mu H$ $C_i = 5\ nF$	
	Pulse/frequency/switch output	$U_i = DC\ 30\ V$ $I_i = 300\ mA$ $P_i = 1\ W$ $L_i = 0\ \mu H$ $C_i = 6\ nF$	
Option C	4-20mA HART	$U_i = DC\ 30\ V$ $I_i = 300\ mA$ $P_i = 1\ W$ $L_i = 0\ \mu H$ $C_i = 30\ nF$	
	4-20mA analog		
Option D	4-20mA HART	$U_i = DC\ 30\ V$ $I_i = 300\ mA$ $P_i = 1\ W$ $L_i = 0\ \mu H$ $C_i = 5\ nF$	
	Pulse/frequency/switch output	$U_i = DC\ 30\ V$ $I_i = 300\ mA$ $P_i = 1\ W$ $L_i = 0\ \mu H$ $C_i = 6\ nF$	
	4 to 20 mA current input	$U_i = DC\ 30\ V$ $I_i = 300\ mA$ $P_i = 1\ W$ $L_i = 0\ \mu H$ $C_i = 5\ nF$	
Option E	FOUNDATION Fieldbus	STANDARD $U_i = 30\ V$ $I_i = 300\ mA$ $P_i = 1.2\ W$ $L_i = 10\ \mu H$ $C_i = 5\ nF$	FISCO $U_i = 17.5\ V$ $I_i = 550\ mA$ $P_i = 5.5\ W$ $L_i = 10\ \mu H$ $C_i = 5\ nF$
	Pulse/frequency/switch output	$U_i = 30\ V$ $I_i = 300\ mA$ $P_i = 1\ W$ $L_i = 0\ \mu H$ $C_i = 6\ nF$	
Option G	PROFIBUS PA	STANDARD $U_i = 30\ V$ $I_i = 300\ mA$ $P_i = 1.2\ W$ $L_i = 10\ \mu H$ $C_i = 5\ nF$	FISCO $U_i = 17.5\ V$ $I_i = 550\ mA$ $P_i = 5.5\ W$ $L_i = 10\ \mu H$ $C_i = 5\ nF$
	Pulse/frequency/switch output	$U_i = 30\ V$ $I_i = 300\ mA$ $P_i = 1\ W$ $L_i = 0\ \mu H$ $C_i = 6\ nF$	

Type of protection Ex ic

Order code for "Output"	Output type	Intrinsically safe values	
Option A	4-20mA HART	$U_i = DC 35 V$ $I_i = n.a.$ $P_i = 1 W$ $L_i = 0 \mu H$ $C_i = 5 nF$	
Option B	4-20mA HART	$U_i = DC 35 V$ $I_i = n.a.$ $P_i = 1 W$ $L_i = 0 \mu H$ $C_i = 5 nF$	
	Pulse/frequency/switch output	$U_i = DC 35 V$ $I_i = n.a.$ $P_i = 1 W$ $L_i = 0 \mu H$ $C_i = 6 nF$	
Option C	4-20mA HART	$U_i = DC 30 V$ $I_i = n.a.$ $P_i = 1 W$ $L_i = 0 \mu H$ $C_i = 30 nF$	
	4-20mA analog		
Option D	4-20mA HART	$U_i = DC 35 V$ $I_i = n.a.$ $P_i = 1 W$ $L_i = 0 \mu H$ $C_i = 5 nF$	
	Pulse/frequency/switch output	$U_i = DC 35 V$ $I_i = n.a.$ $P_i = 1 W$ $L_i = 0 \mu H$ $C_i = 6 nF$	
	4 to 20 mA current input	$U_i = DC 35 V$ $I_i = n.a.$ $P_i = 1 W$ $L_i = 0 \mu H$ $C_i = 5 nF$	
Option E	FOUNDATION Fieldbus	STANDARD $U_i = 32 V$ $I_i = 300 mA$ $P_i = n.a.$ $L_i = 10 \mu H$ $C_i = 5 nF$	FISCO $U_i = 17.5 V$ $I_i = n.a.$ $P_i = n.a.$ $L_i = 10 \mu H$ $C_i = 5 nF$
	Pulse/frequency/switch output	$U_i = 35 V$ $I_i = 300 mA$ $P_i = 1 W$ $L_i = 0 \mu H$ $C_i = 6 nF$	
Option G	PROFIBUS PA	STANDARD $U_i = 32 V$ $I_i = 300 mA$ $P_i = n.a.$ $L_i = 10 \mu H$ $C_i = 5 nF$	FISCO $U_i = 17.5 V$ $I_i = n.a.$ $P_i = n.a.$ $L_i = 10 \mu H$ $C_i = 5 nF$
	Pulse/frequency/switch output	$U_i = 35 V$ $I_i = 300 mA$ $P_i = 1 W$ $L_i = 0 \mu H$ $C_i = 6 nF$	

Type of protection IS

Order code for "Output"	Output type	Intrinsically safe values	
Option A	4-20mA HART	$U_i = DC\ 30\ V$ $I_i = 300\ mA$ $P_i = 1\ W$ $L_i = 0\ \mu H$ $C_i = 5\ nF$	
Option B	4-20mA HART	$U_i = DC\ 30\ V$ $I_i = 300\ mA$ $P_i = 1\ W$ $L_i = 0\ \mu H$ $C_i = 5\ nF$	
	Pulse/frequency/switch output	$U_i = DC\ 30\ V$ $I_i = 300\ mA$ $P_i = 1\ W$ $L_i = 0\ \mu H$ $C_i = 6\ nF$	
Option C	4-20mA HART	$U_i = DC\ 30\ V$ $I_i = 300\ mA$ $P_i = 1\ W$ $L_i = 0\ \mu H$ $C_i = 30\ nF$	
	4-20mA analog		
Option D	4-20mA HART	$U_i = DC\ 30\ V$ $I_i = 300\ mA$ $P_i = 1\ W$ $L_i = 0\ \mu H$ $C_i = 5\ nF$	
	Pulse/frequency/switch output	$U_i = DC\ 30\ V$ $I_i = 300\ mA$ $P_i = 1\ W$ $L_i = 0\ \mu H$ $C_i = 6\ nF$	
	4 to 20 mA current input	$U_i = DC\ 30\ V$ $I_i = 300\ mA$ $P_i = 1\ W$ $L_i = 0\ \mu H$ $C_i = 5\ nF$	
Option E	FOUNDATION Fieldbus	STANDARD $U_i = 30\ V$ $I_i = 300\ mA$ $P_i = 1.2\ W$ $L_i = 10\ \mu H$ $C_i = 5\ nF$	FISCO $U_i = 17.5\ V$ $I_i = 550\ mA$ $P_i = 5.5\ W$ $L_i = 10\ \mu H$ $C_i = 5\ nF$
	Pulse/frequency/switch output	$U_i = 30\ V$ $I_i = 300\ mA$ $P_i = 1\ W$ $L_i = 0\ \mu H$ $C_i = 6\ nF$	
Option G	PROFIBUS PA	STANDARD $U_i = 30\ V$ $I_i = 300\ mA$ $P_i = 1.2\ W$ $L_i = 10\ \mu H$ $C_i = 5\ nF$	FISCO $U_i = 17.5\ V$ $I_i = 550\ mA$ $P_i = 5.5\ W$ $L_i = 10\ \mu H$ $C_i = 5\ nF$
	Pulse/frequency/switch output	$U_i = 30\ V$ $I_i = 300\ mA$ $P_i = 1\ W$ $L_i = 0\ \mu H$ $C_i = 6\ nF$	

Low flow cut off

The switch points for low flow cut off are preset and can be configured.

Galvanic isolation

All inputs and outputs are galvanically isolated from one another.

Protocol-specific data**HART**

Manufacturer ID	0x11
Device type ID	0x0038
HART protocol revision	7
Device description files (DTM, DD)	Information and files under: www.endress.com
HART load	<ul style="list-style-type: none"> ▪ Min. 250 Ω ▪ Max. 500 Ω
System integration	For information on system integration, see Operating Instructions. → 98 <ul style="list-style-type: none"> ▪ Measured variables via HART protocol ▪ Burst Mode functionality

FOUNDATION Fieldbus

Manufacturer ID	0x452B48
Ident number	0x1038
Device revision	2
DD revision	Information and files under:
CFF revision	<ul style="list-style-type: none"> ▪ www.endress.com ▪ www.fieldbus.org
Device Tester Version (ITK version)	6.2.0
ITK Test Campaign Number	Information: <ul style="list-style-type: none"> ▪ www.endress.com ▪ www.fieldbus.org
Link Master capability (LAS)	Yes
Choice of "Link Master" and "Basic Device"	Yes Factory setting: Basic Device
Node address	Factory setting: 247 (0xF7)
Supported functions	The following methods are supported: <ul style="list-style-type: none"> ▪ Restart ▪ ENP Restart ▪ Diagnostic ▪ Read events ▪ Read trend data
Virtual Communication Relationships (VCRs)	
Number of VCRs	44
Number of link objects in VFD	50
Permanent entries	1
Client VCRs	0
Server VCRs	10
Source VCRs	43
Sink VCRs	0
Subscriber VCRs	43
Publisher VCRs	43
Device Link Capabilities	
Slot time	4

Min. delay between PDU	8
Max. response delay	Min. 5
System integration	For information on system integration, see Operating Instructions. → 98 <ul style="list-style-type: none"> ▪ Cyclic data transmission ▪ Description of the modules ▪ Execution times ▪ Methods

PROFIBUS PA

Manufacturer ID	0x11
Ident number	0x1564
Profile version	3.02
Device description files (GSD, DTM, DD)	Information and files under: <ul style="list-style-type: none"> ▪ www.endress.com ▪ www.profibus.org
Supported functions	<ul style="list-style-type: none"> ▪ Identification & Maintenance Simple device identification via control system and nameplate ▪ PROFIBUS upload/download Reading and writing parameters is up to ten times faster with PROFIBUS upload/download ▪ Condensed status Simplest and self-explanatory diagnostic information by categorizing diagnostic messages that occur
Configuration of the device address	<ul style="list-style-type: none"> ▪ DIP switches on the I/O electronics module ▪ Local display ▪ Via operating tools (e. g. FieldCare)
System integration	For information on system integration, see Operating Instructions. → 98 <ul style="list-style-type: none"> ▪ Cyclic data transmission ▪ Block model ▪ Description of the modules

Power supply

Terminal assignment

Transmitter

Connection versions

<p><i>Maximum number of terminals</i> Terminals 1 to 6: <i>Without integrated overvoltage protection</i></p>	<p><i>Maximum number of terminals for order code for "Accessory mounted", option NA "Overvoltage protection"</i></p> <ul style="list-style-type: none"> ▪ Terminals 1 to 4: <i>With integrated overvoltage protection</i> ▪ Terminals 5 to 6: <i>Without integrated overvoltage protection</i>
<p>1 <i>Output 1 (passive): supply voltage and signal transmission</i> 2 <i>Output 2 (passive): supply voltage and signal transmission</i> 3 <i>Input (passive): supply voltage and signal transmission</i> 4 <i>Ground terminal for cable shield</i></p>	

Order code for "Output"	Terminal numbers					
	Output 1		Output 2		Input	
	1 (+)	2 (-)	3 (+)	4 (-)	5 (+)	6 (-)
Option A	4-20 mA HART (passive)		-		-	
Option B ¹⁾	4-20 mA HART (passive)		Pulse/frequency/switch output (passive)		-	
Option C ¹⁾	4-20 mA HART (passive)		4-20 mA analog (passive)		-	
Option D ^{1) 2)}	4-20 mA HART (passive)		Pulse/frequency/switch output (passive)		4-20 mA current input (passive)	
Option E ^{1) 3)}	FOUNDATION Fieldbus		Pulse/frequency/switch output (passive)		-	
Option G ^{1) 4)}	PROFIBUS PA		Pulse/frequency/switch output (passive)		-	

- 1) Output 1 must always be used; output 2 is optional.
- 2) The integrated overvoltage protection is not used with option D: Terminals 5 and 6 (current input) are not protected against overvoltage.
- 3) FOUNDATION Fieldbus with integrated reverse polarity protection.
- 4) PROFIBUS PA with integrated reverse polarity protection.

Connecting cable for remote version

Transmitter and sensor connection housing

In the case of the remote version, the sensor and transmitter are mounted separately from on another and connected by a connecting cable. Connection is performed via the sensor connection housing and the transmitter housing.

 How the connecting cable is connected in the transmitter housing depends on the measuring device approval and the version of the connecting cable used.

In the following versions, only terminals can be used for connection in the transmitter housing:

- Certain approvals: Ex nA, Ex ec, Ex tb and Division 1
- Use of reinforced connecting cable
- Order code for "Sensor version; DSC sensor; measuring tube", option DA, DB

In the following versions, an M12 device connector is used for connection in the transmitter housing:

- All other approvals
- Use of connecting cable (standard)

Terminals are always used to connect the connecting cable in the sensor connection housing (tightening torques for screws for cable strain relief: 1.2 to 1.7 Nm).

Connecting cable (standard, reinforced)

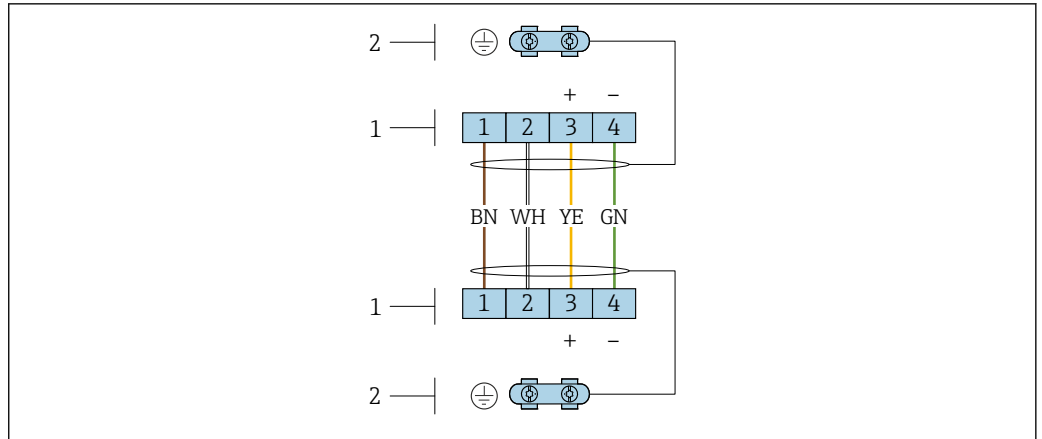

A0033476

3 Terminals for connection compartment in the transmitter wall holder and the sensor connection housing
 1 Terminals for connecting cable
 2 Grounding via the cable strain relief

Terminal number	Assignment	Cable color Connecting cable
1	Supply voltage	Brown
2	Grounding	White
3	RS485 (+)	Yellow
4	RS485 (-)	Green

Connecting cable (option "mass pressure-/temperature-compensated")

Order code for "Sensor version; DSC sensor; measuring tube", option DA, DB

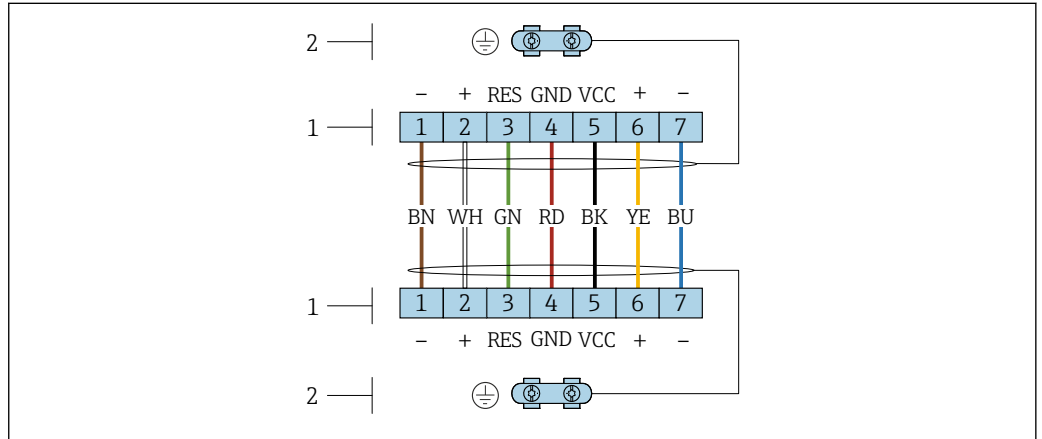

A0034571

4 Terminals for connection compartment in the transmitter wall holder and the sensor connection housing
 1 Terminals for connecting cable
 2 Grounding via the cable strain relief

Terminal number	Assignment	Cable color Connecting cable
1	RS485 (-) DPC	Brown
2	RS485 (+) DPC	White
3	Reset	Green
4	Supply voltage	red

Terminal number	Assignment	Cable color Connecting cable
5	Grounding	Black
6	RS485 (+)	Yellow
7	RS485 (-)	Blue

Pin assignment, device plug

PROFIBUS PA

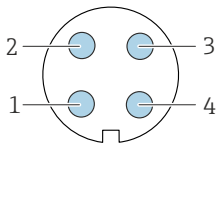
	Pin	Assignment	Coding	Plug/socket	
	1	+	PROFIBUS PA +	A	Plug
	2		Grounding		
	3	-	PROFIBUS PA -		
	4		Not assigned		

FOUNDATION Fieldbus

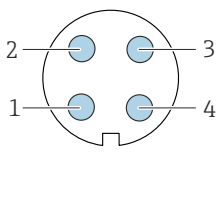
	Pin	Assignment	Coding	Plug/socket	
	1	+	Signal +	A	Plug
	2	-	Signal -		
	3		Grounding		
	4		Not assigned		

Supply voltage

Transmitter

An external power supply is required for each output.

Supply voltage for a compact version without a local display ¹⁾

Order code for "Output; input"	Minimum terminal voltage ²⁾	Maximum terminal voltage
Option A: 4-20 mA HART	≥ DC 12 V	DC 35 V
Option B: 4-20 mA HART, pulse/frequency/switch output	≥ DC 12 V	DC 35 V
Option C: 4-20 mA HART + 4-20 mA analog	≥ DC 12 V	DC 30 V
Option D: 4-20 mA HART, pulse/frequency/switch output, 4-20 mA current input ³⁾	≥ DC 12 V	DC 35 V
Option E: FOUNDATION Fieldbus, pulse/frequency/switch output	≥ DC 9 V	DC 32 V
Option G: PROFIBUS PA, pulse/frequency/switch output	≥ DC 9 V	DC 32 V

1) In event of external supply voltage of the power supply unit with load, the PROFIBUS DP/PA coupler or FOUNDATION Fieldbus power conditioners



2) The minimum terminal voltage increases if local operation is used: see the following table



3) Voltage drop 2.2 to 3 V for 3.59 to 22 mA



Increase in minimum terminal voltage

Order code for "Display; operation"	Increase in minimum terminal voltage
Option C: Local operation SD02	+ DC 1 V
Option E: Local operation SD03 with lighting (backlighting not used)	+ DC 1 V
Option E: Local operation SD03 with lighting (backlighting used)	+ DC 3 V

Order code for "Sensor version; DSC sensor; measuring tube"	Increase in minimum terminal voltage
Option DA: Mass steam; 316L; 316L (integrated pressure/temperature measurement)	+ DC 1 V
Option DB: Mass gas/liquid; 316L; 316L (integrated pressure/temperature measurement)	+ DC 1 V

 For information about the load see →  20

 Various power supply units can be ordered from Endress+Hauser: →  97

 For information on the Ex connection values →  21

Power consumption

Transmitter

Order code for "Output; input"	Maximum power consumption
Option A: 4-20 mA HART	770 mW
Option B: 4-20 mA HART, pulse/frequency/switch output	<ul style="list-style-type: none"> ▪ Operation with output 1: 770 mW ▪ Operation with output 1 and 2: 2 770 mW
Option C: 4-20 mA HART + 4-20 mA analog	<ul style="list-style-type: none"> ▪ Operation with output 1: 660 mW ▪ Operation with output 1 and 2: 1 320 mW
Option D: 4-20 mA HART, pulse/frequency/switch output, 4-20 mA current input	<ul style="list-style-type: none"> ▪ Operation with output 1: 770 mW ▪ Operation with output 1 and 2: 2 770 mW ▪ Operation with output 1 and input: 840 mW ▪ Operation with output 1, 2 and input: 2840 mW
Option E: FOUNDATION Fieldbus, pulse/frequency/switch output	<ul style="list-style-type: none"> ▪ Operation with output 1: 512 mW ▪ Operation with output 1 and 2: 2 512 mW
Option G: PROFIBUS PA, pulse/frequency/switch output	<ul style="list-style-type: none"> ▪ Operation with output 1: 512 mW ▪ Operation with output 1 and 2: 2 512 mW

 For information on the Ex connection values →  21

Current consumption

Current output

For every 4-20 mA or 4-20 mA HART current output: 3.6 to 22.5 mA

 If the option **Defined value** is selected in the **Failure mode** parameter : 3.59 to 22.5 mA

Current input

3.59 to 22.5 mA

 Internal current limiting: max. 26 mA**FOUNDATION Fieldbus**

15 mA

PROFIBUS PA

15 mA

Power supply failure

Depending on the device version, the configuration is retained in the device memory or in the pluggable data memory (HistoROM DAT).

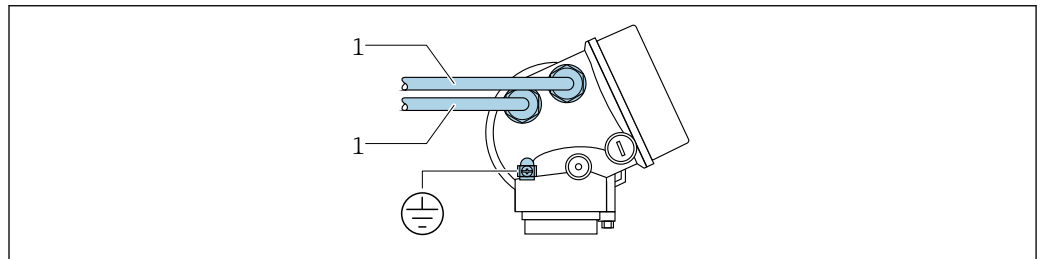
Electrical connection**Connecting the transmitter**

A0033480

1 Cable entries for inputs/outputs

Remote version connection

Connecting cable

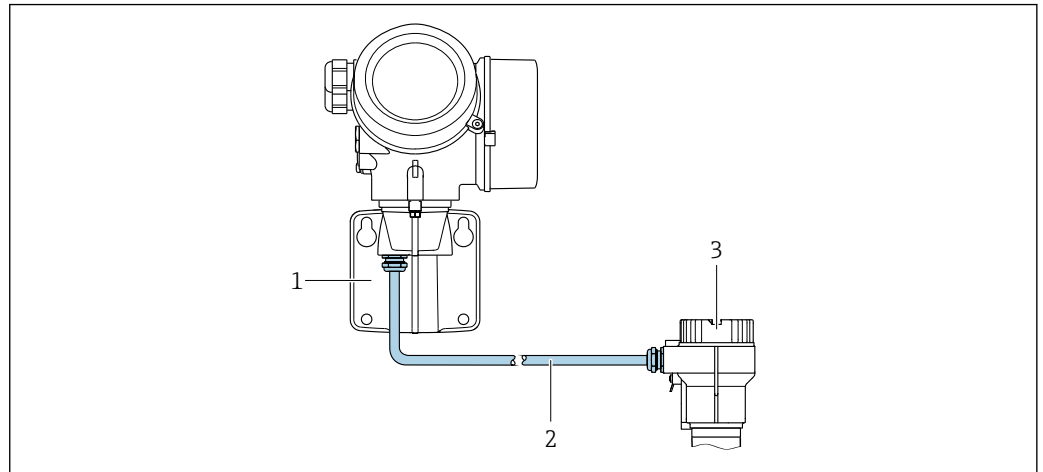

A0033481

5 *Connecting cable connection*

- 1 Wall holder with connection compartment (transmitter)
- 2 Connecting cable
- 3 Sensor connection housing

i How the connecting cable is connected in the transmitter housing depends on the measuring device approval and the version of the connecting cable used.

In the following versions, only terminals can be used for connection in the transmitter housing:

- Certain approvals: Ex nA, Ex ec, Ex tb and Division 1
- Use of reinforced connecting cable

- Order code for "Sensor version; DSC sensor; measuring tube", option DA, DB

In the following versions, an M12 device connector is used for connection in the transmitter housing:

- All other approvals
- Use of connecting cable (standard)

Terminals are always used to connect the connecting cable in the sensor connection housing (tightening torques for screws for cable strain relief: 1.2 to 1.7 Nm).

Connection examples

Current output 4-20 mA HART

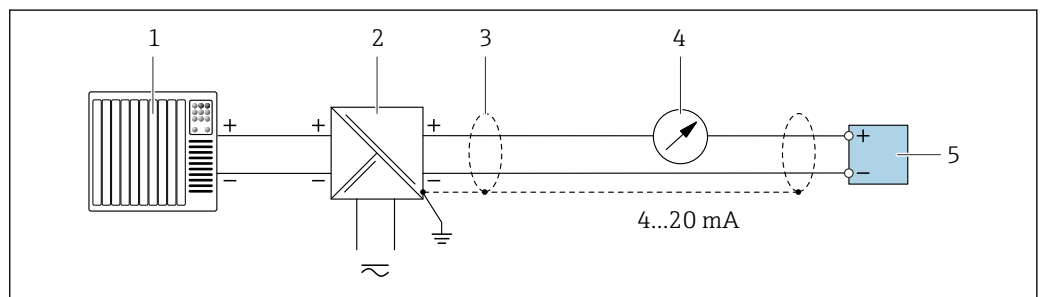

A0028762

6 *Connection example for 4 to 20 mA HART current output (passive)*

- 1 Automation system with current input (e.g. PLC)
- 2 Power supply
- 3 Cable shield: the cable shield must be grounded at both ends to comply with EMC requirements; observe cable specifications
- 4 Analog display unit: observe maximum load
- 5 Transmitter

Pulse/frequency output

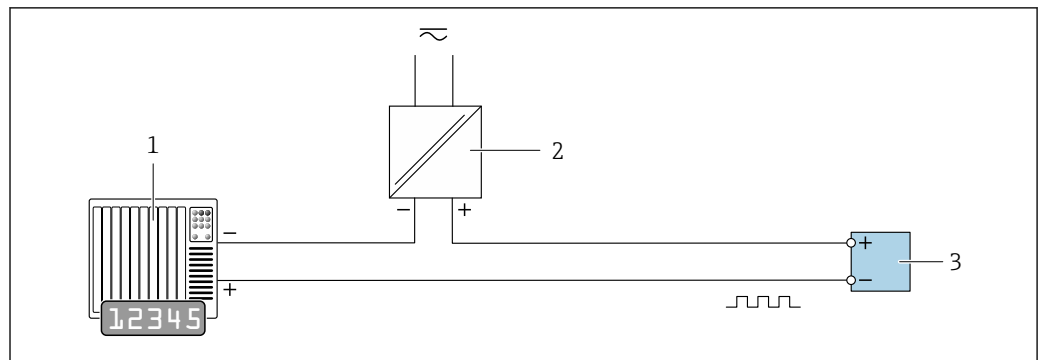

A0028761

7 Connection example for pulse/frequency output (passive)

- 1 Automation system with pulse/frequency input (e.g. PLC)
- 2 Power supply
- 3 Transmitter: Observe input values

Switch output

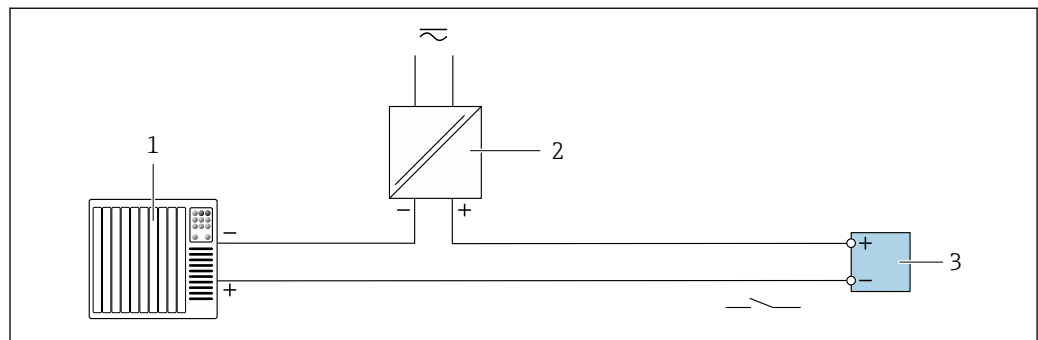

A0028760

8 Connection example for switch output (passive)

- 1 Automation system with switch input (e.g. PLC)
- 2 Power supply
- 3 Transmitter: Observe input values

FOUNDATION Fieldbus

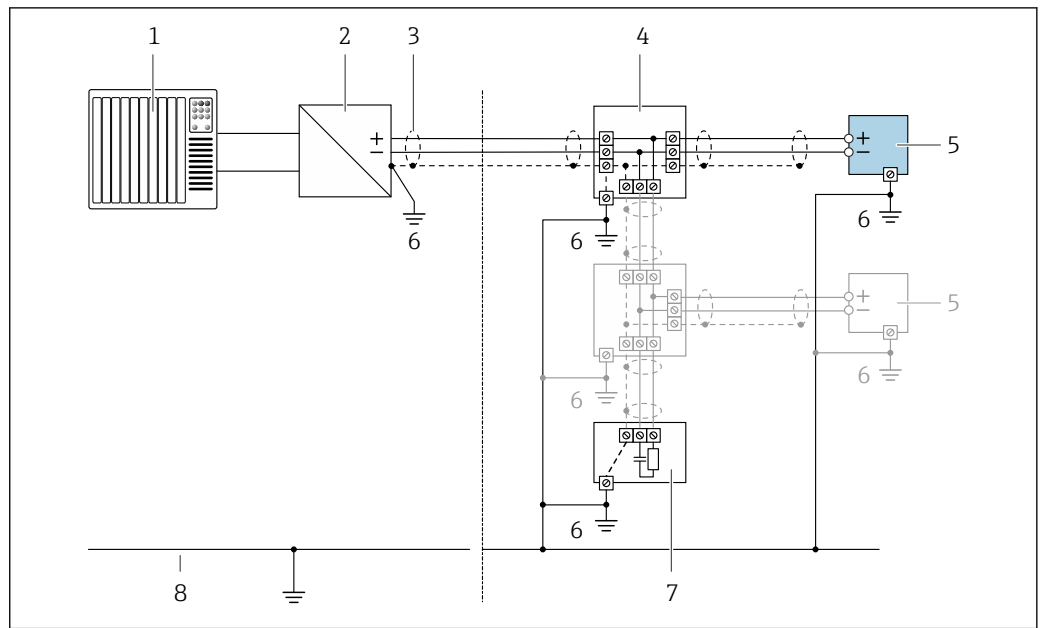

A0028768

9 Connection example for FOUNDATION Fieldbus

- 1 Control system (e.g. PLC)
- 2 Power Conditioner (FOUNDATION Fieldbus)
- 3 Cable shield: the cable shield must be grounded at both ends to comply with EMC requirements; observe cable specifications
- 4 T-box
- 5 Measuring device
- 6 Local grounding
- 7 Bus terminator
- 8 Potential matching line

PROFIBUS-PA

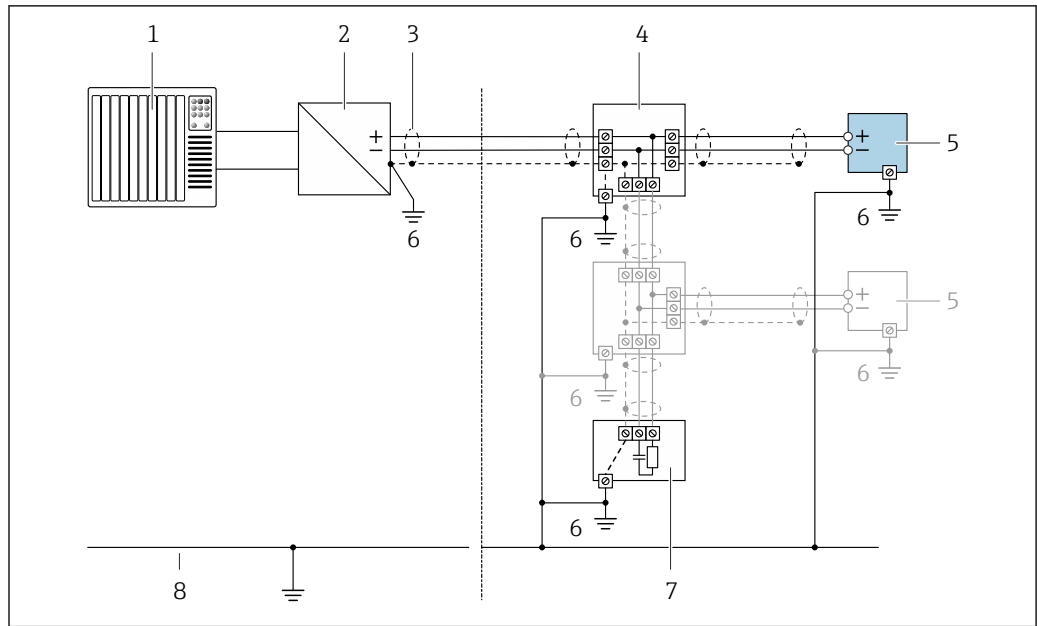

A0028768

10 Connection example for PROFIBUS-PA

- 1 Control system (e.g. PLC)
- 2 PROFIBUS PA segment coupler
- 3 Cable shield: the cable shield must be grounded at both ends to comply with EMC requirements; observe cable specifications
- 4 T-box
- 5 Measuring device
- 6 Local grounding
- 7 Bus terminator
- 8 Potential matching line

Current input

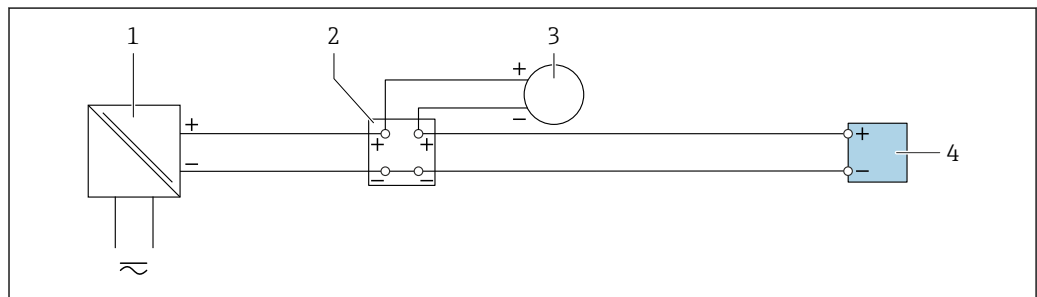

A0028915

11 Connection example for 4-20 mA current input

- 1 Active barrier for power supply (e.g. RN221N)
- 2 Terminal box
- 3 External measuring device (for reading in pressure or temperature, for instance)
- 4 Transmitter: Observe input values → 16

HART input

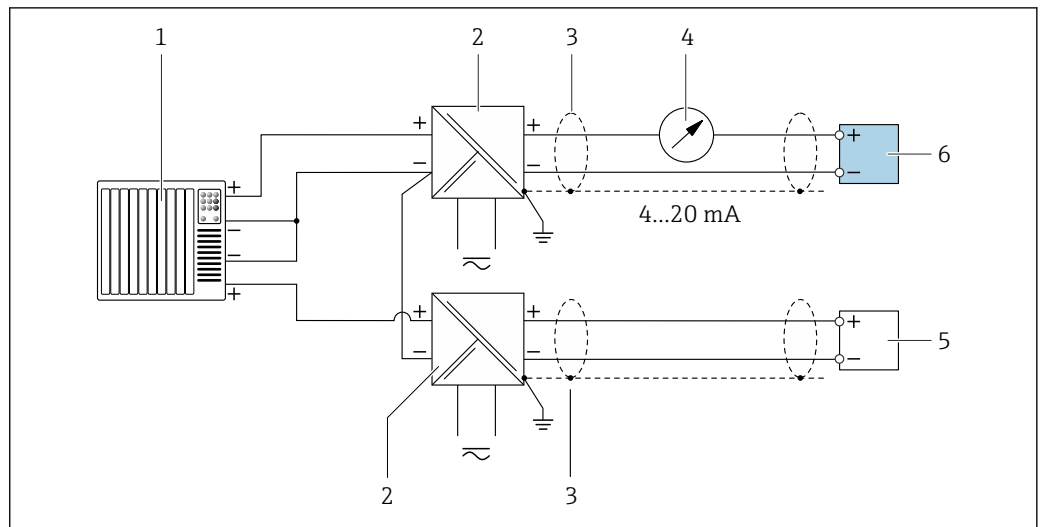

A0028763

12 Connection example for HART input with a common negative (passive)

- 1 Automation system with HART output (e.g. PLC)
- 2 Active barrier for power supply (e.g. RN221N)
- 3 Cable shield: the cable shield must be grounded at both ends to comply with EMC requirements; observe cable specifications
- 4 Analog display unit: observe maximum load
- 5 Pressure measuring device (e.g. Cerabar M, Cerabar S): see requirements
- 6 Transmitter

Potential equalization

Requirements

Please consider the following to ensure correct measurement:

- Same electrical potential for the fluid and sensor
- Remote version: same electrical potential for the sensor and transmitter
- Company-internal grounding concepts
- Pipe material and grounding

Terminals

- For device version without integrated overvoltage protection: plug-in spring terminals for wire cross-sections 0.5 to 2.5 mm² (20 to 14 AWG)
- For device version with integrated overvoltage protection: screw terminals for wire cross-sections 0.2 to 2.5 mm² (24 to 14 AWG)

Cable entries

- Cable gland (not for Ex d): M20 × 1.5 with cable Ø 6 to 12 mm (0.24 to 0.47 in)
- Thread for cable entry:
 - For non-hazardous and hazardous areas: NPT ½"
 - For non-hazardous and hazardous areas (not for XP): G ½"
 - For Ex d: M20 × 1.5

Cable specification

Permitted temperature range

- The installation guidelines that apply in the country of installation must be observed.
- The cables must be suitable for the minimum and maximum temperatures to be expected.

Signal cable

Current output 4 to 20 mA HART

A shielded cable is recommended. Observe grounding concept of the plant.

Current output 4 to 20 mA

Standard installation cable is sufficient.

Pulse/frequency/switch output

Standard installation cable is sufficient.

Current input

Standard installation cable is sufficient.

FOUNDATION Fieldbus

Twisted, shielded two-wire cable.



For further information on planning and installing FOUNDATION Fieldbus networks see:

- Operating Instructions for "FOUNDATION Fieldbus Overview" (BA00013S)
- FOUNDATION Fieldbus Guideline
- IEC 61158-2 (MBP)

PROFIBUS PA

Twisted, shielded two-wire cable. Cable type A is recommended .



For further information on planning and installing PROFIBUS PA networks see:

- Operating Instructions "PROFIBUS DP/PA: Guidelines for planning and commissioning" (BA00034S)
- PNO Directive 2.092 "PROFIBUS PA User and Installation Guideline"
- IEC 61158-2 (MBP)

Connecting cable for remote version*Connecting cable (standard)*

Standard cable	2 × 2 × 0.5 mm ² (22 AWG) PVC cable with common shield (2 pairs, pair-stranded) ¹⁾
Flame resistance	According to DIN EN 60332-1-2
Oil-resistance	According to DIN EN 60811-2-1
Shielding	Galvanized copper-braid, opt. density approx.85 %
Cable length	5 m (16 ft), 10 m (32 ft), 20 m (65 ft), 30 m (98 ft)
Operating temperature	When mounted in a fixed position: -50 to +105 °C (-58 to +221 °F); when cable can move freely: -25 to +105 °C (-13 to +221 °F)

- 1) UV radiation may cause damage to the outer jacket of the cable. Protect the cable from exposure to sun as much as possible.

Connecting cable (reinforced)

Cable, reinforced	2 × 2 × 0.34 mm ² (22 AWG) PVC cable with common shield (2 pairs, pair-stranded) and additional steel-wire braided sheath ¹⁾
Flame resistance	According to DIN EN 60332-1-2
Oil-resistance	According to DIN EN 60811-2-1
Shielding	Galvanized copper-braid, opt. density approx. 85%
Strain relief and reinforcement	Steel-wire braid, galvanized
Cable length	5 m (16 ft), 10 m (32 ft), 20 m (65 ft), 30 m (98 ft)
Operating temperature	When mounted in a fixed position: -50 to +105 °C (-58 to +221 °F); when cable can move freely: -25 to +105 °C (-13 to +221 °F)

- 1) UV radiation may cause damage to the outer jacket of the cable. Protect the cable from exposure to sun as much as possible.

Connecting cable (option "mass pressure-/temperature-compensated")

Order code for "Sensor version; DSC sensor; measuring tube", option DA, DB

Standard cable	$[(3 \times 2) + 1] \times 0.34 \text{ mm}^2$ (22 AWG)PVC cable with common shield (3 pairs, pair-stranded) ¹⁾
Flame resistance	According to DIN EN 60332-1-2
Oil-resistance	According to DIN EN 60811-2-1
Shielding	Galvanized copper-braid, opt. density approx. 85%
Cable length	10 m (32 ft), 30 m (98 ft)
Operating temperature	When mounted in a fixed position: -50 to +105 °C (-58 to +221 °F); when cable can move freely: -25 to +105 °C (-13 to +221 °F)

- 1) UV radiation may cause damage to the outer jacket of the cable. Protect the cable from exposure to sun as much as possible.

Connecting cable (option "mass pressure-/temperature-compensated")

Order code for "Sensor version; DSC sensor; measuring tube", option DA, DB

Standard cable	$[(3 \times 2) + 1] \times 0.34 \text{ mm}^2$ (22 AWG)PVC cable with common shield (3 pairs, pair-stranded) ¹⁾
Flame resistance	According to DIN EN 60332-1-2
Oil-resistance	According to DIN EN 60811-2-1
Shielding	Galvanized copper-braid, opt. density approx. 85%
Cable length	10 m (32 ft), 30 m (98 ft)
Operating temperature	When mounted in a fixed position: -50 to +105 °C (-58 to +221 °F); when cable can move freely: -25 to +105 °C (-13 to +221 °F)

- 1) UV radiation may cause damage to the outer jacket of the cable. Protect the cable from exposure to sun as much as possible.

Overvoltage protection

The device can be ordered with integrated overvoltage protection for diverse approvals:

Order code for "Accessory mounted", option NA "Overvoltage protection"

Input voltage range	Values correspond to supply voltage specifications →  30 ¹⁾
Resistance per channel	2 · 0.5 Ω max.
DC sparkover voltage	400 to 700 V
Trip surge voltage	< 800 V
Capacitance at 1 MHz	< 1.5 pF
Nominal discharge current (8/20 μs)	10 kA
Temperature range	-40 to +85 °C (-40 to +185 °F)

- 1) The voltage is reduced by the amount of the internal resistance $I_{min} \cdot R_i$



Depending on the temperature class, restrictions apply to the ambient temperature for device versions with overvoltage protection .





For detailed information on the temperature tables, see the "Safety Instructions" (XA) for the device.

Performance characteristics

Reference operating conditions

- Error limits following ISO/DIN 11631
- +20 to +30 °C (+68 to +86 °F)
- 2 to 4 bar (29 to 58 psi)
- Calibration system traceable to national standards
- Calibration with the process connection corresponding to the particular standard

 To obtain measured errors, use the *Applicator* sizing tool →  97



Maximum measured error

Base accuracy

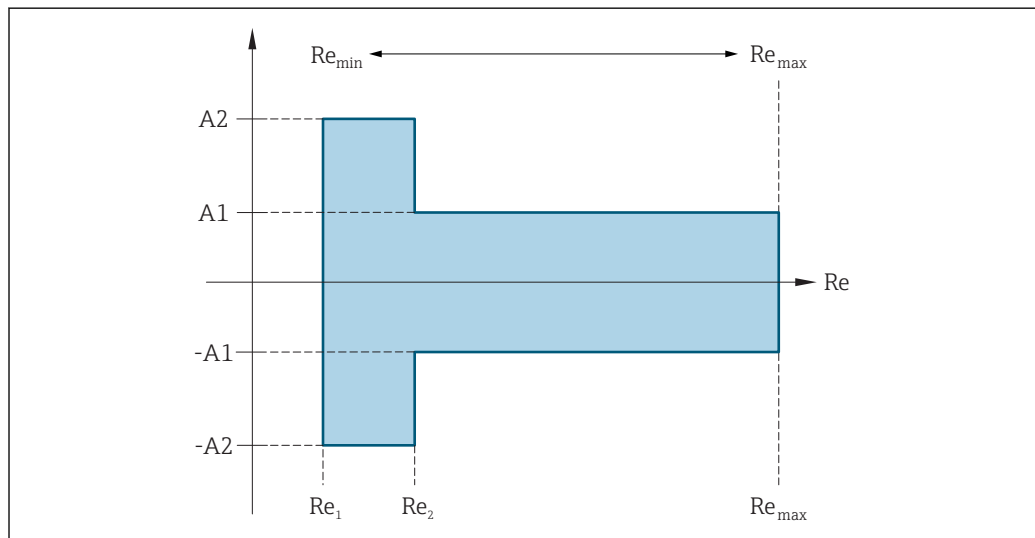
o.r. = of reading



A0034077

Reynolds number	
Re ₁	5 000
Re ₂	10 000
Re _{min}	Reynolds number for minimum permitted volume flow in measuring tube <ul style="list-style-type: none"> ▪ Standard ▪ Option N "0.65% volume PremiumCal 5-point, extended turndown" $Q_{\text{AmpMin}} [\text{m}^3/\text{h}] = \frac{v_{\text{AmpMin}} [\text{m/s}] \cdot \pi \cdot D_i [\text{m}]^2}{4 \cdot \sqrt{\frac{\rho [\text{kg}/\text{m}^3]}{1 [\text{kg}/\text{m}^3]}}} \cdot 3600 [\text{s/h}]$ $Q_{\text{AmpMin}} [\text{ft}^3/\text{min}] = \frac{v_{\text{AmpMin}} [\text{ft/s}] \cdot \pi \cdot D_i [\text{ft}]^2}{4 \cdot \sqrt{\frac{\rho [\text{lbm}/\text{ft}^3]}{0.0624 [\text{lbm}/\text{ft}^3]}}} \cdot 60 [\text{s/min}]$
Re _{max}	Defined by internal diameter of measuring tube, Mach number and maximum permitted velocity in measuring tube $Re_{\text{max}} = \frac{\rho \cdot 4 \cdot Q_{\text{Heigh}}}{\mu \cdot K}$ <p> Further information on effective upper range value Q_{High} →  14</p>

A0034304

A0034339

Volume flow

Medium type		Incompressible		Compressible	
Reynolds number Window	Measured value deviation	PremiumCal ¹⁾	Standard	PremiumCal ¹⁾	Standard
Re ₂ to Re _{max}	A1	< 0.65 %	< 0.75 %	< 0.9 %	< 1.0 %
Re ₁ to Re ₂	A2	< 2.5 %	< 5.0 %	< 2.5 %	< 5.0 %

1) Order code for "Calibration flow", option N "0.65% volume PremiumCal 5-point, extended turndown"

Temperature

- Saturated steam and liquids at room temperature, if T > 100 °C (212 °F):
< 1 °C (1.8 °F)
- Gas: < 1 % o.r. [K]
- Volume flow: 70 m/s (230 ft/s): 2 % o.r.
- Rise time 50 % (stirred under water, following IEC 60751): 8 s

Pressure

Order code for "Pressure component" ¹⁾	Nominal value [bar abs.]	Pressure ranges and measured errors ²⁾	
		Pressure range [bar abs.]	Maximum measured error
Option B Pressure measuring cell 2 bar_a	2	0.01 ≤ p ≤ 0.4 0.4 ≤ p ≤ 2	0.5 % of 0.4 abs. 0.5 % o.r.
Option C Pressure measuring cell 4 bar_a	4	0.01 ≤ p ≤ 0.8 0.8 ≤ p ≤ 4	0.5 % of 0.8 bar abs. 0.5 % o.r.
Option D Pressure measuring cell 10 bar_a	10	0.01 ≤ p ≤ 2 2 ≤ p ≤ 10	0.5 % of 2 bar abs. 0.5 % o.r.
Option E Pressure measuring cell 40 bar_a	40	0.01 ≤ p ≤ 8 8 ≤ p ≤ 40	0.5 % of 8 bar abs. 0.5 % o.r.
Option F Pressure measuring cell 100 bar_a	100	0.01 ≤ p ≤ 20 20 ≤ p ≤ 100	0.5 % of 20 bar abs. 0.5 % o.r.

- 1) The "mass" sensor version (integrated pressure/temperature measurement) is available only for measuring devices in HART communication mode.
- 2) The specific measured errors refer to the position of the measurement in the measuring tube and do not correspond to the pressure in the pipe connection line upstream or downstream from the measuring device. No measured error is specified for the measured error for the "pressure" measured variable that can be assigned to the outputs.

Mass flow saturated steam

Sensor version				Mass (integrated temperature measurement)		Mass (integrated pressure/temperature measurement) ¹⁾	
Process pressure [bar abs.]	Flow velocity [m/s (ft/s)]	Reynolds number Window	Measured value deviation	PremiumCal ²⁾	Standard	PremiumCal ²⁾	Standard
> 4.76	20 to 50 (66 to 164)	Re ₂ to Re _{max}	A1	< 1.6 %	< 1.7 %	< 1.4 %	< 1.5 %
> 3.62	10 to 70 (33 to 230)	Re ₂ to Re _{max}	A1	< 1.9 %	< 2.0 %	< 1.7 %	< 1.8 %

In all cases not specified here, the following applies: < 5.7 %

- 1) Sensor version available only for measuring devices in HART communication mode.
- 2) Order code for "Calibration flow", option N "0.65% volume PremiumCal 5-point, extended turndown"

Mass flow of superheated steam/gases³⁾

Sensor version				Mass (integrated pressure/temperature measurement) ¹⁾		Mass (integrated temperature measurement) + external pressure compensation ²⁾	
Process pressure [bar abs.]	Flow velocity [m/s (ft/s)]	Reynolds number Window	Measured value deviation	PremiumCal ³⁾	Standard	PremiumCal ³⁾	Standard
< 40	All velocities	Re ₂ to Re _{max}	A1	< 1.4 %	< 1.5 %	< 1.6 %	< 1.7 %
< 120		Re ₂ to Re _{max}	A1	< 2.3 %	< 2.4 %	< 2.5 %	< 2.6 %
In all cases not specified here, the following applies: < 6.6 %							

- 1) Sensor version available only for measuring devices in HART communication mode.
- 2) The use of a Cerabar S is required for the measured errors listed in the following section. The measured error used to calculate the error in the measured pressure is 0.15 %.
- 3) Order code for "Calibration flow", option N "0.65% volume PremiumCal 5-point, extended turndown"

Water mass flow

Sensor version				Mass (integrated temperature measurement)	
Process pressure [bar abs.]	Flow velocity [m/s (ft/s)]	Reynolds number Window	Measured value deviation	PremiumCal ¹⁾	Standard
All pressures	All velocities	Re ₂ to Re _{max}	A1	< 0.75 %	< 0.85 %
		Re ₁ to Re ₂	A2	< 2.6 %	< 2.7 %

- 1) Order code for "Calibration flow", option N "0.65% volume PremiumCal 5-point, extended turndown"

Mass flow (user-specific liquids)

To specify the system accuracy, Endress+Hauser requires information about the type of liquid and its operating temperature or information in table form about the dependency between the liquid density and the temperature.

Example

- Acetone is to be measured at fluid temperatures from +70 to +90 °C (+158 to +194 °F).
- For this purpose, the **Reference temperature** parameter (7703) (here 80 °C (176 °F)), **Reference density** parameter (7700) (here 720.00 kg/m³) and **Linear expansion coefficient** parameter (7621) (here $18.0298 \times 10^{-4} 1/^{\circ}\text{C}$) must be entered in the transmitter.
- The overall system uncertainty, which is less than 0.9 % for the example above, is comprised of the following measurement uncertainties: uncertainty of volume flow measurement, uncertainty of temperature measurement, uncertainty of the density-temperature correlation used (including the resulting uncertainty of density).

Mass flow (other media)

Depends on the selected fluid and the pressure value, which is specified in the parameters. Individual error analysis must be performed.

Diameter mismatch correction

The measuring device can correct shifts in the calibration factor which are caused, for example, by a diameter mismatch between the device flange (e.g. ASME B16.5/Sch. 80, DN 50 (2")) and the mating pipe (e.g. ASME B16.5/Sch. 40, DN 50 (2")). Only apply diameter mismatch correction within the following limit values (listed below) for which test measurements have also been performed.

- 3) single gas, gas mixture, air: NEL40; natural gas: ISO 12213-2 contains AGA8-DC92, AGA NX-19, ISO 12213-3 contains SGERG-88 and AGA8 Gross Method 1

Flange connection:

- DN 15 (½"): ±20 % of the internal diameter
- DN 25 (1"): ±15 % of the internal diameter
- DN 40 (1½"): ±12 % of the internal diameter
- DN ≥ 50 (2"): ±10 % of the internal diameter

If the standard internal diameter of the ordered process connection differs from the internal diameter of the mating pipe, an additional measuring uncertainty of approx. 2 % o.r. must be expected.

Example

Influence of the diameter mismatch without using the correction function:

- Mating pipe DN 100 (4"), schedule 80
- Device flange DN 100 (4"), schedule 40
- This installation position results in a diameter mismatch of 5 mm (0.2 in). If the correction function is not used, an additional measuring uncertainty of approx. 2 % o.r. must be expected.
- If the basic conditions are met and the feature is enabled, the additional measuring uncertainty is 1 % o.r.

 For detailed information on the parameters for diameter mismatch correction, see the Operating Instructions →  98

Accuracy of outputs

The outputs have the following base accuracy specifications.

Current output

Accuracy	±10 µA
-----------------	--------

Pulse/frequency output

o.r. = of reading

Accuracy	Max. ±100 ppm o.r.
-----------------	--------------------

Repeatability

o.r. = of reading

$$r = \left\{ \frac{100 \cdot D_i^3}{V} \right\}^{1/2}$$

A0034417

 13 [% o.r.]

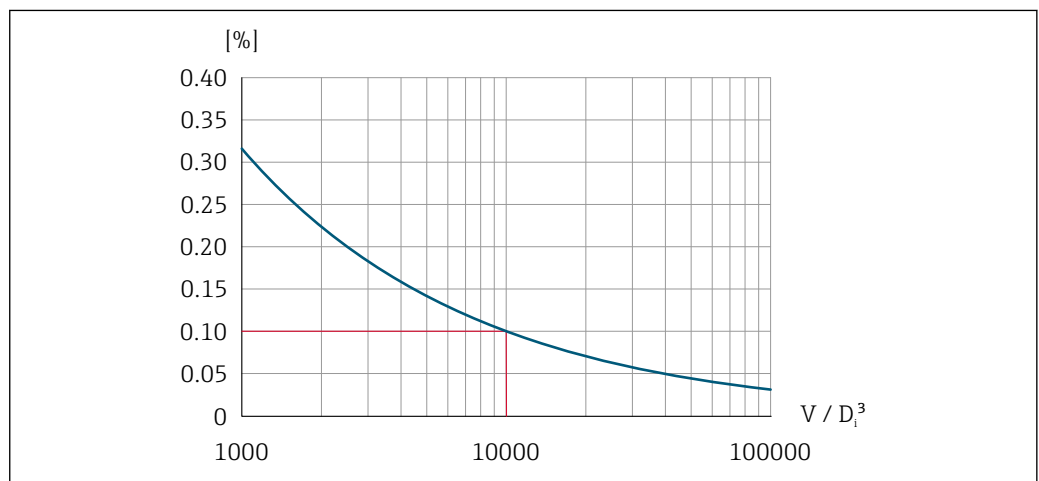

A0034414

 14 Repeatability = 0.1 % o.r. at a measured volume [m³] of $V = 1000 \cdot D_i^3$

The repeatability can be improved if the measured volume is increased. Repeatability is not a device characteristic but a statistical variable that is dependent on the boundary conditions indicated.

Response time

If all the configurable functions for filter times (flow damping, display damping, current output time constant, frequency output time constant, status output time constant) are set to 0, in the event of vortex frequencies of 10 Hz and higher a response time of $\max(T_v, 100 \text{ ms})$ can be expected.

In the event of measuring frequencies $< 10 \text{ Hz}$, the response time is $> 100 \text{ ms}$ and can be up to 10 s. T_v is the average vortex period duration of the flowing fluid.

Influence of ambient temperature

Current output

o.r. = of reading

Additional error, in relation to the span of 16 mA:

Temperature coefficient at zero point (4 mA)	0.02 %/10 K
Temperature coefficient with span (20 mA)	0.05 %/10 K

Pulse/frequency output

o.r. = of reading

Temperature coefficient	Max. $\pm 100 \text{ ppm o.r.}$
-------------------------	---------------------------------

Installation

Mounting location

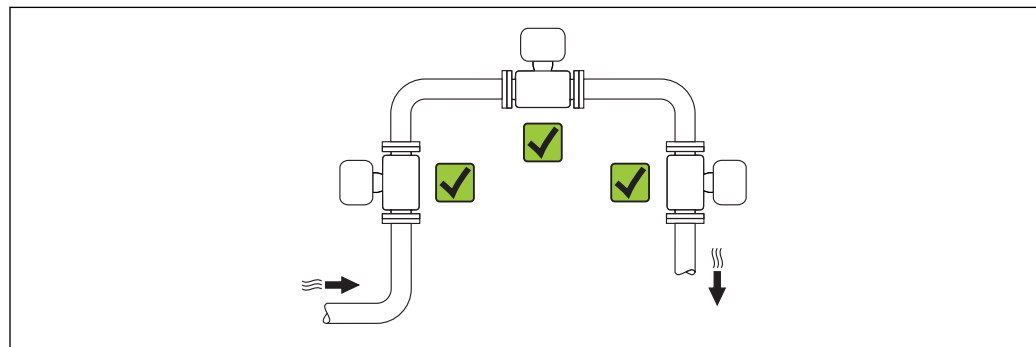

A0015543

Orientation

The direction of the arrow on the sensor nameplate helps you to install the sensor according to the flow direction (direction of medium flow through the piping).

Vortex meters require a fully developed flow profile as a prerequisite for correct volume flow measurement. Therefore, please note the following:

Orientation		Compact version	Remote version
A	Vertical orientation	✓✓ ¹⁾	✓✓
B	Horizontal orientation, transmitter head up	✓✓ ^{2) 3)}	✓✓

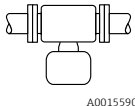
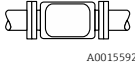
Orientation		Compact version	Remote version
C	Horizontal orientation, transmitter head down 	✓✓ ^{4) 5)}	✓✓
D	Horizontal orientation, transmitter head at side 	✓✓ ⁴⁾	✓✓

- 1) In the case of liquids, there should be upward flow in vertical pipes to avoid partial pipe filling (Fig. A). Disruption in flow measurement! In the case of vertical orientation and downward flowing liquid, the pipe always needs to be completely filled to ensure correct liquid flow measurement.
- 2) Danger of electronics overheating! If the fluid temperature is $\geq 200\text{ °C}$ (392 °F), orientation B is not permitted for the wafer version (Prowirl D) with nominal diameters of DN 100 (4") and DN 150 (6").
- 3) In the case of hot media (e.g. steam or fluid temperature (TM) $\geq 200\text{ °C}$ (392 °F): orientation C or D
- 4) In the case of very cold media (e.g. liquid nitrogen): orientation B or D
- 5) For "wet steam detection/measurement" option: orientation C

 The "mass" sensor version (integrated pressure/temperature measurement) is available only for measuring devices in the HART communication mode.

Pressure measuring cell

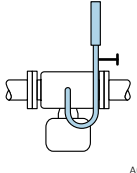
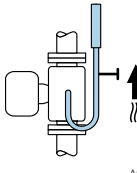
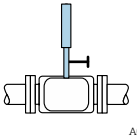
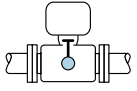
Steam pressure measurement		Option DA
E	<ul style="list-style-type: none"> ▪ With the transmitter installed at the bottom or at the side ▪ Protection against rising heat 	✓✓
F	<ul style="list-style-type: none"> ▪ Reduction in temperature to almost ambient temperature due to siphon ¹⁾ 	✓✓
Gas pressure measurement		Option DB
G	<ul style="list-style-type: none"> ▪ Pressure measuring cell with shut off device above tapping point ▪ Discharge of any condensate into the process 	✓✓
Liquid pressure measurement		Option DB
H	<ul style="list-style-type: none"> ▪ Device with shut off device at the same level as tapping point 	✓✓

1) Note max. permitted ambient temperature of transmitter → 50.

Minimum spacing and cable length

Order code for "Sensor version", option "mass" DA, DB

 The "mass" sensor version (integrated pressure/temperature measurement) is available only for measuring devices in the HART communication mode.

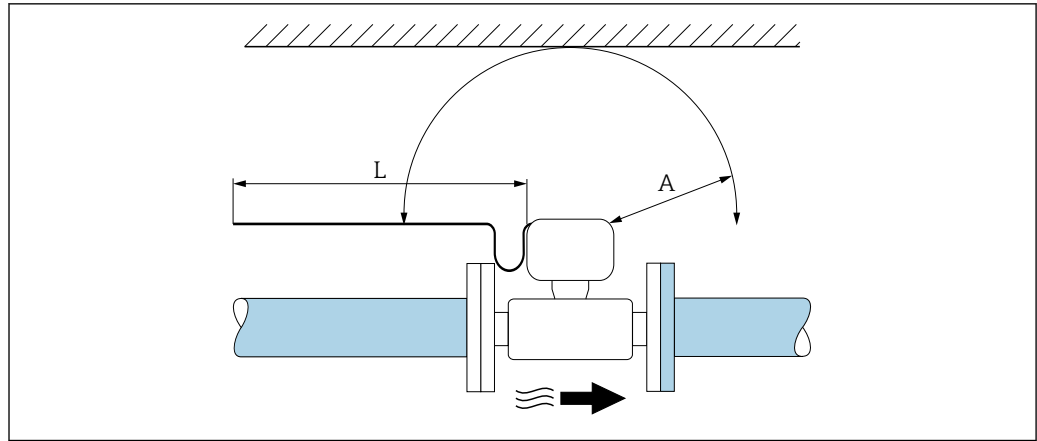

A0019211

- A* Minimum spacing in all directions
L Required cable length

The following dimensions must be observed to guarantee problem-free access to the device for service purposes:

- $A = 100 \text{ mm}$ (3.94 in)
- $L = L + 150 \text{ mm}$ (5.91 in)

Inlet and outlet runs

To attain the specified level of accuracy of the measuring device, the inlet and outlet runs mentioned below must be maintained at the very minimum.

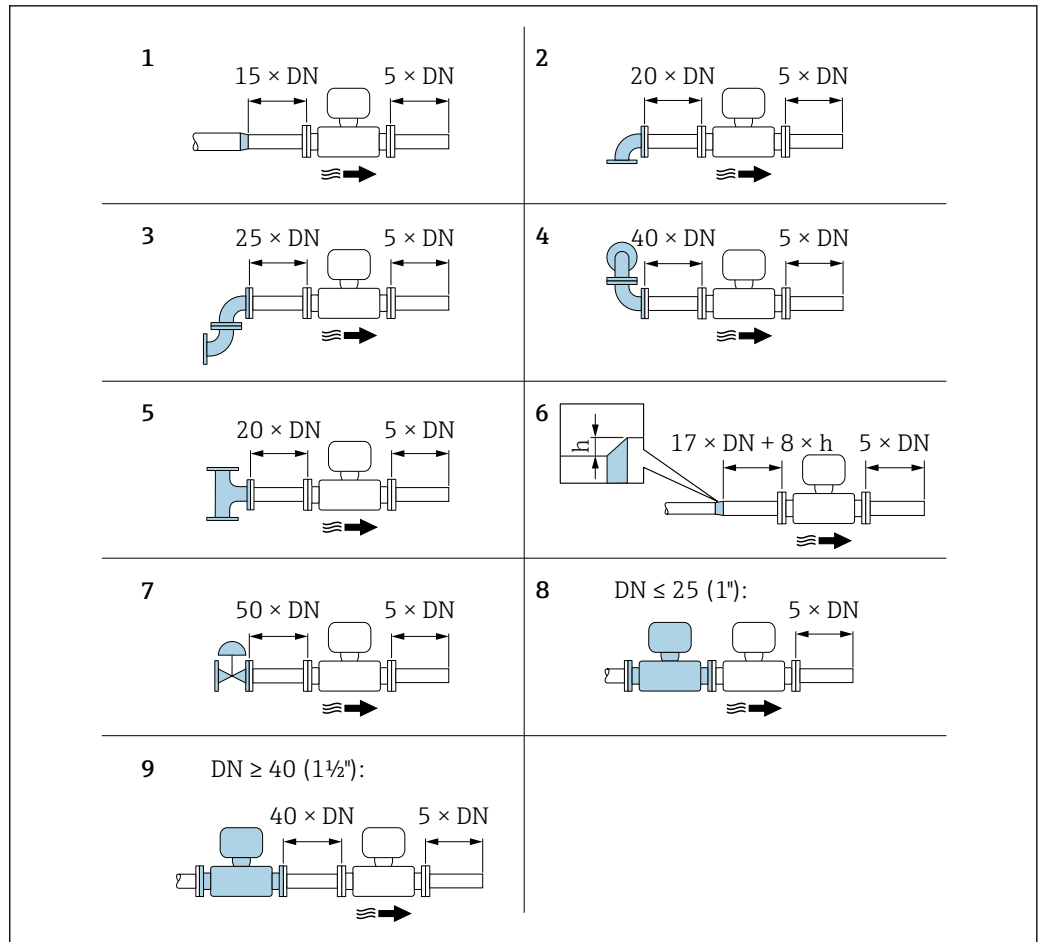

A0019189

15 Minimum inlet and outlet runs with various flow obstructions

h Difference in expansion

1 Reduction by one nominal diameter size

2 Single elbow (90° elbow)

3 Double elbow (2 × 90° elbows, opposite)

4 Double elbow 3D (2 × 90° elbows, opposite, not on one plane)

5 T-piece

6 Expansion

7 Control valve

8 Two measuring devices in a row where $DN \leq 25$ (1''): directly flange on flange

9 Two measuring devices in a row where $DN \geq 40$ (1½''): for spacing, see graphic

- i** If there are several flow disturbances present, the longest specified inlet run must be maintained.
- If the required inlet runs cannot be observed, it is possible to install a specially designed flow conditioner → 47.

i The **inlet run correction** function:

- Makes it possible to shorten the inlet run to a minimum length of $10 \times DN$ in the event of flow obstructions 1 to 4. An additional measuring uncertainty of $\pm 0.5\%$ o.r. occurs here.
- Cannot be combined with the **wet steam detection/measurement** → 94 application package. If wet steam detection/measurement is used, the corresponding inlet runs must be taken into consideration. It is not possible to use a flow conditioner for wet steam.

Flow conditioner

If the inlet runs cannot be observed, the use of a flow conditioner is recommended.

The flow conditioner is fitted between two pipe flanges and centered by the mounting bolts. Generally this reduces the inlet run needed to $10 \times DN$ with full accuracy.

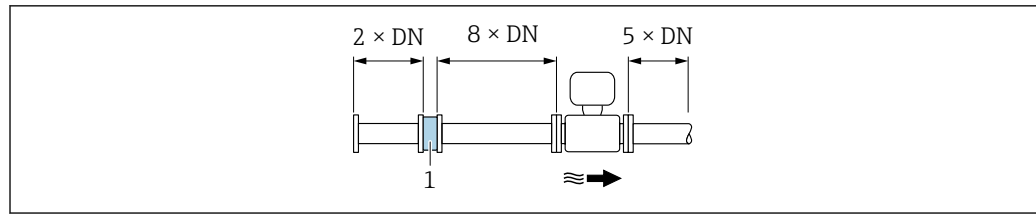

1 Flow conditioner

The pressure loss for flow conditioners is calculated as follows: $\Delta p \text{ [mbar]} = 0.0085 \cdot \rho \text{ [kg/m}^3\text{]} \cdot v^2 \text{ [m/s]}$

Example for steam

$p = 10 \text{ bar abs.}$

$t = 240 \text{ }^\circ\text{C} \rightarrow \rho = 4.39 \text{ kg/m}^3$

$v = 40 \text{ m/s}$

$\Delta p = 0.0085 \cdot 4.39 \cdot 40^2 = 59.7 \text{ mbar}$

Example for H₂O condensate (80 °C)

$\rho = 965 \text{ kg/m}^3$

$v = 2.5 \text{ m/s}$

$\Delta p = 0.0085 \cdot 965 \cdot 2.5^2 = 51.3 \text{ mbar}$

ρ : density of the process medium

v : average flow velocity

abs. = absolute

i A specially designed flow conditioner is available from Endress+Hauser: → 65

Outlet runs when installing external devices

If installing an external device, observe the specified distance.

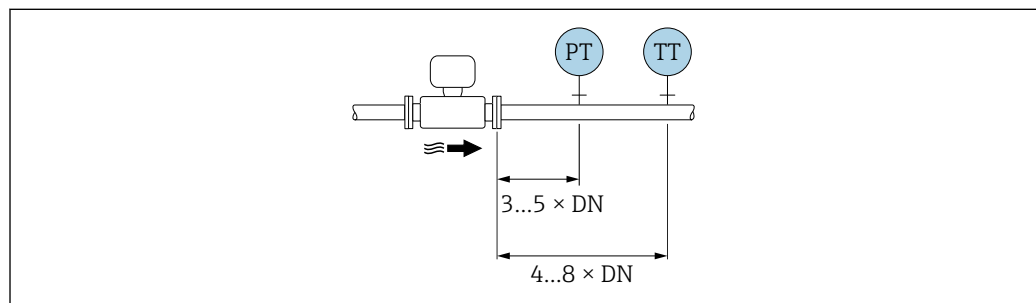

PT Pressure

TT Temperature device

Length of connecting cable

To ensure correct measuring results when using the remote version,

- observe the maximum permitted cable length: $L_{\text{max}} = 30 \text{ m (90 ft)}$.
- The value for the cable length must be calculated if the cable cross-section differs from the specification.

For detailed information about calculating the length of the connecting cable, refer to the Operating Instructions for the device on the CD-ROM provided

Mounting the transmitter housing

Wall mounting

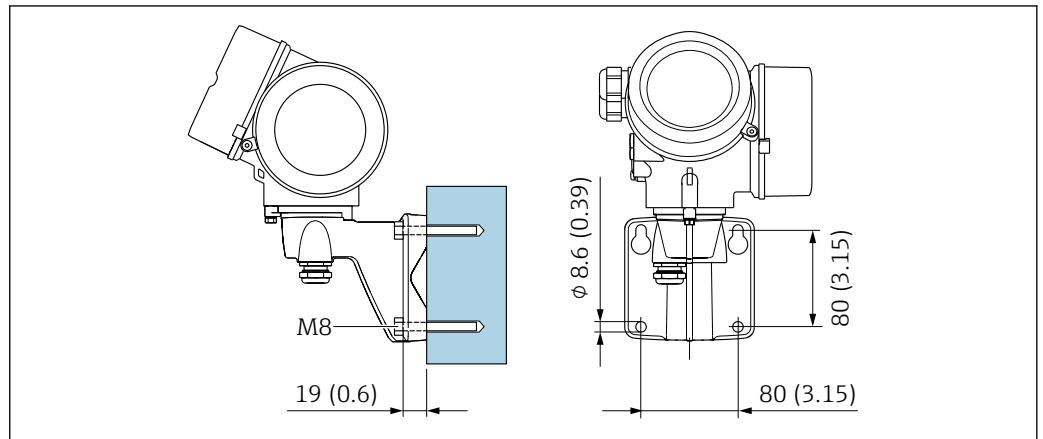

16 mm (in)

Post mounting

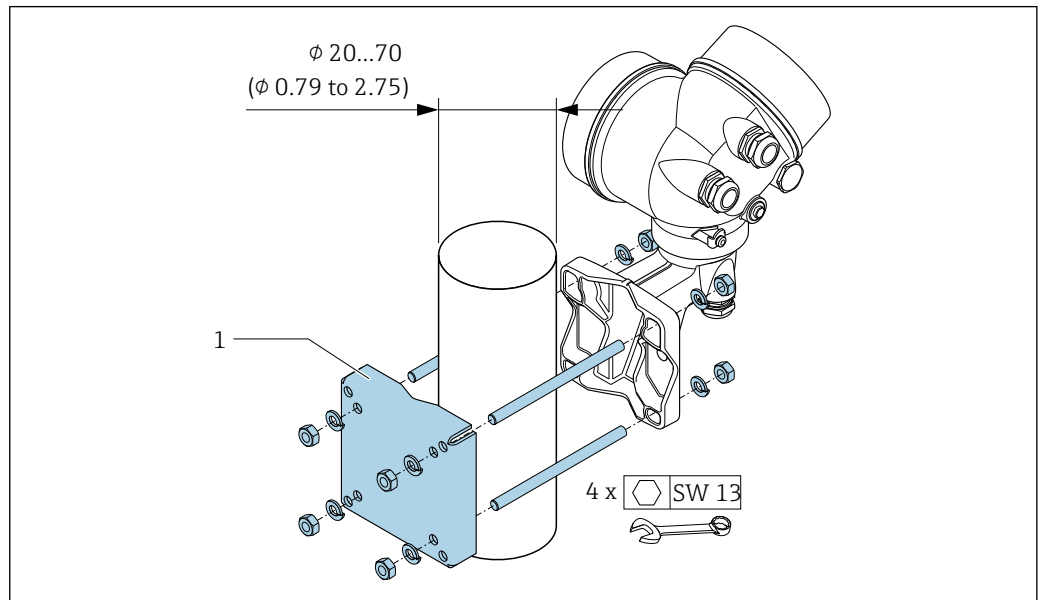

17 mm (in)

Special mounting instructions

Installation for delta heat measurements

- Order code for "Sensor version", option CA "mass; 316L; 316L (integrated temperature measurement), -200 to +400 °C (-328 to +750 °F)"
- Order code for "Sensor version", option CB "mass; Alloy C22; 316L (integrated temperature measurement), -200 to +400 °C (-328 to +750 °F)"
- Order code for "Sensor version", option CC "mass; Alloy C22; Alloy C22 (integrated temperature measurement), -40 to +260 °C (-40 to +500 °F)"
- Order code for "Sensor version", option DA "mass steam; 316L; 316L (integrated pressure/temperature measurement), -200 to +400 °C (-328 to +750 °F)"
- Order code for "Sensor version", option DB "mass gas/liquid; 316L; 316L (integrated pressure/temperature measurement), -40 to +100 °C (-40 to +212 °F)"

The second temperature measurement is taken using a separate temperature sensor. The measuring device reads in this value via a communication interface.

- In the case of saturated steam delta heat measurements, the measuring device must be installed on the steam side.
- In the case of water delta heat measurements, the device can be installed on the cold or warm side.

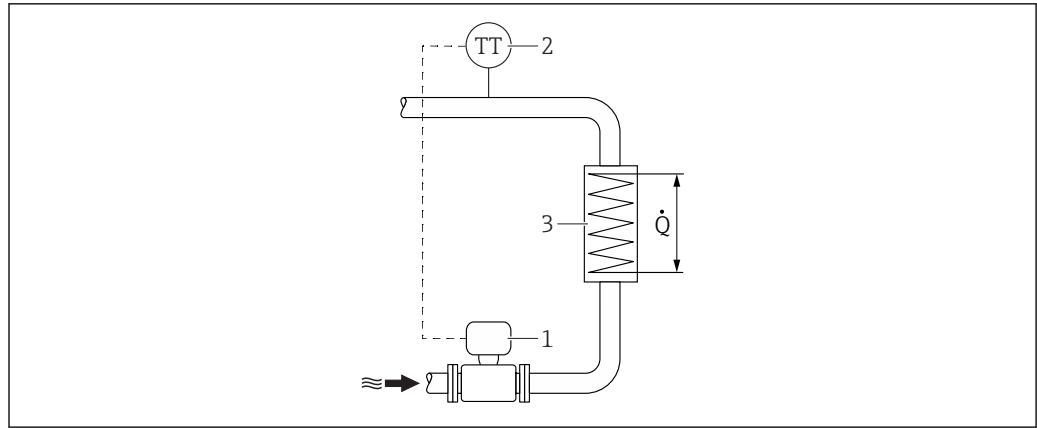

A0019209

18 Layout for delta heat measurement of saturated steam and water

- 1 Measuring device
 2 Temperature sensor
 3 Heat exchanger
 Q Heat flow

Protective cover

Observe the following minimum head clearance: 222 mm (8.74 in)

 For information on the weather protection cover, see →  95

Environment

Ambient temperature range

Compact version

Measuring device	Non-hazardous area:	-40 to +80 °C (-40 to +176 °F) ¹⁾
	Ex i, Ex nA, Ex ec:	-40 to +70 °C (-40 to +158 °F) ¹⁾
	Ex d, XP:	-40 to +60 °C (-40 to +140 °F) ¹⁾
	Ex d, Ex ia:	-40 to +60 °C (-40 to +140 °F) ¹⁾
Local display		-40 to +70 °C (-40 to +158 °F) ^{2) 1)}

- 1) Additionally available as order code for "Test, certificate", option JN "Transmitter ambient temperature - 50 °C (-58 °F)".
 2) At temperatures < -20 °C (-4 °F), depending on the physical characteristics involved, it may no longer be possible to read the liquid crystal display.



Remote version

Transmitter	Non-hazardous area:	-40 to +80 °C (-40 to +176 °F) ¹⁾
	Ex i, Ex nA, Ex ec:	-40 to +80 °C (-40 to +176 °F) ¹⁾
	Ex d:	-40 to +60 °C (-40 to +140 °F) ¹⁾
	Ex d, Ex ia:	-40 to +60 °C (-40 to +140 °F) ¹⁾
Sensor	Non-hazardous area:	-40 to +85 °C (-40 to +185 °F) ¹⁾
	Ex i, Ex nA, Ex ec:	-40 to +85 °C (-40 to +185 °F) ¹⁾
	Ex d:	-40 to +85 °C (-40 to +185 °F) ¹⁾

	Ex d, Ex ia:	-40 to +85 °C (-40 to +185 °F) ¹⁾
Local display		-40 to +70 °C (-40 to +158 °F) ^{2) 1)}

- 1) Additionally available as order code for "Test, certificate", option JN "Transmitter ambient temperature - 50 °C (-58 °F)".
- 2) At temperatures < -20 °C (-4 °F), depending on the physical characteristics involved, it may no longer be possible to read the liquid crystal display.

- ▶ If operating outdoors:
Avoid direct sunlight, particularly in warm climatic regions.

 You can order a weather protection cover from Endress+Hauser. →  95.

Storage temperature All components apart from the display modules:
-50 to +80 °C (-58 to +176 °F)

Display modules

All components apart from the display modules:
-50 to +80 °C (-58 to +176 °F)

Remote display FHX50:
-50 to +80 °C (-58 to +176 °F)

Climate class DIN EN 60068-2-38 (test Z/AD)

Degree of protection

Transmitter

- As standard: IP66/67, type 4X enclosure
- When housing is open: IP20, type 1 enclosure
- Display module: IP20, type 1 enclosure

Sensor
IP66/67, type 4X enclosure

Connector
IP67, only in screwed situation

Vibration resistance **Vibration, sinusoidal according to IEC 60068-2-6**

- Order code for "Housing", option C "GT20 two-chamber, aluminum, coated, compact", J "GT20 two-chamber, aluminum, coated, remote", K "GT18 two-chamber, 316L, remote"
 - 2 to 8.4 Hz, 7.5 mm peak
 - 8.4 to 500 Hz, 2 g peak
- Order code for "Housing", option B "GT18 two-chamber, 316L, compact"
 - 2 to 8.4 Hz, 3.5 mm peak
 - 8.4 to 500 Hz, 1 g peak
- Order code for "Sensor version; DSC sensor; measuring tube", option DA "mass steam; 316L; 316L (integrated pressure/temperature measurement)" or option DB "mass gas/liquid; 316L; 316L (integrated pressure/temperature measurement)"
 - 2 to 8.4 Hz, 3.5 mm peak
 - 8.4 to 500 Hz, 1 g peak

Vibration broad-band random, according to IEC 60068-2-64

- Order code for "Housing", option C "GT20 two-chamber, aluminum, coated, compact", J "GT20 two-chamber, aluminum, coated, remote", K "GT18 two-chamber, 316L, remote"
 - 10 to 200 Hz, 0.01 g²/Hz
 - 200 to 500 Hz, 0.003 g²/Hz
 - Total 2.7 g rms
- Order code for "Housing", option B "GT18 two-chamber, 316L, compact"
 - 10 to 200 Hz, 0.003 g²/Hz
 - 200 to 500 Hz, 0.001 g²/Hz
 - Total 1.54 g rms
- Order code for "Sensor version"; DSC sensor; measuring tube", option DA "mass steam; 316L; 316L (integrated pressure/temperature measurement)" or option DB "mass gas/liquid; 316L; 316L (integrated pressure/temperature measurement)"
 - 2 to 8.4 Hz, 3.5 mm peak
 - 8.4 to 500 Hz, 1 g peak

Shock resistance**Shock, half-sine according to IEC 60068-2-27**

- Order code for "Housing", option C "GT20 two-chamber, aluminum, coated, compact", J "GT20 two-chamber, aluminum, coated, remote", K "GT18 two-chamber, 316L, remote"
 - 6 ms, 50 g
- Order code for "Housing", option B "GT18 two-chamber, 316L, compact"
 - 6 ms, 30 g

Impact resistance

Rough handling shocks according to IEC 60068-2-31

Electromagnetic compatibility (EMC)

As per IEC/EN 61326 and NAMUR Recommendation 21 (NE 21)



Details are provided in the Declaration of Conformity.

Process

Medium temperature range*DSC sensor*¹⁾

Order code for "Sensor version; DSC sensor; measuring tube"		
Option	Description	Medium temperature range
AA	Volume; 316L; 316L	-40 to +260 °C (-40 to +500 °F), stainless steel
AB	Volume; Alloy C22; 316L	
AC	Volume; Alloy C22; Alloy C22	-40 to +260 °C (-40 to +500 °F), stainless steel
BA	Volume high-temperature; 316L; 316L	-200 to +400 °C (-328 to +752 °F), stainless steel
BB	Volume high-temperature; Alloy C22; 316L	
CA	Mass; 316L; 316L	-200 to +400 °C (-328 to +752 °F), stainless steel
CB	Mass; Alloy C22; 316L	
CC	Mass; Alloy C22; Alloy C22	-40 to +260 °C (-40 to +500 °F), stainless steel

1) Capacitance sensor

Order code for "Sensor version; DSC sensor; measuring tube"		
Option	Description	Medium temperature range
 The "mass" sensor version (integrated pressure/temperature measurement) is available only for measuring devices in the HART communication mode.		
DA	Mass steam; 316L; 316L	-200 to +400 °C (-328 to +752 °F), stainless steel ^{1) 2)}
DB	Mass gas/liquid; 316L; 316L	-40 to +100 °C (-40 to +212 °F), stainless steel ²⁾

- 1) Siphon enables use for extended temperature range (up to +400 °C (+752 °F)).
- 2) In steam applications, in conjunction with the siphon, the steam temperature may be higher (up to +400 °C (+752 °F)) than the permitted temperature of the pressure measuring cell. Without a siphon, the gas temperature is restricted due to the maximum permitted temperature of the pressure measuring cell. This applies regardless of whether or not a stop cock is present.

Pressure measuring cell

Order code for "Pressure component"		
Option	Description	Medium temperature range
B	Pressure measuring cell 2bar/29psi abs	-40 to +100 °C (-40 to +212 °F)
C	Pressure measuring cell 4bar/58psi abs	
D	Pressure measuring cell 10bar/145psi abs	
E	Pressure measuring cell 40bar/580psi abs	
F	Pressure measuring cell 100bar/1450psi abs	



Seals

Order code for "DSC sensor seal"		
Option	Description	Medium temperature range
A	Graphite (standard)	-200 to +400 °C (-328 to +752 °F)
B	Viton	-15 to +175 °C (+5 to +347 °F)
C	Gylon	-200 to +260 °C (-328 to +500 °F)
D	Kalrez	-20 to +275 °C (-4 to +527 °F)

Pressure-temperature ratings

The following pressure/temperature diagrams apply to all pressure-bearing parts of the device and not just the process connection. The diagrams show the maximum permissible medium pressure depending on the specific medium temperature.

The pressure-temperature rating for the specific measuring device is programmed into the software. If values exceed the curve range a warning is displayed. Depending on the system configuration and sensor version, the pressure and temperature are determined by entering, reading in or calculating values.

 Integral mass vortex: The permitted pressure for the measuring device can be less than indicated in this section, depending on the selected pressure measuring cell. →  56

Flange connection: flange according to EN 1092-1 (DIN 2501)

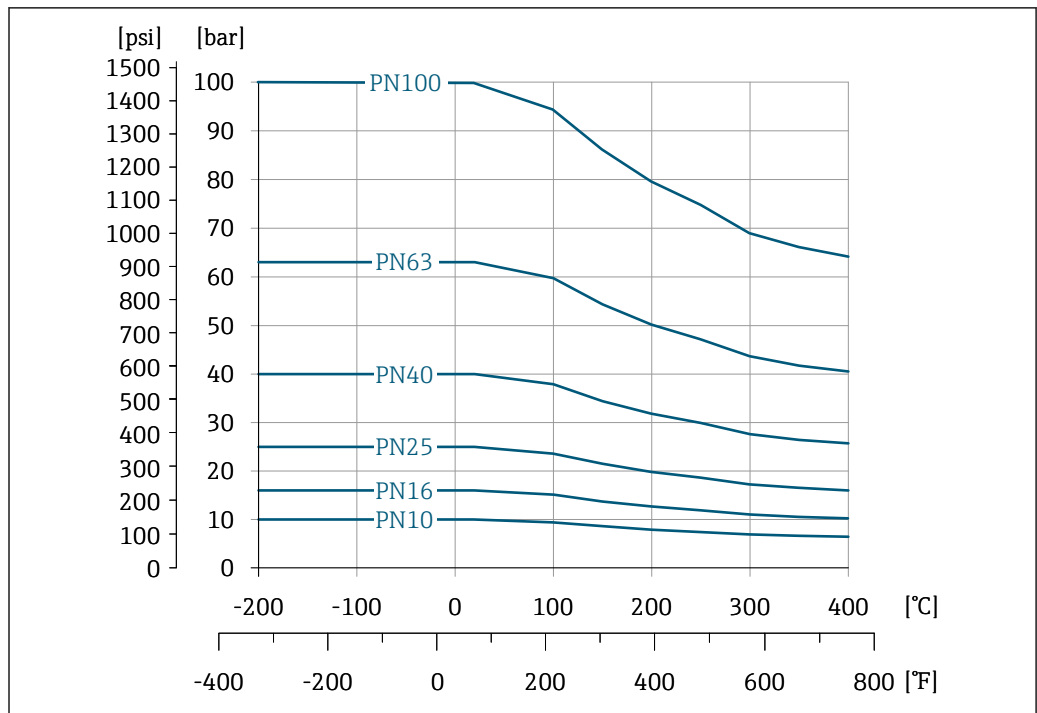

A0034052-EN

19 Flange connection material: stainless steel, multiple certifications, 1.4404/F316/F316L

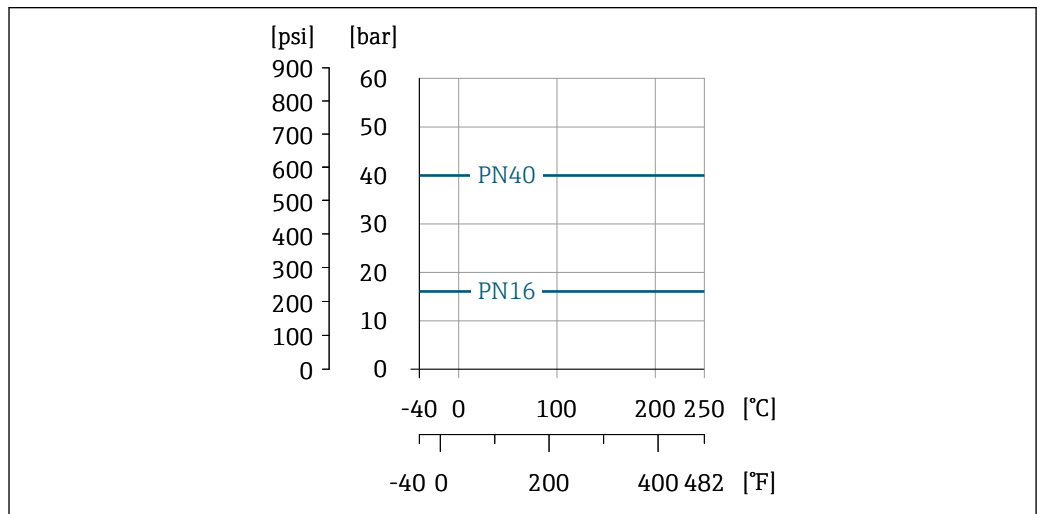

A0034045-EN

20 Flange connection material: cast, CX2MW similar to Alloy C22/2.4602

Flange connection: flange according to ASME B16.5

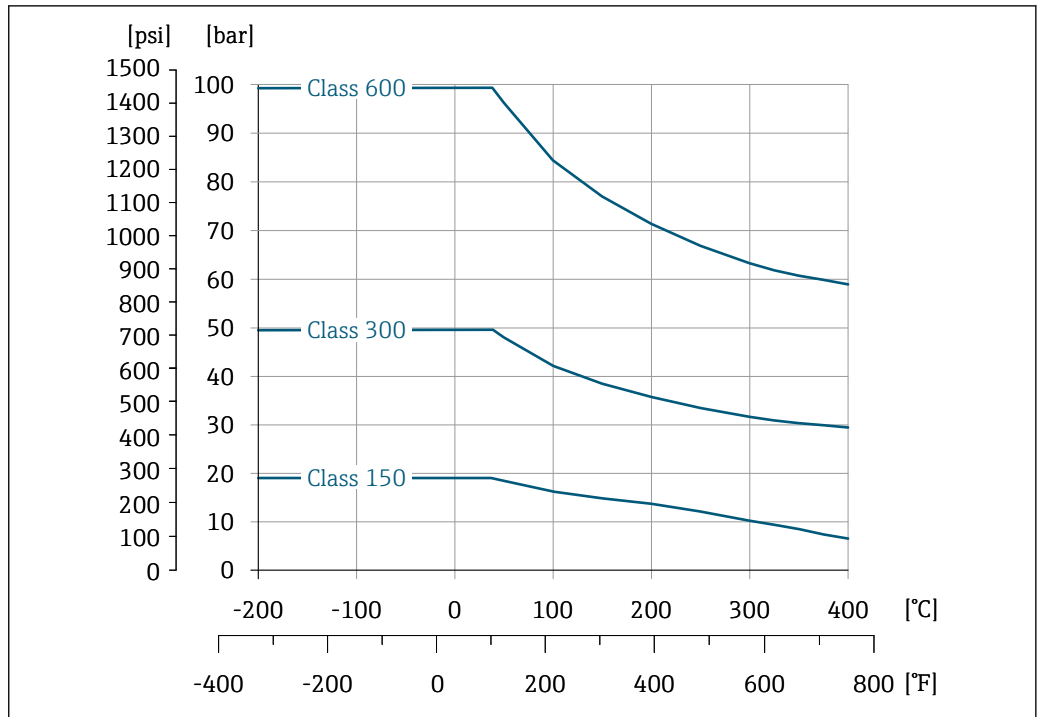

A0034051-EN

21 Flange connection material: stainless steel, multiple certifications, 1.4404/F316/F316L

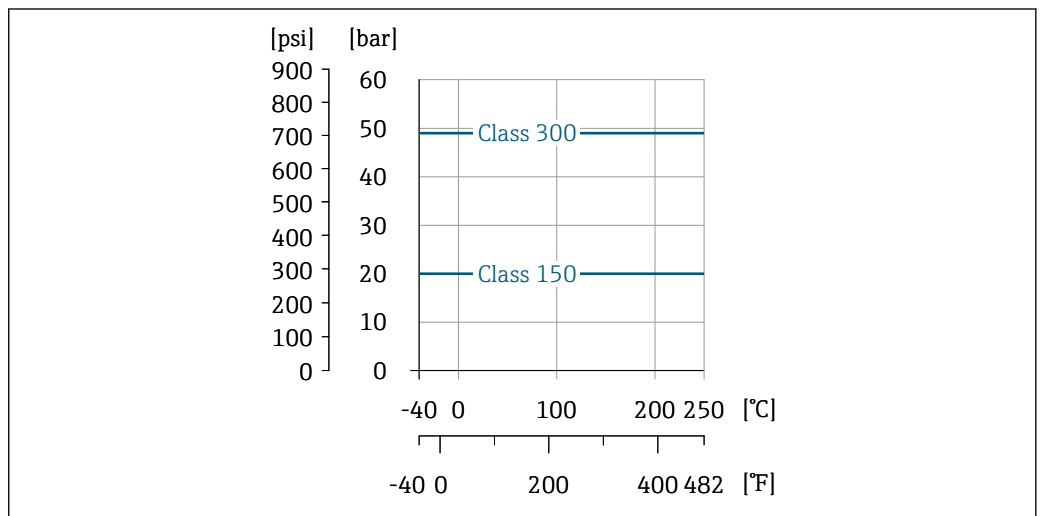

A0034046-EN

22 Flange connection material: cast, CX2MW similar to Alloy C22/2.4602

Flange connection: flange according to JIS B2220

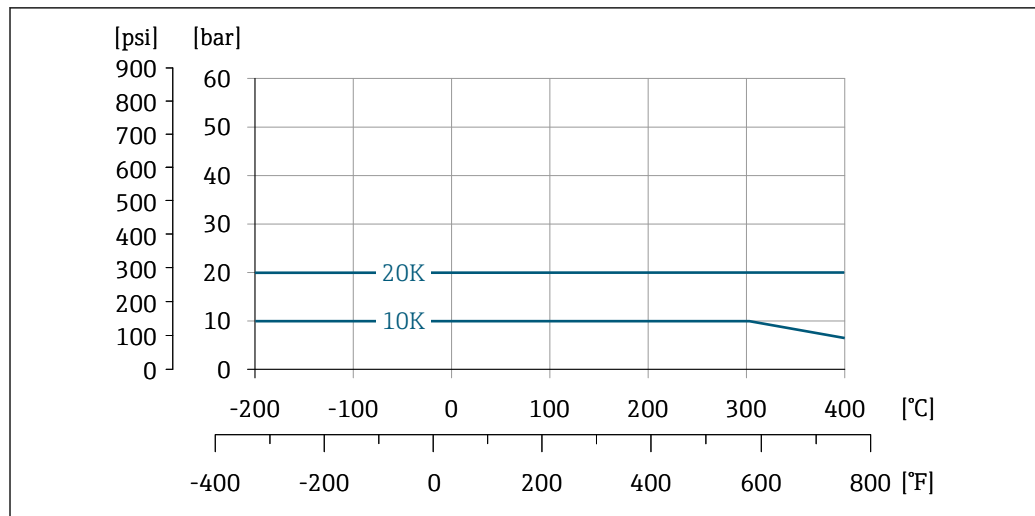

A0034043-EN

23 Flange connection material: stainless steel, multiple certifications, 1.4404/F316/F316L

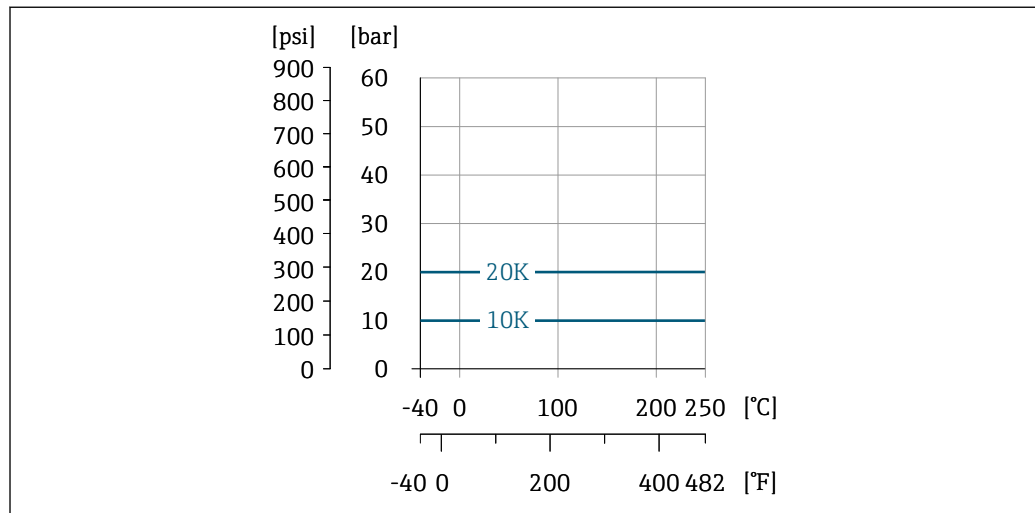

A0034044-EN

24 Flange connection material: cast, CX2MW similar to Alloy C22/2.4602

Nominal pressure of sensor

The following overpressure resistance values apply to the sensor shaft in the event of a membrane rupture:

Sensor version; DSC sensor; measuring tube	Overpressure, sensor shaft in [bar a]
Volume	200
Volume high-temperature	200
Mass (integrated temperature measurement)	200
Mass steam (integrated pressure/temperature measurement) Mass gas/liquid (integrated pressure/temperature measurement)	200

Pressure specifications

i The "mass" sensor version (integrated pressure/temperature measurement) is available only for measuring devices in the HART communication mode.

The OPL (over pressure limit = sensor overload limit) for the measuring device depends on the lowest-rated element, with regard to pressure, of the selected components, i.e. the process connection has to be taken into consideration in addition to the measuring cell. Also observe pressure-temperature dependency. For the appropriate standards and further information → 41. The OPL may only be applied for a limited period of time.

The MWP (maximum working pressure) for the sensors depends on the lowest-rated element, with regard to pressure, of the selected components, i.e. the process connection has to be taken into consideration in addition to the measuring cell. Also observe pressure-temperature dependency. For the appropriate standards and further information → 41. The MWP may be applied at the device for an unlimited period. The MWP can also be found on the nameplate.

⚠ WARNING

The maximum pressure for the measuring device depends on the lowest-rated element with regard to pressure.

- ▶ Note specifications regarding pressure range → 41.
- ▶ The Pressure Equipment Directive (2014/68/EU) uses the abbreviation "PS". The abbreviation "PS" corresponds to the MWP of the device.
- ▶ MWP: The MWP is indicated on the nameplate. This value refers to a reference temperature of +20 °C (+68°F) and may be applied to the device for an unlimited time. Note temperature dependence of MWP.
- ▶ OPL: The test pressure corresponds to the over pressure limit of the sensor and may be applied only temporarily to ensure that the measurement is within the specifications and no permanent damage occurs. In the case of sensor range and process connection combinations where the OPL of the process connection is less than the nominal value of the sensor, the device is set at the factory, at the very maximum, to the OPL value of the process connection. If using the entire sensor range, select a process connection with a higher OPL value.

Sensor	Maximum sensor measuring range		MWP	OPL
	Lower (LRL)	Upper (URL)		
	[bar (psi)]	[bar (psi)]	[bar (psi)]	[bar (psi)]
2 bar (30 psi)	0 (0)	+2 (+30)	6.7 (100.5)	10 (150)
4 bar (60 psi)	0 (0)	+4 (+60)	10.7 (160.5)	16 (240)
10 bar (150 psi)	0 (0)	+10 (+150)	25 (375)	40 (600)
40 bar (600 psi)	0 (0)	+40 (+600)	100 (1 500)	160 (2 400)
100 bar (1 500 psi)	0 (0)	+100 (+1 500)	100 (1 500)	160 (2 400)

Pressure loss

For a precise calculation, use the Applicator → 97.

Thermal insulation

For optimum temperature measurement and mass calculation, heat transfer at the sensor must be avoided for some fluids. This can be ensured by installing thermal insulation. A wide range of materials can be used for the required insulation.

This applies for:

- Compact version
- Remote sensor version

The maximum insulation height permitted is illustrated in the diagram:

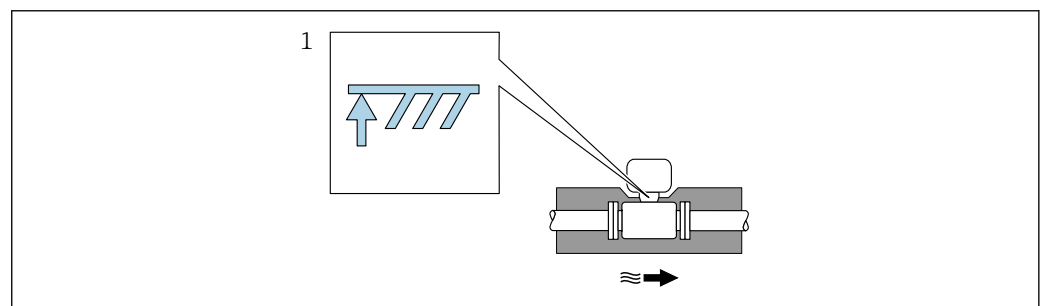

1 Maximum insulation height

- ▶ When insulating, ensure that a sufficiently large area of the housing support remains exposed. The uncovered part serves as a radiator and protects the electronics from overheating and excessive cooling.

Mechanical construction

Dimensions in SI units

Compact version

Order code for "Housing", option B "GT18, two-chamber, 316L, compact"; option C "GT20, two-chamber, aluminum, coated, compact"

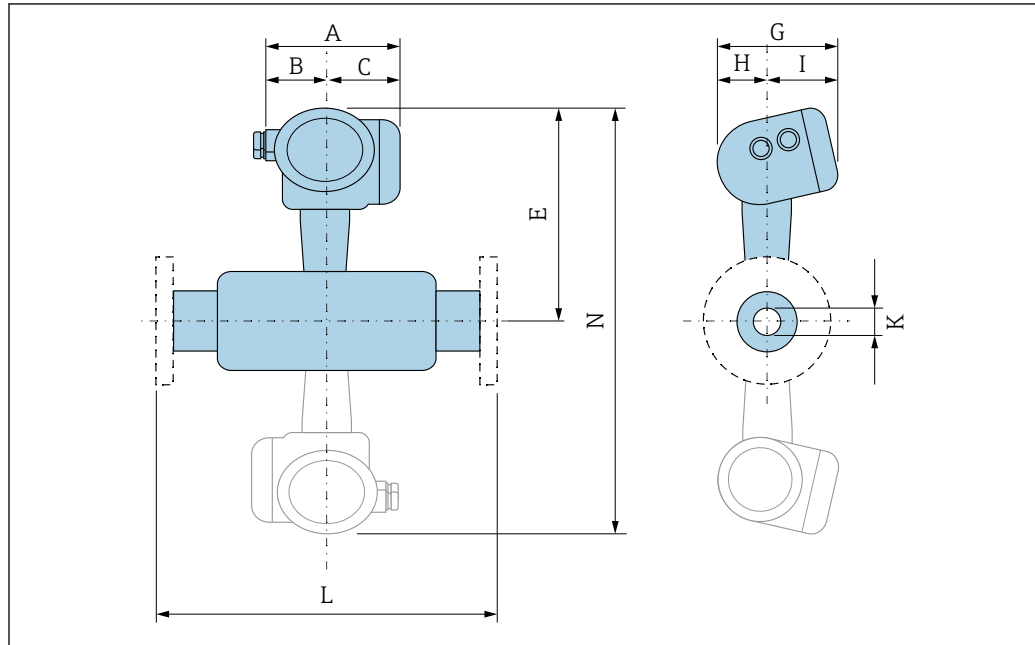

A0033794

25 *Grayed out: Dualsens version*

DN	A ¹⁾	B	C ¹⁾	E ^{2) 3)}	G	H	I ⁴⁾	K (D _i)	L	N ^{5) 6)}
[mm]	[mm]	[mm]	[mm]	[mm]	[mm]	[mm]	[mm]	[mm]	[mm]	[mm]
15	140.2	51.7	88.5	252	159.9	58.2	101.7	13.9	⁷⁾	⁸⁾
25	140.2	51.7	88.5	258	159.9	58.2	101.7	24.3	⁷⁾	⁸⁾
40	140.2	51.7	88.5	266	159.9	58.2	101.7	38.1	⁷⁾	531
50	140.2	51.7	88.5	272	159.9	58.2	101.7	49.2	⁷⁾	543
80	140.2	51.7	88.5	286	159.9	58.2	101.7	73.7	⁷⁾	571
100	140.2	51.7	88.5	300	159.9	58.2	101.7	97.0	⁷⁾	599
150	140.2	51.7	88.5	325	159.9	58.2	101.7	146.3	⁷⁾	650
200	140.2	51.7	88.5	348	159.9	58.2	101.7	193.7	⁷⁾	695
250	140.2	51.7	88.5	375	159.9	58.2	101.7	242.8	⁷⁾	750
300	140.2	51.7	88.5	397	159.9	58.2	101.7	288.9	⁷⁾	795

- 1) For version with overvoltage protection: values + 8 mm
- 2) For version without local display: values - 10 mm
- 3) For high-temperature/low-temperature version: values + 29 mm
- 4) For version without local display: values - 7 mm
- 5) For version without local display: values - 20 mm
- 6) For high-temperature/low-temperature version: values + 58 mm
- 7) Dependent on respective flange connection
- 8) Not available as a Dualsens version

Transmitter remote version

Order code for "Housing", option J "GT20 two-chamber, aluminum, coated, remote"; option K "GT18 two-chamber, 316L, remote"

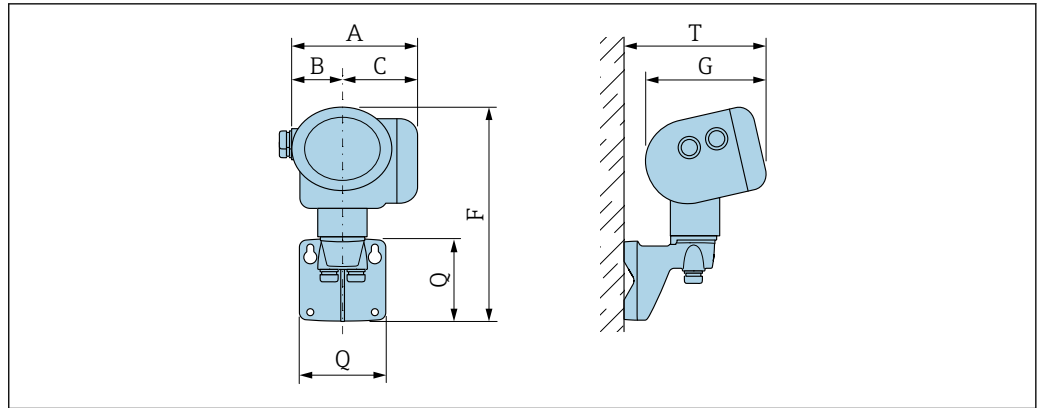

A0033796

A ¹⁾ [mm]	B [mm]	C ¹⁾ [mm]	F ²⁾ [mm]	G ³⁾ [mm]	Q [mm]	T ³⁾ [mm]
140.2	51.7	88.5	254	159.9	107	191

- 1) For version with overvoltage protection: value + 8 mm
- 2) For version without local display: value - 10 mm
- 3) For version without local display: value - 7 mm

Sensor remote version

Order code for "Housing", option J "GT20 two-chamber, aluminum, coated, remote"; option K "GT18 two-chamber, 316L, remote"

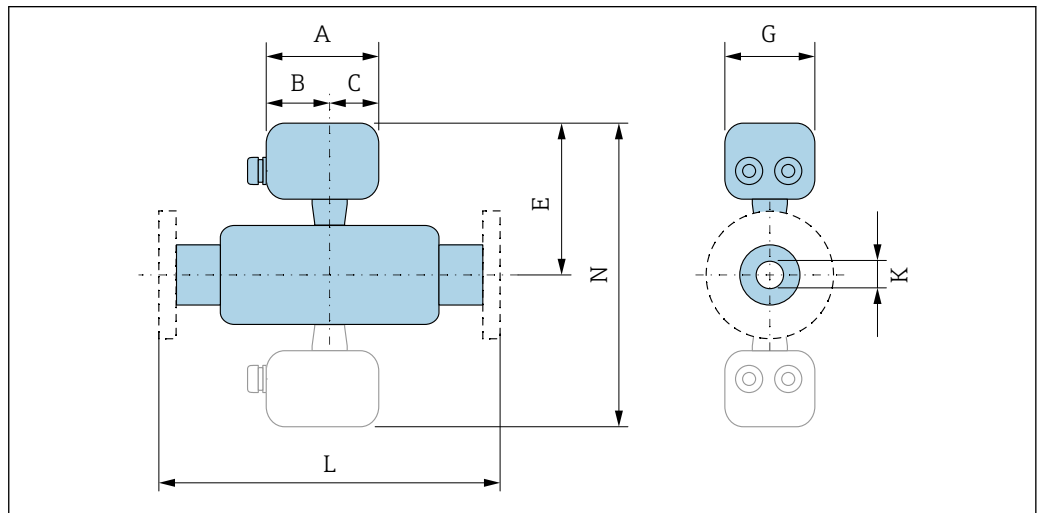

A0033797

26 Grayed out: Dualsens version

DN [mm]	A [mm]	B [mm]	C [mm]	E ¹⁾ [mm]	G [mm]	K (D _i) [mm]	L [mm]	N ²⁾ [mm]
15	107.3	60.0	47.3	225	94.5	13.9	³⁾	⁴⁾
25	107.3	60.0	47.3	231	94.5	24.3	³⁾	⁴⁾
40	107.3	60.0	47.3	239	94.5	38.1	³⁾	477
50	107.3	60.0	47.3	245	94.5	49.2	³⁾	489
80	107.3	60.0	47.3	259	94.5	73.7	³⁾	517
100	107.3	60.0	47.3	273	94.5	97.0	³⁾	545
150	107.3	60.0	47.3	298	94.5	146.3	³⁾	596

DN [mm]	A [mm]	B [mm]	C [mm]	E ¹⁾ [mm]	G [mm]	K (D _i) [mm]	L [mm]	N ²⁾ [mm]
200	107.3	60.0	47.3	321	94.5	193.7	³⁾	641
250	107.3	60.0	47.3	348	94.5	242.8	³⁾	696
300	107.3	60.0	47.3	370	94.5	288.9	³⁾	741

- 1) For high-temperature/low-temperature version: values +29 mm
- 2) For high-temperature/low-temperature version: values + 58 mm
- 3) Dependent on respective flange connection
- 4) Not available as a Dualsens version

Flange connections

Flange

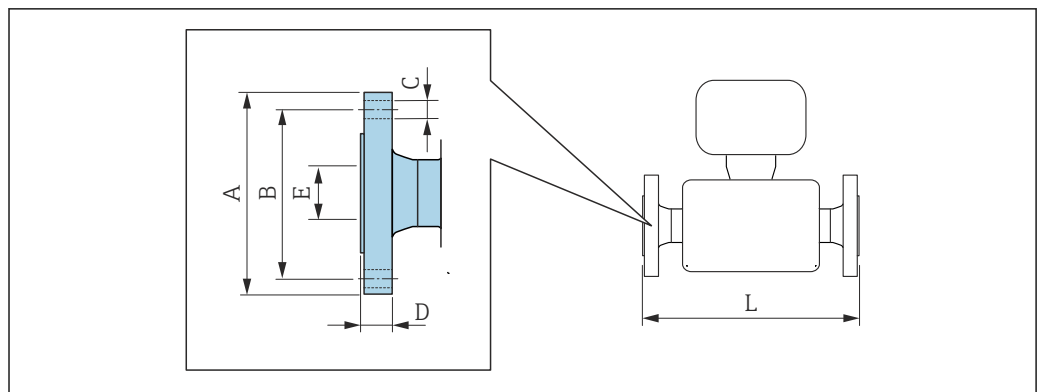

A0015621

- i** Length tolerance for dimension L in mm:
 DN ≤ 100: +1.5 to -2.0 mm
 DN ≥ 150: ±3.5 mm

Flange connection dimensions according to ASME B16.5: Class 150, Schedule 40/80						
<ul style="list-style-type: none"> ▪ Triple-certified material, 1.4404/F316/F316L ▪ Alloy C22/2.4602 (DN 15 to 150) 						
Order code for "Process connection", option AAS/AFS						
DN [mm]	A [mm]	B [mm]	C [mm]	D [mm]	E [mm]	L [mm]
15	88.9	60.5	4 × Ø15.7	11.2	13.9	200
25	107.9	79.2	4 × Ø15.7	15.7	24.3	200
40	127.0	98.6	4 × Ø15.7	17.5	38.1	200
50	152.4	120.7	4 × Ø19.1	19.1	49.2	200
80	190.5	152.4	4 × Ø19.1	23.9	73.7	200
100	228.6	190.5	8 × Ø 19.1	24.5	97	250
150	279.4	241.3	8 × Ø 22.4	25.4	146.3	300
200	345	298.5	8 × Ø 22.3	29	193.7	329
250	405	362	12 × Ø25.4	30.6	242.8	348
300	485	431.8	12 × Ø25.4	32.2	288.9	418
Raised face according to ASME B16.5: Ra 3.2 to 6.3 µm						

Flange connection dimensions according to ASME B16.5: Class 300, Schedule 40/80

- Triple-certified material, 1.4404/F316/F316L
- Alloy C22/2.4602 (DN 15 to 150)

Order code for "Process connection", option ABS/AGS

DN [mm]	A [mm]	B [mm]	C [mm]	D [mm]	E [mm]	L [mm]
15	95.0	66.5	4 × Ø15.7	14.2	13.9	200
25	123.8	88.9	4 × Ø19.1	19.1	24.3	200
40	155.6	114.3	4 × Ø22.4	20.6	38.1	200
50	165.0	127.0	8 × Ø 19.1	22.4	49.2	200
80	210.0	168.1	8 × Ø 22.4	28.4	73.7	200
100	254.0	200.2	8 × Ø 22.4	31.8	97	250
150	317.5	269.7	12 × Ø22.4	36.6	146.3	300
200	380	330.2	12 × Ø25.4	41.7	193.7	350
250	445	387.4	16 × Ø28.6	48.1	242.8	380
300	520	450.8	16 × Ø31.8	51.3	288.9	450

Raised face according to ASME B16.5: Ra 3.2 to 6.3 µm

Flange connection dimensions according to ASME B16.5: Class 600, Schedule 80

Triple-certified material, 1.4404/F316/F316L

Order code for "Process connection", option ACS

DN [mm]	A [mm]	B [mm]	C [mm]	D [mm]	E [mm]	L [mm]
15	95	66.5	4 × Ø15.7	23	13.9	207
25	125	88.9	4 × Ø19.1	27	24.3	252
40	155	114.3	4 × Ø22.4	31	38.1	234
50	165	127.0	8 × Ø 19.1	33	49.2	258
80	210	168.1	8 × Ø 22.4	39	73.7	264
100	275	215.9	8 × Ø 25.4	49	97	330
150	355	292.1	12 × Ø28.4	64	146.3	374
200	420	349.2	12 × Ø31.8	193.7	193.7	405
250	510	431.8	12 × Ø35	242.8	242.8	462
300	560	489	16 × Ø35	288.9	288.9	514

Raised face according to ASME B16.5: Ra 3.2 to 6.3 µm

Flange connection dimensions according to DIN EN 1092-1: PN 10

Triple-certified material, 1.4404/F316/F316L

Order code for "Process connection", option DDS

DN [mm]	A [mm]	B [mm]	C [mm]	D [mm]	E [mm]	L ¹⁾ [mm]
200	340	295	8 × Ø 22	24	193.7	251
250	395	350	12 × Ø22	26	242.8	282
300	445	400	12 × Ø22	26	288.9	328

Raised face according to DIN EN 1092-1 Form B1: Ra 3.2 to 12.5 µm

- 1) Version compliant with ISO 13359 available on request: for DN 200: 350 mm; for DN 250: 450 mm; for DN 300: 500 mm

Flange connection dimensions according to DIN EN 1092-1: PN 25						
<ul style="list-style-type: none"> ▪ Triple-certified material, 1.4404/F316/F316L ▪ Alloy C22/2.4602 (DN 15 to 150) 						
Order code for "Process connection", option DES						
DN [mm]	A [mm]	B [mm]	C [mm]	D [mm]	E [mm]	L ¹⁾ [mm]
200	360	310	12 × Ø26	30	193.7	287
250	425	370	12 × Ø30	32	242.8	322
300	485	430	16 × Ø30	34	288.9	376
Raised face according to DIN EN 1092-1 Form B1: Ra 3.2 to 12.5 µm						

- 1) Version compliant with ISO 13359 available on request: for DN 200: 350 mm; for DN 250: 450 mm; for DN 300: 500 mm

Flange connection dimensions according to DIN EN 1092-1: PN 16						
<ul style="list-style-type: none"> ▪ Triple-certified material, 1.4404/F316/F316L ▪ Alloy C22/2.4602 (DN 15 to 150) 						
Order code for "Process connection", option D1S						
DN [mm]	A [mm]	B [mm]	C [mm]	D [mm]	E [mm]	L ^{1) 2)} [mm]
100	220	180	8 × Ø 18	20	97.0	250
150	285	240	8 × Ø 22	22	146.3	300
200	340	295	12 × Ø22	24	193.7	251
250	405	355	12 × Ø26	26	242.8	286
300	460	410	12 × Ø26	28	288.9	348
Raised face according to DIN EN 1092-1 Form B1: Ra 3.2 to 12.5 µm						

- 1) Compliant with ISO 13359 for DN 100 to 150
 2) Version compliant with ISO 13359 available on request: for DN 200: 350 mm; for DN 250: 450 mm; for DN 300: 500 mm

Flange connection dimensions according to DIN EN 1092-1: PN 40						
<ul style="list-style-type: none"> ▪ Triple-certified material, 1.4404/F316/F316L ▪ Alloy C22/2.4602 (DN 15 to 150) 						
Order code for "Process connection", option D2S						
DN [mm]	A [mm]	B [mm]	C [mm]	D [mm]	E [mm]	L ^{1) 2)} [mm]
15	95	65	4 × Ø14	16	13.9	200
25	115	85	4 × Ø14	18	24.3	200
40	150	110	4 × Ø18	18	38.1	200
50	165	125	4 × Ø18	20	49.2	200
80	200	160	8 × Ø 18	24	73.7	200
100	235	190	8 × Ø 22	24	97	250
150	300	250	8 × Ø 26	28	146.3	300
200	375	320	12 × Ø30	34	193.7	303
250	450	385	12 × Ø33	38	242.8	356

Flange connection dimensions according to DIN EN 1092-1: PN 40						
<ul style="list-style-type: none"> ▪ Triple-certified material, 1.4404/F316/F316L ▪ Alloy C22/2.4602 (DN 15 to 150) 						
Order code for "Process connection", option D2S						
DN [mm]	A [mm]	B [mm]	C [mm]	D [mm]	E [mm]	L ^{1) 2)} [mm]
300	515	450	16 × Ø33	42	288.9	422
Raised face according to DIN EN 1092-1 Form B1: Ra 3.2 to 12.5 µm						

- 1) Compliant with ISO 13359 for DN 15 to 150
- 2) Version compliant with ISO 13359 available on request: for DN 200: 350 mm; for DN 250: 450 mm; for DN 300: 500 mm

Flange connection dimensions according to DIN EN 1092-1: PN 63						
Triple-certified material, 1.4404/F316/F316L						
Order code for "Process connection", option D3W						
DN [mm]	A [mm]	B [mm]	C [mm]	D [mm]	E [mm]	L [mm]
50	180	135	4 × Ø22	26	49.2	222
80	215	170	8 × Ø 22	28	73.7	228
100	250	200	8 × Ø 26	30	97	268
150	345	280	8 × Ø 33	36	146.3	316
200	415	345	12 × Ø36	42	193.7	347
250	470	400	12 × Ø36	46	242.8	396
300	530	460	16 × Ø36	52	288.9	472
Raised face according to DIN EN 1092-1 Form B1: Ra 3.2 to 12.5 µm						

Flange connection dimensions according to DIN EN 1092-1: PN 100						
Triple-certified material, 1.4404/F316/F316L						
Order code for "Process connection", option D4W						
DN [mm]	A [mm]	B [mm]	C [mm]	D [mm]	E [mm]	L [mm]
25	140	100	4 × Ø18	24	24.3	230
40	170	125	4 × Ø22	26	38.1	204
50	195	145	4 × Ø26	28	49.2	234
80	230	180	8 × Ø 26	32	73.7	240
100	265	210	8 × Ø 30	36	97	292
150	355	290	12 × Ø33	44	146.3	356
200	430	360	12 × Ø36	52	193.7	387
250	505	430	12 × Ø39	60	242.8	460
300	585	500	16 × Ø42	68	288.9	532
Raised face according to DIN EN 1092-1 Form B1: Ra 3.2 to 12.5 µm						

Flange connection dimensions according to DIN EN 1092-1: PN 16 with groove						
<ul style="list-style-type: none"> ▪ Triple-certified material, 1.4404/F316/F316L ▪ Alloy C22/2.4602 (DN 15 to 150) 						
Order code for "Process connection", option D5S						
DN [mm]	A [mm]	B [mm]	C [mm]	D [mm]	E [mm]	L ¹⁾ [mm]
100	220	180	8 × Ø 18	20	97	250
150	285	240	8 × Ø 22	22	146.3	300
Raised face according to DIN EN 1092-1 Form B1: Ra 3.2 to 12.5 µm						

- 1) Compliant with ISO 13359 for DN 100 to 150

Flange connection dimensions as per DIN EN 1092-1: PN 40 with groove						
<ul style="list-style-type: none"> ▪ Triple-certified material, 1.4404/F316/F316L ▪ Alloy C22/2.4602 (DN 15 to 150) 						
Order code for "Process connection", option D6S						
DN [mm]	A [mm]	B [mm]	C [mm]	D [mm]	E [mm]	L ^{1) 2)} [mm]
15	95	65	4 × Ø 14	16	13.9	200
25	115	85	4 × Ø 14	18	24.3	200
40	150	110	4 × Ø 18	18	38.1	200
50	165	125	4 × Ø 18	20	49.2	200
80	200	160	8 × Ø 18	24	73.7	200
100	235	190	8 × Ø 22	24	97	250
150	300	250	8 × Ø 26	28	146.3	300
Raised face according to DIN EN 1092-1 Form B1: Ra 3.2 to 12.5 µm						

- 1) Compliant with ISO 13359 for DN 15 to 150
 2) Version compliant with ISO 13359 available on request: for DN 200: 350 mm; for DN 250: 450 mm; for DN 300: 500 mm

Flange connection dimensions according to JIS B2220: 10K, Schedule 40/80						
Triple-certified material, 1.4404/F316/F316L						
Order code for "Process connection", option NDS/NFS						
DN [mm]	A [mm]	B [mm]	C [mm]	D [mm]	E [mm]	L [mm]
50	155	120	4 × Ø 19	16	49.2	200
80	185	150	8 × Ø 19	18	73.7	200
100	210	175	8 × Ø 19	18	97	250
150	280	240	8 × Ø 23	22	146.3	300
200	330	290	12 × Ø 23	22	193.7	247
250	400	355	12 × Ø 25	24	242.8	280
300	445	400	16 × Ø 25	24	288.9	334
Raised face according to JIS 2220: Ra 3.2 to 6.3 µm						

Flange connection dimensions according to JIS B2220: 20K, Schedule 40/80 Triple-certified material, 1.4404/F316/F316L Order code for "Process connection", option NES/NGS						
DN [mm]	A [mm]	B [mm]	C [mm]	D [mm]	E [mm]	L [mm]
15	95	70	4 × Ø15	14	13.9	200
25	125	90	4 × Ø19	16	24.3	200
40	140	105	4 × Ø19	18	38.1	200
50	155	120	8 × Ø 19	18	49.2	200
80	200	160	8 × Ø 23	22	73.7	200
100	225	185	8 × Ø 23	24	97	250
150	305	260	12 × Ø25	28	146.3	300
200	350	305	12 × Ø25	30	193.7	285
250	430	380	12 × Ø27	34	242.8	324
300	480	430	16 × Ø27	36	288.9	386

Raised face according to JIS 2220: Ra 3.2 to 6.3 µm

Accessories

Flow conditioner

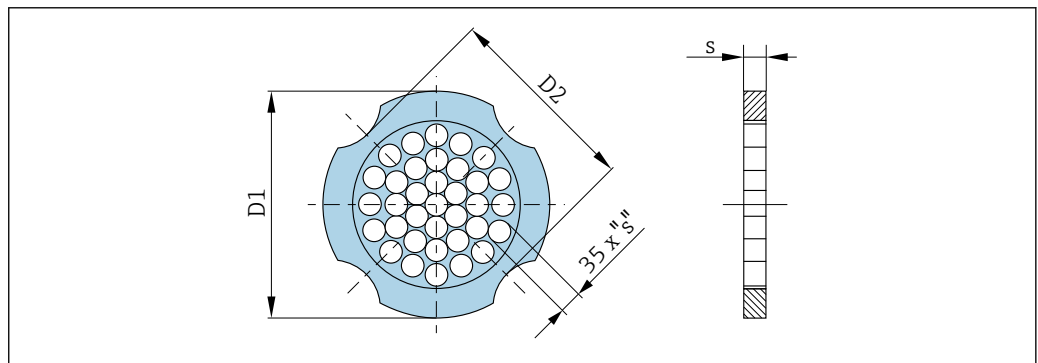

A0033504

Used in combination with flanges according to DIN EN 1092-1: PN 10 1.4404 (316, 316L) Order code for "Accessory enclosed", option PF			
DN [mm]	Centering diameter [mm]	D1 ¹⁾ / D2 ²⁾	s [mm]
15	54.3	D2	2.0
25	74.3	D1	3.5
40	95.3	D1	5.3
50	110.0	D2	6.8
80	145.3	D2	10.1
100	165.3	D2	13.3
150	221.0	D2	20.0
200	274.0	D1	26.3

Used in combination with flanges according to DIN EN 1092-1: PN 10 1.4404 (316, 316L) Order code for "Accessory enclosed", option PF			
DN [mm]	Centering diameter [mm]	D1 ¹⁾ / D2 ²⁾	s [mm]
250	330.0	D2	33.0
300	380.0	D2	39.6

- 1) The flow conditioner is fitted at the outer diameter between the bolts.
- 2) The flow conditioner is fitted at the indentations between the bolts.

Used in combination with flanges according to DIN EN 1092-1: PN 16 1.4404 (316, 316L) Order code for "Accessory enclosed", option PF			
DN [mm]	Centering diameter [mm]	D1 ¹⁾ / D2 ²⁾	s [mm]
15	54.3	D2	2.0
25	74.3	D1	3.5
40	95.3	D1	5.3
50	110.0	D2	6.8
80	145.3	D2	10.1
100	165.3	D2	13.3
150	221.0	D2	20.0
200	274.0	D2	26.3
250	330.0	D2	33.0
300	380.0	D2	39.6

- 1) The flow conditioner is fitted at the outer diameter between the bolts.
- 2) The flow conditioner is fitted at the indentations between the bolts.

Used in combination with flanges according to DIN EN 1092-1: PN 25 1.4404 (316, 316L) Order code for "Accessory enclosed", option PF			
DN [mm]	Centering diameter [mm]	D1 ¹⁾ / D2 ²⁾	s [mm]
15	54.3	D2	2.0
25	74.3	D1	3.5
40	95.3	D1	5.3
50	110.0	D2	6.8
80	145.3	D2	10.1
100	171.3	D1	13.3
150	227.0	D2	20.0
200	280.0	D1	26.3
250	340.0	D1	33.0
300	404.0	D1	39.6

- 1) The flow conditioner is fitted at the outer diameter between the bolts.
- 2) The flow conditioner is fitted at the indentations between the bolts.

Used in combination with flanges according to DIN EN 1092-1: PN 40 1.4404 (316, 316L) Order code for "Accessory enclosed", option PF			
DN [mm]	Centering diameter [mm]	D1 ¹⁾ / D2 ²⁾	s [mm]
15	54.3	D2	2.0
25	74.3	D1	3.5
40	95.3	D1	5.3
50	110.0	D2	6.8
80	145.3	D2	10.1
100	171.3	D1	13.3
150	227.0	D2	20.0
200	294.0	D2	26.3
250	355.0	D2	33.0
300	420.0	D1	39.6

- 1) The flow conditioner is fitted at the outer diameter between the bolts.
2) The flow conditioner is fitted at the indentations between the bolts.

Used in combination with flanges according to DIN EN 1092-1: PN 63 1.4404 (316, 316L) Order code for "Accessory enclosed", option PF			
DN [mm]	Centering diameter [mm]	D1 ¹⁾ / D2 ²⁾	s [mm]
15	64.3	D1	2.0
25	85.3	D1	3.5
40	106.3	D1	5.3
50	116.3	D1	6.8
80	151.3	D1	10.1
100	176.5	D2	13.3
150	252.0	D1	20.0

- 1) The flow conditioner is fitted at the outer diameter between the bolts.
2) The flow conditioner is fitted at the indentations between the bolts.

Used in combination with flanges according to ASME B16.5: Class 150 1.4404 (316, 316L) Order code for "Accessory enclosed", option PF			
DN [mm]	Centering diameter [mm]	D1 ¹⁾ / D2 ²⁾	s [mm]
15	50.1	D1	2.0
25	69.2	D2	3.5
40	88.2	D2	5.3
50	106.6	D2	6.8
80	138.4	D1	10.1
100	176.5	D2	13.3
150	223.5	D1	20.0
200	274.0	D2	26.3

Used in combination with flanges according to ASME B16.5: Class 150 1.4404 (316, 316L) Order code for "Accessory enclosed", option PF			
DN [mm]	Centering diameter [mm]	D1 ¹⁾ / D2 ²⁾	s [mm]
250	340.0	D1	33.0
300	404.0	D1	39.6

- 1) The flow conditioner is fitted at the outer diameter between the bolts.
- 2) The flow conditioner is fitted at the indentations between the bolts.

Used in combination with flanges according to ASME B16.5: Class 300 1.4404 (316, 316L) Order code for "Accessory enclosed", option PF			
DN [mm]	Centering diameter [mm]	D1 ¹⁾ / D2 ²⁾	s [mm]
15	56.5	D1	2.0
25	74.3	D1	3.5
40	97.7	D2	5.3
50	113.0	D1	6.8
80	151.3	D1	10.1
100	182.6	D1	13.3
150	252.0	D1	20.0
200	309.0	D1	26.3
250	363.0	D1	33.0
300	402.0	D1	39.6

- 1) The flow conditioner is fitted at the outer diameter between the bolts.
- 2) The flow conditioner is fitted at the indentations between the bolts.

Used in combination with flanges according to JIS B2220: 10K 1.4404 (316, 316L) Order code for "Accessory enclosed", option PF			
DN [mm]	Centering diameter [mm]	D1 ¹⁾ / D2 ²⁾	s [mm]
15	60.3	D2	2.0
25	76.3	D2	3.5
40	91.3	D2	5.3
50	106.6	D2	6.8
80	136.3	D2	10.1
100	161.3	D2	13.3
150	221.0	D2	20.0
200	271.0	D2	26.3
250	330.0	D2	33.0
300	380.0	D2	39.6

- 1) The flow conditioner is fitted at the outer diameter between the bolts.
- 2) The flow conditioner is fitted at the indentations between the bolts.

Used in combination with flanges according to JIS B2220: 20K
 1.4404 (316, 316L)
 Order code for "Accessory enclosed", option PF

DN [mm]	Centering diameter [mm]	D1 ¹⁾ / D2 ²⁾	s [mm]
15	60.3	D2	2.0
25	76.3	D2	3.5
40	91.3	D2	5.3
50	106.6	D2	6.8
80	142.3	D1	10.1
100	167.3	D1	13.3
150	240.0	D1	20.0
200	284.0	D1	26.3
250	355.0	D2	33.0
300	404.0	D1	39.6

- 1) The flow conditioner is fitted at the outer diameter between the bolts.
- 2) The flow conditioner is fitted at the indentations between the bolts.

Pressure measuring cell

 The "mass" sensor version (integrated pressure/temperature measurement) is available only for measuring devices in the HART communication mode.

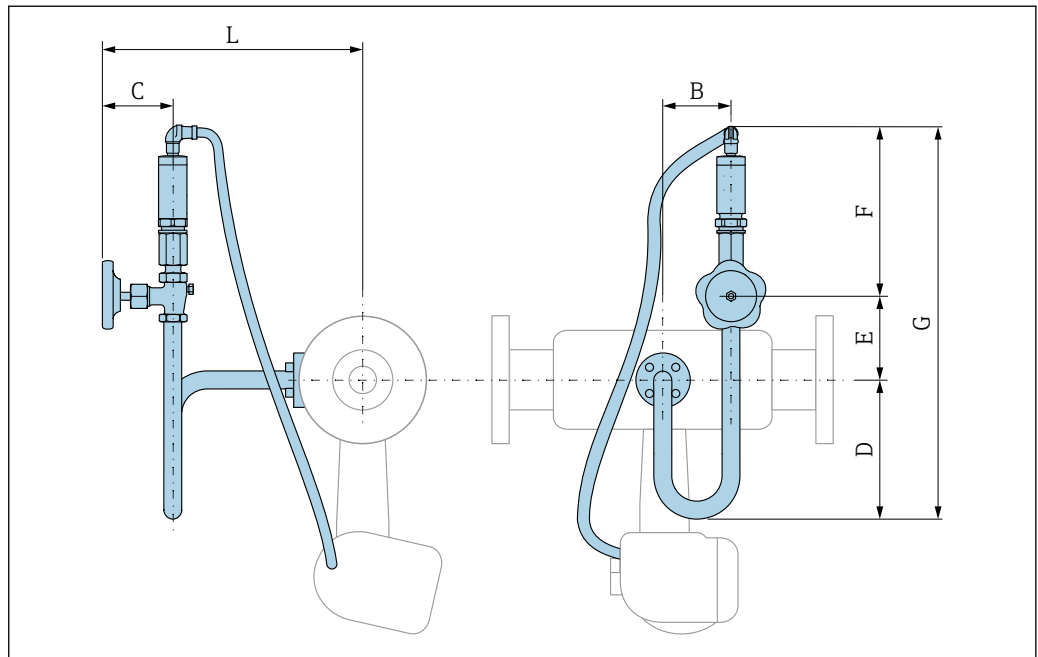

A0033851

Order code for "Sensor version; DSC sensor; measuring tube":
 Option DA "Mass steam; 316L; 316L (integrated pressure/temperature measurement)"

DN [mm]	B [mm]	C [mm]	D [mm]	E [mm]	F [mm]	G [mm]	L [mm]
25	76	78.8	155	60.8	190.5	407	307
40	76	78.8	155	60.8	190.5	407	314
50	76	78.8	155	60.8	190.5	407	320
80	76	78.8	155	60.8	190.5	407	331

Order code for "Sensor version; DSC sensor; measuring tube": Option DA "Mass steam; 316L; 316L (integrated pressure/temperature measurement)"							
DN [mm]	B [mm]	C [mm]	D [mm]	E [mm]	F [mm]	G [mm]	L [mm]
100	76	78.8	155	60.8	190.5	407	346
150	76	78.8	155	60.8	190.5	407	372
200	76	78.8	155	60.8	190.5	407	395
250	76	78.8	155	60.8	190.5	407	423
300	76	78.8	155	60.8	190.5	407	449

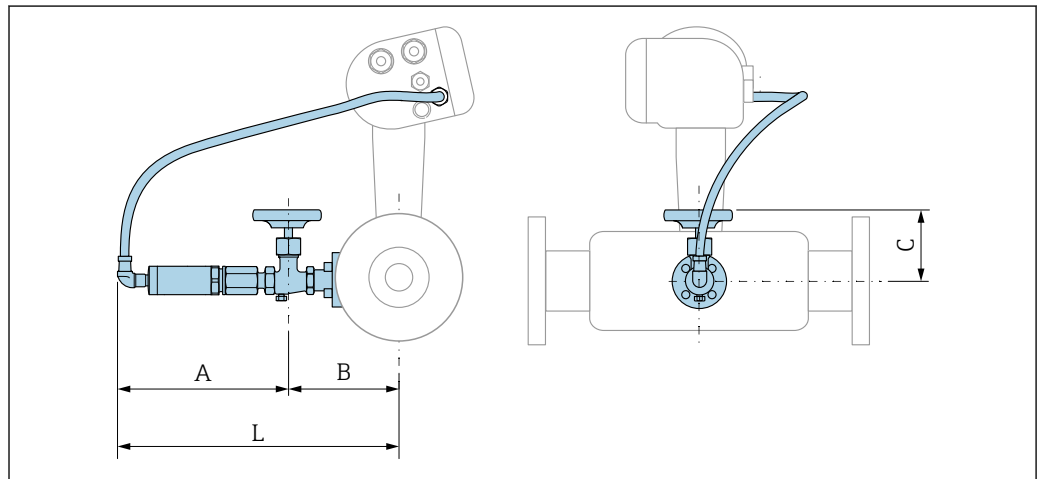

A0034024

Order code for "Sensor version; DSC sensor; measuring tube": Option DB "Mass gas/liquid; 316L; 316L (integrated pressure/temperature measurement)"				
DN [mm]	A [mm]	B [mm]	C [mm]	L [mm]
25	191	134	78.8	324
40	191	140	78.8	331
50	191	146	78.8	337
80	191	158	78.8	348
100	191	172	78.8	363
150	191	198	78.8	389
200	191	222	78.8	412
250	191	249	78.8	440
300	191	275	78.8	466

Dimensions in US units

Compact version

Order code for "Housing", option B "GT18, two-chamber, 316L, compact"; option C "GT20, two-chamber, aluminum, coated, compact"

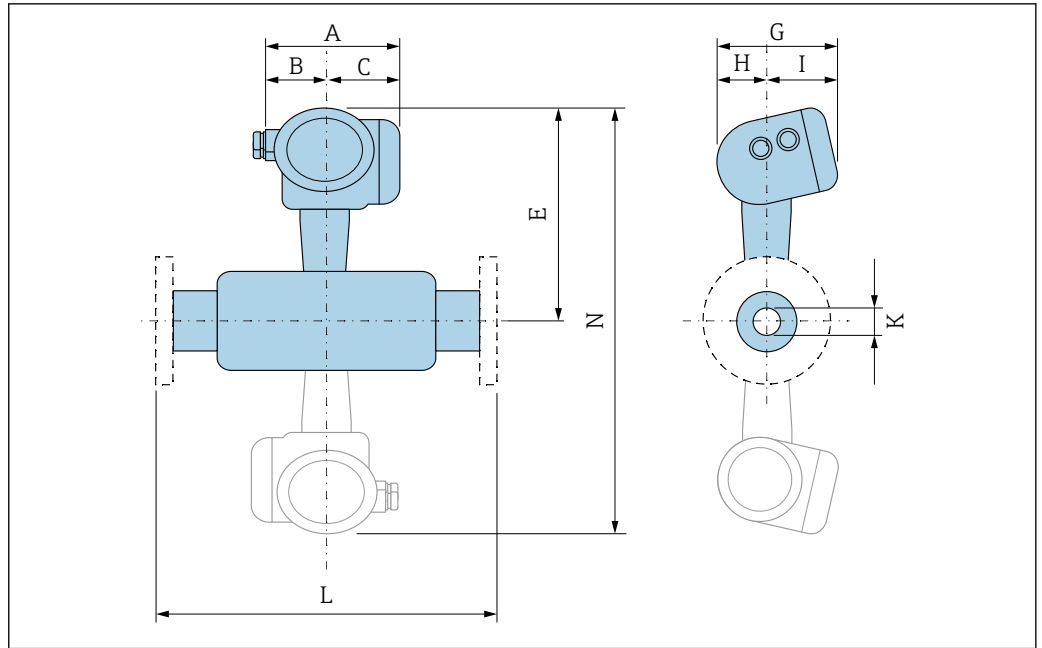

A0033794

27 Grayed out: Dualsens version

DN	A ¹⁾ 0.31 in	B	C ¹⁾	E ^{2) 3)}	G	H	I ⁴⁾	K (D ₁)	L	N ^{5) 6)}
[in]	[in]	[in]	[in]	[in]	[in]	[in]	[in]	[in]	[in]	[in]
½	5.52	2.04	3.48	9.92	6.3	2.29	4	0.55	7)	8)
1	5.52	2.04	3.48	10.2	6.3	2.29	4	0.96	7)	8)
1½	5.52	2.04	3.48	10.5	6.3	2.29	4	1.5	7)	20.9
2	5.52	2.04	3.48	10.7	6.3	2.29	4	1.94	7)	21.4
3	5.52	2.04	3.48	11.3	6.3	2.29	4	2.9	7)	22.5
4	5.52	2.04	3.48	11.8	6.3	2.29	4	3.82	7)	23.6
6	5.52	2.04	3.48	12.8	6.3	2.29	4	5.76	7)	25.6
8	5.52	2.04	3.48	13.7	6.3	2.29	4	7.63	7)	27.4
10	5.52	2.04	3.48	14.8	6.3	2.29	4	9.56	7)	29.5
12	5.52	2.04	3.48	15.6	6.3	2.29	4	11.4	7)	31.3

- 1) For version with overvoltage protection: values +
- 2) For version without local display: values - 0.39 in
- 3) For high-temperature/low-temperature version: values + 1.14 in
- 4) For version without local display: values - 0.28 in
- 5) For version without local display: values - 0.78 in
- 6) For high-temperature/low-temperature version: values + 2.28 in
- 7) Dependent on respective flange connection
- 8) Not available as a Dualsens version

Transmitter remote version

Order code for "Housing", option J "GT20 two-chamber, aluminum, coated, remote"; option K "GT18 two-chamber, 316L, remote"

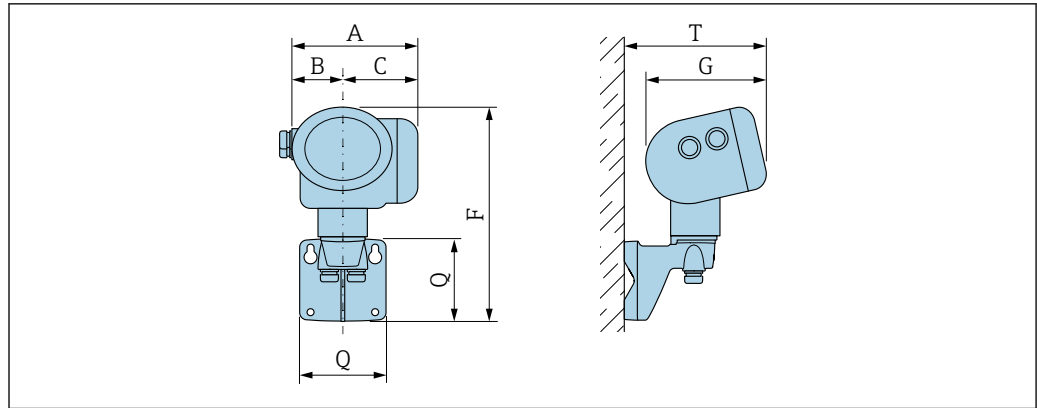

A0033796

A ¹⁾ [in]	B [in]	C ¹⁾ [in]	F ²⁾ [in]	G ³⁾ [in]	Q [in]	T ³⁾ [in]
5.52	2.04	3.48	10	6.3	4.21	7.52

- 1) For version with overvoltage protection: value + 0.31 in
- 2) For version without local display: value - 0.39 in
- 3) For version without local display: value - 0.28 in

Sensor remote version

Order code for "Housing", option J "GT20 two-chamber, aluminum, coated, remote"; option K "GT18 two-chamber, 316L, remote"

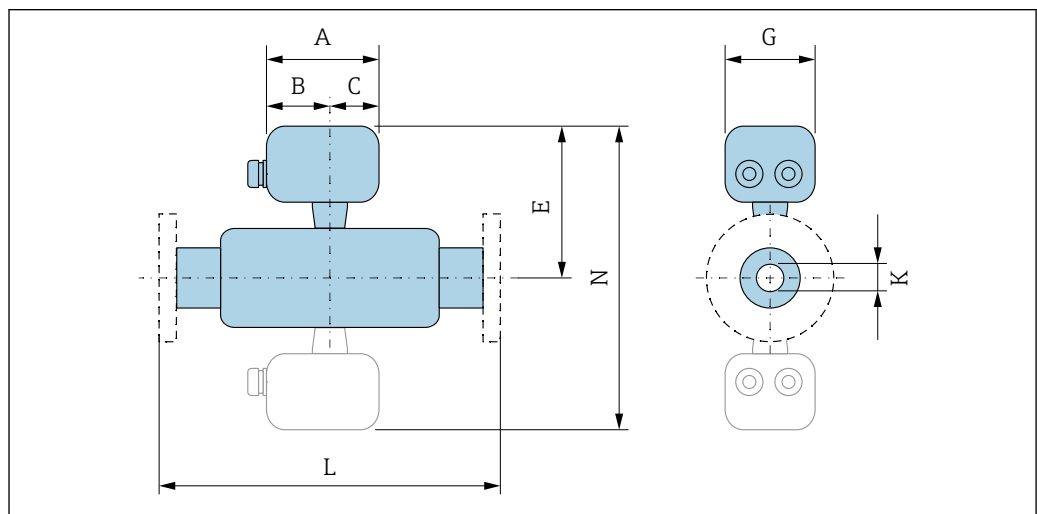

A0033797

28 *Grayed out: Dualsens version*

DN [in]	A [in]	B [in]	C [in]	E ¹⁾ [in]	G [in]	K (D _i) [in]	L [in]	N ²⁾ [in]
½	4.22	2.36	1.86	8.86	3.72	0.55	³⁾	⁴⁾
1	4.22	2.36	1.86	9.09	3.72	0.96	³⁾	⁴⁾
1½	4.22	2.36	1.86	9.41	3.72	1.5	³⁾	18.8
2	4.22	2.36	1.86	9.65	3.72	1.94	³⁾	19.3
3	4.22	2.36	1.86	10.2	3.72	2.9	³⁾	20.4
4	4.22	2.36	1.86	10.7	3.72	3.82	³⁾	21.5
6	4.22	2.36	1.86	11.7	3.72	5.76	³⁾	23.5

DN [in]	A [in]	B [in]	C [in]	E ¹⁾ [in]	G [in]	K (D _i) [in]	L [in]	N ²⁾ [in]
8	4.22	2.36	1.86	12.6	3.72	7.63	³⁾	25.2
10	4.22	2.36	1.86	13.7	3.72	9.56	³⁾	27.4
12	4.22	2.36	1.86	14.6	3.72	11.4	³⁾	29.2

- 1) For high-temperature/low-temperature version: values +1.14 in
- 2) For high-temperature/low-temperature version: values +2.28 in
- 3) Dependent on respective flange connection
- 4) Not available as a Dualsens version

Flange connections

Flange

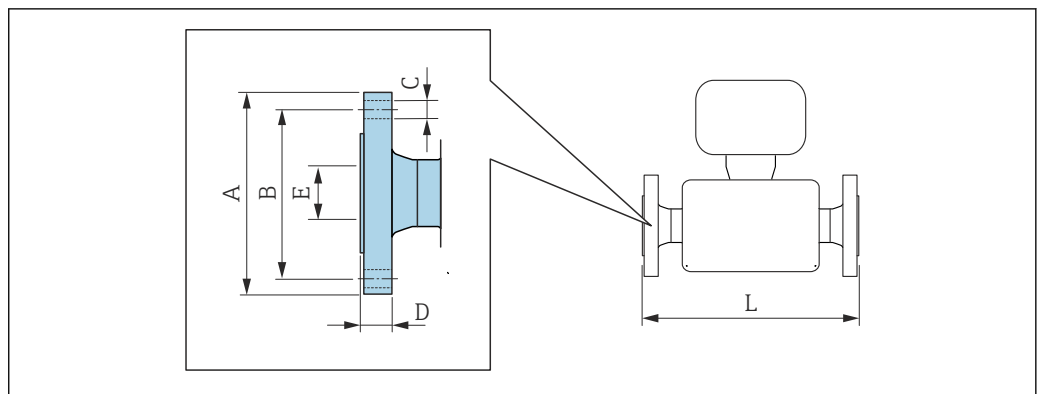

A0015621

- i** Length tolerance for dimension L in inch:
 DN ≤ 4": +0.06 to -0.08 in
 DN ≥ 6": ±0.14 in

Flange connection dimensions according to ASME B16.5: Class 150, Schedule 40/80						
<ul style="list-style-type: none"> ▪ Triple-certified material, 1.4404/F316/F316L ▪ Alloy C22/2.4602 (DN ½ to 6") 						
Order code for "Process connection", option AAS/AFS						
DN [in]	A [in]	B [in]	C [in]	D [in]	E [in]	L [in]
½	3.5	2.38	4 × Ø0.62	0.44	0.55	7.87
1	4.25	3.12	4 × Ø0.62	0.62	0.96	7.87
1½	5	3.88	4 × Ø0.62	0.69	1.5	7.87
2	6	4.75	4 × Ø0.75	0.75	1.94	7.87
3	7.5	6	4 × Ø0.75	0.94	2.9	7.87
4	9	7.5	8 × Ø0.75	0.96	3.82	9.84
6	11	9.5	8 × Ø0.88	1	5.76	11.81
8	13.6	11.8	8 × Ø0.88	1.14	7.63	12.95
10	15.9	14.3	12 × Ø1	1.2	9.56	13.7
12	19.1	17	12 × Ø1	1.27	11.4	16.46
Raised face according to ASME B16.5: Ra 125 to 250µin						

Flange connection dimensions according to ASME B16.5: Class 300, Schedule 40/80						
<ul style="list-style-type: none"> ▪ Triple-certified material, 1.4404/F316/F316L ▪ Alloy C22/2.4602 (DN ½ to 6") 						
Order code for "Process connection", option ABS/AGS						
DN [in]	A [in]	B [in]	C [in]	D [in]	E [in]	L [in]
½	3.74	2.62	4 × Ø0.62	0.56	0.55	7.87
1	4.87	3.5	4 × Ø0.75	0.75	0.96	7.87
1½	6.13	4.5	4 × Ø0.88	0.81	1.5	7.87
2	6.5	5	8 × Ø 0.75	0.88	1.94	7.87
3	8.27	6.62	8 × Ø 0.88	1.12	2.9	7.87
4	10	7.88	8 × Ø 0.88	1.25	3.82	9.84
6	12.5	10.6	12 × Ø0.88	1.44	5.76	11.81
8	15	13	12 × Ø1	1.64	7.63	13.78
10	17.5	15.3	16 × Ø1.13	1.89	9.56	14.96
12	20.5	17.7	16 × Ø1.25	2.02	11.4	17.72
Raised face according to ASME B16.5: Ra 125 to 250µin						

Flange connection dimensions according to ASME B16.5: Class 600, Schedule 80						
<ul style="list-style-type: none"> ▪ Triple-certified material, 1.4404/F316/F316L 						
Order code for "Process connection", option ACS						
DN [in]	A [in]	B [in]	C [in]	D [in]	E [in]	L [in]
½	3.74	2.62	4 × Ø0.62	0.91	0.55	8.15
1	4.92	3.5	4 × Ø0.75	1.06	0.96	9.92
1½	6.1	4.5	4 × Ø0.88	1.22	1.5	9.21
2	6.5	5	8 × Ø 0.75	1.3	1.94	10.16
3	8.27	6.62	8 × Ø 0.88	1.54	2.9	10.39
4	10.8	8.5	8 × Ø 1	1.93	3.82	12.99
6	14	11.5	12 × Ø1.12	2.52	5.76	14.72
8	16.5	13.7	12 × Ø1.25	7.63	7.63	15.94
10	20.1	17	12 × Ø1.38	9.56	9.56	18.19
12	22	19.3	16 × Ø1.38	11.4	11.4	20.24
Raised face according to ASME B16.5: Ra 125 to 250µin						

Accessories

Flow conditioner

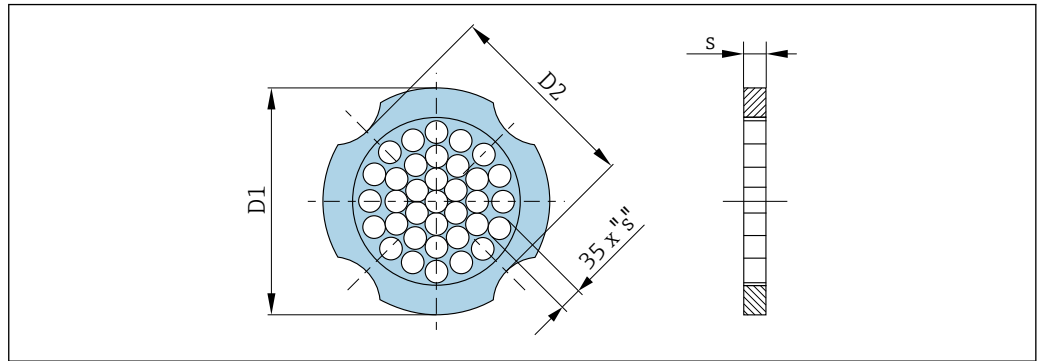

A0033504

**Used in combination with flanges according to ASME B16.5: Class 150
1.4404 (316, 316L)
Order code for "Accessory enclosed", option PF**

DN [in]	Centering diameter [in]	D1 ¹⁾ / D2 ²⁾	s [in]
½	1.97	D1	0.08
1	2.72	D2	0.14
1½	3.47	D2	0.21
2	4.09	D2	0.27
3	5.45	D1	0.40
4	6.95	D2	0.52
6	8.81	D1	0.79
8	10.80	D2	1.04
10	13.40	D1	1.30
12	15.90	D1	1.56

- 1) The flow conditioner is fitted at the outer diameter between the bolts.
- 2) The flow conditioner is fitted at the indentations between the bolts.

**Used in combination with flanges according to ASME B16.5: Class 300
1.4404 (316, 316L)
Order code for "Accessory enclosed", option PF**

DN [in]	Centering diameter [in]	D1 ¹⁾ / D2 ²⁾	s [in]
½	2.22	D1	0.08
1	2.93	D1	0.14
1½	3.85	D2	0.21
2	4.45	D1	0.27
3	5.96	D1	0.40
4	7.19	D1	0.52
6	9.92	D1	0.79
8	12.20	D1	1.04

Used in combination with flanges according to ASME B16.5: Class 300
1.4404 (316, 316L)
Order code for "Accessory enclosed", option PF

DN [in]	Centering diameter [in]	D1 ¹⁾ / D2 ²⁾	s [in]
10	14.30	D1	1.30
12	15.80	D1	1.56

- 1) The flow conditioner is fitted at the outer diameter between the bolts.
- 2) The flow conditioner is fitted at the indentations between the bolts.

Pressure measuring cell

i The "mass" sensor version (integrated pressure/temperature measurement) is available only for measuring devices in the HART communication mode.

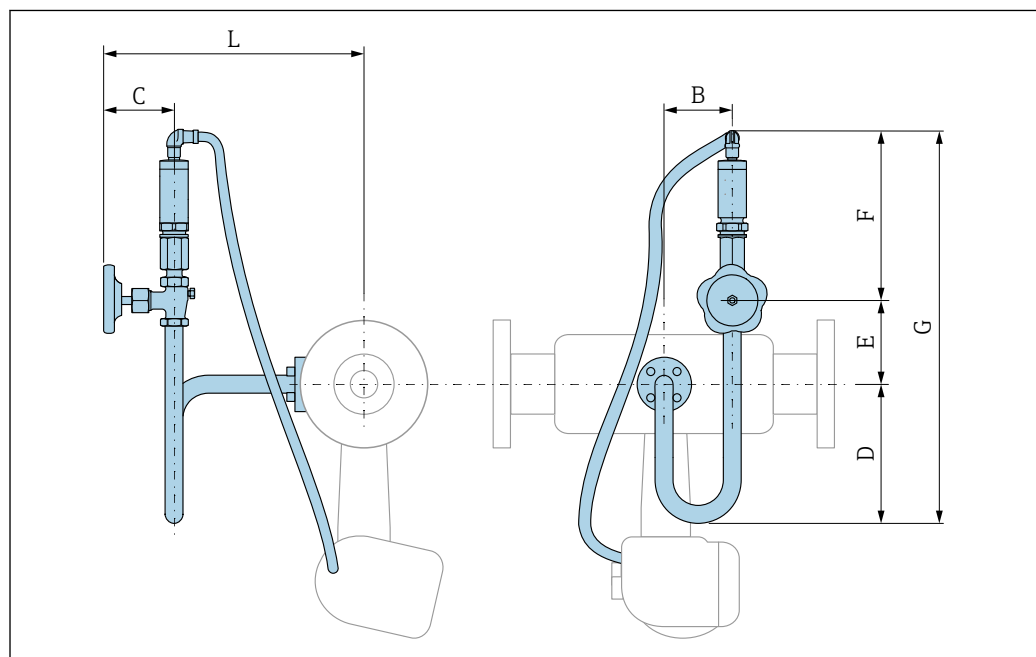

A0033851

Order code for "Sensor version; DSC sensor; measuring tube":
Option DA "Mass steam; 316L; 316L (integrated pressure/temperature measurement)"

DN [in]	B [in]	C [in]	D [in]	E [in]	F [in]	G [in]	L [in]
1	2.99	3.1	6.1	2.39	7.5	16.02	12.09
1½	2.99	3.1	6.1	2.39	7.5	16.02	12.36
2	2.99	3.1	6.1	2.39	7.5	16.02	12.6
3	2.99	3.1	6.1	2.39	7.5	16.02	13.03
4	2.99	3.1	6.1	2.39	7.5	16.02	13.62
6	2.99	3.1	6.1	2.39	7.5	16.02	14.65
8	2.99	3.1	6.1	2.39	7.5	16.02	15.55
10	2.99	3.1	6.1	2.39	7.5	16.02	16.65
12	2.99	3.1	6.1	2.39	7.5	16.02	17.68

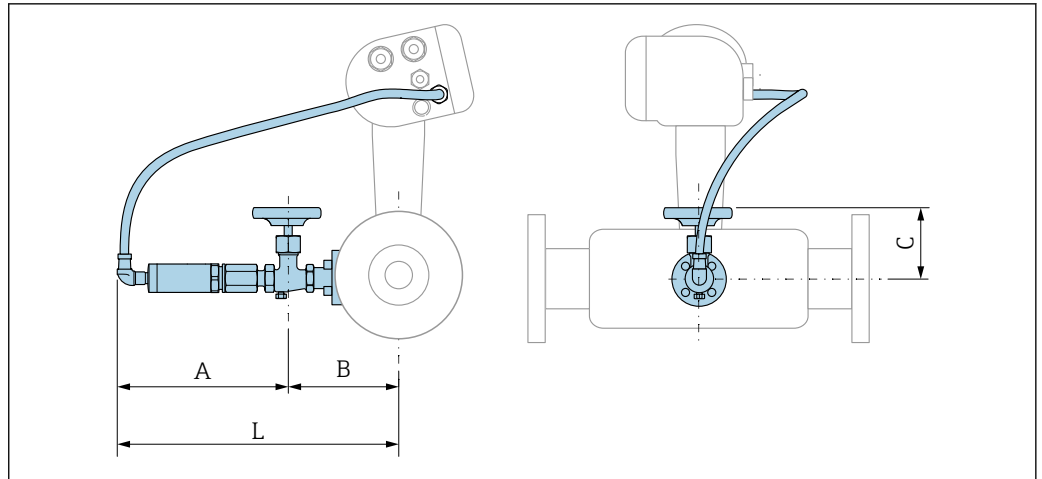

A0034024

Order code for "Sensor version; DSC sensor; measuring tube": Option DB "Mass gas/liquid; 316L; 316L (integrated pressure/temperature measurement)"				
DN [in]	A [in]	B [in]	C [in]	L [in]
1	7.52	5.28	3.1	12.76
1½	7.52	5.51	3.1	13.03
2	7.52	5.75	3.1	13.27
3	7.52	6.22	3.1	13.7
4	7.52	6.77	3.1	14.29
6	7.52	7.8	3.1	15.31
8	7.52	8.74	3.1	16.22
10	7.52	9.8	3.1	17.32
12	7.52	10.83	3.1	18.35

Weight

Compact version

Weight data:

- Including the transmitter:
 - Order code for "Housing", option C "GT20, two-chamber, aluminum, coated, compact"
1.8 kg (4.0 lb):
 - Order code for "Housing", option B "GT18 two-chamber, 316L, compact" 4.5 kg (9.9 lb):
- Excluding packaging material

Weight in SI units

All values (weight) refer to devices with EN (DIN), PN 40 flanges. Weight information in [kg].

DN [mm]	Weight [kg]	
	Order code for "Housing", option C "GT20 two-chamber, aluminum, coated, compact" ¹⁾	Order code for "Housing", option B "GT18 two-chamber, 316L, compact" ¹⁾
15	5.1	7.8
25	7.1	9.8
40	9.1	11.8
50	11.1	13.8
80	16.1	18.8
100	21.1	23.8
150	37.1	39.8

DN [mm]	Weight [kg]	
	Order code for "Housing", option C "GT20 two-chamber, aluminum, coated, compact" ¹⁾	Order code for "Housing", option B "GT18 two-chamber, 316L, compact" ¹⁾
200	72.1	74.8
250	111.1	113.8
300	158.1	160.8

1) For high-temperature/low-temperature version: values + 0.2 kg

Weight in US units

All values (weight) refer to devices with ASME B16.5, Class 300/Sch. 40 flanges. Weight information in [lbs].

DN [in]	Weight [lbs]	
	Order code for "Housing", option C "GT20 two-chamber, aluminum, coated, compact" ¹⁾	Order code for "Housing", option B "GT18 two-chamber, 316L, compact" ¹⁾
½	11.3	17.3
1	15.7	21.7
1½	22.4	28.3
2	26.8	32.7
3	42.2	48.1
4	66.5	72.4
6	110.5	116.5
8	167.9	173.8
10	240.6	246.6
12	357.5	363.4

1) For high-temperature/low-temperature version: values + 0.4 lbs

Transmitter remote version

Wall-mount housing

Dependent on the material of wall-mount housing:

- Order code for "Housing" option J "GT20 two-chamber, aluminum, coated, remote" 2.4 kg (5.2 lb):
- Order code for "Housing", option K "GT18 two-chamber, 316L, remote" 6.0 kg (13.2 lb):

Sensor remote version

Weight data:

- Including sensor connection housing:
 - Order code for "Housing" option J "GT20 two-chamber, aluminum, coated, remote" 0.8 kg (1.8 lb):
 - Order code for "Housing", option K "GT18 two-chamber, 316L, remote" 2.0 kg (4.4 lb):
- Excluding the connecting cable
- Excluding packaging material

Weight in SI units

All values (weight) refer to devices with EN (DIN), PN 40 flanges. Weight information in [kg].

DN [mm]	Weight [kg]	
	sensor connection housing Order code for "Housing", option J "GT20 two-chamber, aluminum, coated, remote" ¹⁾	sensor connection housing Order code for "Housing", option K "GT18 two-chamber, 316L, remote" ¹⁾
15	4.1	5.3
25	6.1	7.3
40	8.1	9.3
50	10.1	11.3
80	15.1	16.3
100	20.1	21.3
150	36.1	37.3
200	71.1	72.3
250	110.1	111.3
300	157.1	158.3

1) For high-temperature/low-temperature version: values + 0.2 kg

Weight in US units

All values (weight) refer to devices with ASME B16.5, Class 300/Sch. 40 flanges. Weight information in [lbs].

DN [in]	Weight [lbs]	
	sensor connection housing Order code for "Housing", option J "GT20 two-chamber, aluminum, coated, remote" ¹⁾	sensor connection housing Order code for "Housing", option K "GT18 two-chamber, 316L, remote" ¹⁾
½	8.9	11.7
1	13.4	16.1
1½	20.0	22.7
2	24.4	27.2
3	39.8	42.6
4	64.1	66.8
6	108.2	110.9
8	165.5	168.3
10	238.2	241.0
12	355.1	357.8

1) For high-temperature/low-temperature version: values + 0.4 lbs

Accessories

Flow conditioner

Weight in SI units

DN ¹⁾ [mm]	Pressure rating	Weight [kg]
15	PN 10 to 40	0.04
25	PN 10 to 40	0.1
40	PN 10 to 40	0.3
50	PN 10 to 40	0.5

DN ¹⁾ [mm]	Pressure rating	Weight [kg]
80	PN 10 to 40	1.4
100	PN10 to 40	2.4
150	PN 10/16 PN 25/40	6.3 7.8
200	PN 10 PN 16/25 PN 40	11.5 12.3 15.9
250	PN 10 to 25 PN 40	25.7 27.5
300	PN10 to 25 PN 40	36.4 44.7

1) EN (DIN)

DN ¹⁾ [mm]	Pressure rating	Weight [kg]
15	Class 150 Class 300	0.03 0.04
25	Class 150 Class 300	0.1
40	Class 150 Class 300	0.3
50	Class 150 Class 300	0.5
80	Class 150 Class 300	1.2 1.4
100	Class 150 Class 300	2.7
150	Class 150 Class 300	6.3 7.8
200	Class 150 Class 300	12.3 15.8
250	Class 150 Class 300	25.7 27.5
300	Class 150 Class 300	36.4 44.6

1) ASME

DN ¹⁾ [mm]	Pressure rating	Weight [kg]
15	20K	0.06
25	20K	0.1
40	20K	0.3
50	10K 20K	0.5
80	10K 20K	1.1
100	10K 20K	1.80

DN ¹⁾ [mm]	Pressure rating	Weight [kg]
150	10K	4.5
	20K	5.5
200	10K	9.2
	20K	
250	10K	15.8
	20K	19.1
300	10K	26.5
	20K	

1) JIS

Weight in US units

DN ¹⁾ [in]	Pressure rating	Weight [lbs]
½	Class 150	0.07
	Class 300	0.09
1	Class 150	0.3
	Class 300	
1½	Class 150	0.7
	Class 300	
2	Class 150	1.1
	Class 300	
3	Class 150	2.6
	Class 300	3.1
4	Class 150	6.0
	Class 300	
6	Class 150	14.0
	Class 300	16.0
8	Class 150	27.0
	Class 300	35.0
10	Class 150	57.0
	Class 300	61.0
12	Class 150	80.0
	Class 300	98.0

1) ASME

Materials

Transmitter housing

Compact version

- Order code for "Housing", option B "GT18 two-chamber, 316L, compact":
Stainless steel, CF3M
- Order code for "Housing", option C "GT20, two-chamber, aluminum, coated, compact":
Aluminum, AlSi10Mg, coated
- Window material: glass

Remote version

- Order code for "Housing" option J "GT20 two-chamber, aluminum, coated, remote":
Aluminum, AlSi10Mg, coated
- Order code for "Housing", option K "GT18 two-chamber, 316L, remote":
For maximum corrosion resistance: Stainless steel, CF3M
- Window material: glass

Cable entries/cable glands

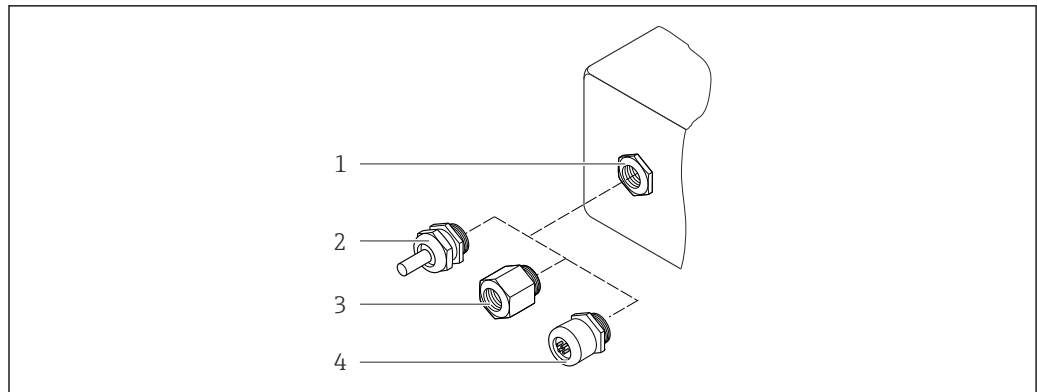

A0028352

29 Possible cable entries/cable glands

- 1 Female thread M20 × 1.5
- 2 Cable gland M20 × 1.5
- 3 Adapter for cable entry with internal thread G ½" or NPT ½"
- 4 Device plug connectors

Order code for "Housing", option B "GT18 two-chamber, 316L, compact" option K "GT18 two-chamber, 316L, remote"

Cable entry/cable gland	Type of protection	Material
Cable gland M20 × 1.5	<ul style="list-style-type: none"> ■ Non-hazardous area ■ Ex ia ■ Ex ic ■ Ex nA, Ex ec ■ Ex tb 	Stainless steel ,1.4404
Adapter for cable entry with internal thread G ½"	Non-hazardous area and hazardous area (except for XP)	Stainless steel, 1.4404 (316L)
Adapter for cable entry with internal thread NPT ½"	Non-hazardous area and hazardous area	

Order code for "Housing": option C "GT20 two-chamber, aluminum, coated, compact", option J "GT20, two-chamber, aluminum, coated remote"

i Applies also to the following device versions in combination with HART communication mode: Order code for "Sensor version; DSC sensor; measuring tube", option DA "mass steam; 316L; 316L", option DB "mass gas/liquid; 316L; 316L"

Cable entry/cable gland	Type of protection	Material
Cable gland M20 × 1.5	<ul style="list-style-type: none"> ■ Non-hazardous area ■ Ex ia ■ Ex ic 	Plastic
	Adapter for cable entry with internal thread G ½"	Nickel-plated brass
Adapter for cable entry with internal thread NPT ½"	Non-hazardous area and hazardous area (except for XP)	Nickel-plated brass
Thread NPT ½" via adapter	Non-hazardous area and hazardous area	

Connecting cable for remote version

- Standard cable: PVC cable with copper shield
- Reinforced cable: PVC cable with copper shield and additional steel wire braided jacket

Connecting cable, pressure measuring cell

 The "mass" sensor version (integrated pressure/temperature measurement) is available only for measuring devices in the HART communication mode.

Standard cable: PVC cable with copper shield

Sensor connection housing

The material of the sensor connection housing is dependent on the material selected for the transmitter housing.

- Order code for "Housing" option J "GT20 two-chamber, aluminum, coated, remote":
Coated aluminum AlSi10Mg
- Order code for "Housing", option K "GT18 two-chamber, 316L, remote":
Stainless cast steel, 1.4408 (CF3M)
Compliant with:
 - NACE MR0175
 - NACE MR0103

Measuring tubes

DN 15 to 300 (½ to 12"), pressure ratings PN 10/16/25/40 /63/100, Class 150/300 /600 , as well as JIS 10K/20K:

Stainless cast steel, CF3M/1.4408

Compliant with:

- NACE MR0175
- NACE MR0103
- DN15 to 150 (½ to 6"): AD2000, permitted temperature range -10 to +400 °C (+14 to +752 °F) restricted)

DN 15 to 150 (½ to 6"), pressure ratings PN 10/16/25/40, Class 150/300:

CX2MW similar to Alloy C22/2.4602

Compliant with:

- NACE MR0175
- NACE MR0103

DSC sensor

Order code for "Sensor version; DSC sensor; measuring tube", option **AA, BA, CA, DA, DB**

Pressure ratings PN 10/16/25/40/63/100, Class 150/300/600, as well as JIS 10K/20K:

Parts in contact with medium (marked as "wet" on the DSC sensor flange):

- Stainless steel 1.4404 and 316 and 316L
- Compliant with:
 - NACE MR0175/ISO 15156-2015
 - NACE MR0103/ISO 17945-2015

Parts not in contact with medium:

Stainless steel 1.4301 (304)

Order code for "Sensor version; DSC sensor; measuring tube", option **AB, AC, BB, CB, CC**

Pressure ratings PN 10/16/25/40/63/100, Class 150/300/600, as well as JIS 10K/20K:

Parts in contact with medium (marked as "wet" on the DSC sensor flange):

- Alloy C22, UNS N06022 similar to Alloy C22/2.4602
- Compliant with:
 - NACE MR0175/ISO 15156-2015
 - NACE MR0103/ISO 17945-2015

Parts not in contact with medium:

Alloy C22, UNS N06022 similar to Alloy C22/2.4602

Pressure measuring cell

 The "mass" sensor version (integrated pressure/temperature measurement) is available only for measuring devices in the HART communication mode.

- Wetted parts:
 - Process connection
Stainless steel, 1.4404/316L
 - Membrane
Stainless steel, 1.4435/316L
- Non-wetted parts:
 - Housing
Stainless steel, 1.4404

Order code for "Sensor version; DSC sensor; measuring tube", option DA, DB

- Siphon ⁴⁾
 - Stainless steel, 1.4571
- Adjusting nut
 - Stainless steel, 1.4571
- Pressure gauge valve
 - Stainless steel, 1.4571
- Welded connection on meter body
 - Stainless steel, multiple certifications 1.4404/316/316L
- Seals
 - Copper

Process connections

DN 15 to 300 (½ to 12"), pressure ratings PN 10/16/25/40/63/100, Class 150/300/600, as well as JIS 10K/20K:

Welding neck flanges DN 15 to 300 (½ to 12")

Compliant with:

NACE MR0175-2003

NACE MR0103-2003

The following materials are available depending on the pressure rating:

- Stainless steel, multiple certifications, 1.4404/F316/F316L)
- Alloy C22/2.4602



Available process connections → 85

Seals

- Graphite (standard)
 - Sigraflex foil™ (BAM-tested for oxygen applications, "high-grade in the context of TA-Luft Clean Air Guidelines")
- FPM (Viton™)
- Kalrez 6375™
- Gylon 3504™ (BAM-tested for oxygen applications, "high-grade in the context of TA-Luft clean air guidelines")

Order code for "Sensor version; DSC sensor; measuring tube", option DA, DB

Copper

Housing support

Stainless steel, 1.4408 (CF3M)

Screws for DSC sensor

- Order code for "Sensor version", option AA, BA, CA, DA, DB
 - Stainless steel, A2-80 according to ISO 3506-1 (304)
- Order code for "Additional approval", option LL "AD 2000 (including option JA+JB+JK) > DN25 including option LK"
 - Stainless steel, A4-80 according to ISO 3506-1 (316)
- Order code for "Sensor version", option AB, AC, BB, CB, CC
 - Stainless steel, 1.4980 according to EN 10269 (Gr. 660 B)

4) Only with order code for "Sensor version; DSC sensor; measuring tube", option DA available.

Accessories

Protective cover

Stainless steel, 1.4404 (316L)

Flow conditioner

- Stainless steel, multiple certifications, 1.4404 (316, 316L)
- Compliant with:
 - NACE MRO175-2003
 - NACE MRO103-2003

Flange connections

Flange connection dimensions and raised face in accordance with:

- DIN EN 1092-1
- ASME B16.5
- JIS B2220



For information on the different materials used in the flange connections → 84

Operability

Operating concept

Operator-oriented menu structure for user-specific tasks

- Commissioning
- Operation
- Diagnostics
- Expert level

Quick and safe commissioning

- Guided menus ("Make-it-run" wizards) for applications
- Menu guidance with brief explanations of the individual parameter functions

Reliable operation

- Operation in the following languages:
 - Via local display:
English, German, French, Spanish, Italian, Dutch, Portuguese, Polish, Russian, Swedish, Turkish, Chinese, Japanese, Korean, Bahasa (Indonesian), Vietnamese, Czech
 - Via "FieldCare" operating tool:
English, German, French, Spanish, Italian, Chinese, Japanese
- Uniform operating philosophy applied to device and operating tools
- If replacing the electronic module, transfer the device configuration via the integrated memory (integrated HistoROM) which contains the process and measuring device data and the event logbook. No need to reconfigure.

Efficient diagnostics increase measurement availability

- Troubleshooting measures can be called up via the device and in the operating tools
- Diverse simulation options, logbook for events that occur and optional line recorder functions

Languages

Can be operated in the following languages:

- Via local display:
English, German, French, Spanish, Italian, Dutch, Portuguese, Polish, Russian, Swedish, Turkish, Chinese, Japanese, Korean, Bahasa (Indonesian), Vietnamese, Czech
- Via "FieldCare" operating tool:
English, German, French, Spanish, Italian, Chinese, Japanese

Local operation**Via display module**

Two display modules are available:

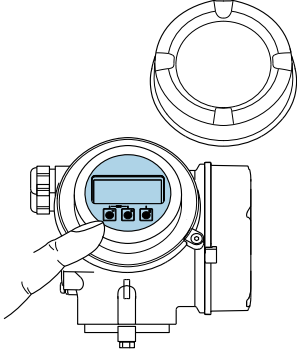
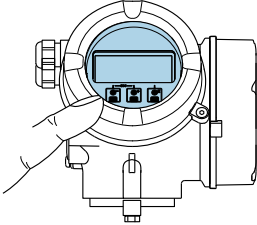
Order code for "Display; Operation", option C "SD02"	Order code for "Display; Operation", option E "SD03"
	
1 Operation with pushbuttons	1 Operation with touch control

Display elements

- 4-line, illuminated, graphic display
- White background lighting; switches to red in event of device errors
- Format for displaying measured variables and status variables can be individually configured
- Permitted ambient temperature for the display: -20 to $+60$ °C (-4 to $+140$ °F)
The readability of the display may be impaired at temperatures outside the temperature range.

Operating elements

- Operation with 3 push buttons with open housing: \oplus , \ominus , \boxplus
or
- External operation via touch control (3 optical keys) without opening the housing: \oplus , \ominus , \boxplus
- Operating elements also accessible in the various zones of the hazardous area

Additional functionality

- Data backup function
The device configuration can be saved in the display module.
- Data comparison function
The device configuration saved in the display module can be compared to the current device configuration.
- Data transfer function
The transmitter configuration can be transmitted to another device using the display module.

Via remote display FHX50

-  The remote display FHX50 can be ordered as an optional extra → 95.
- The remote display FHX50 cannot be combined with the order code for "Sensor version; DSC sensor; measuring tube", option DA "mass steam" or option DB "mass gas/liquid".

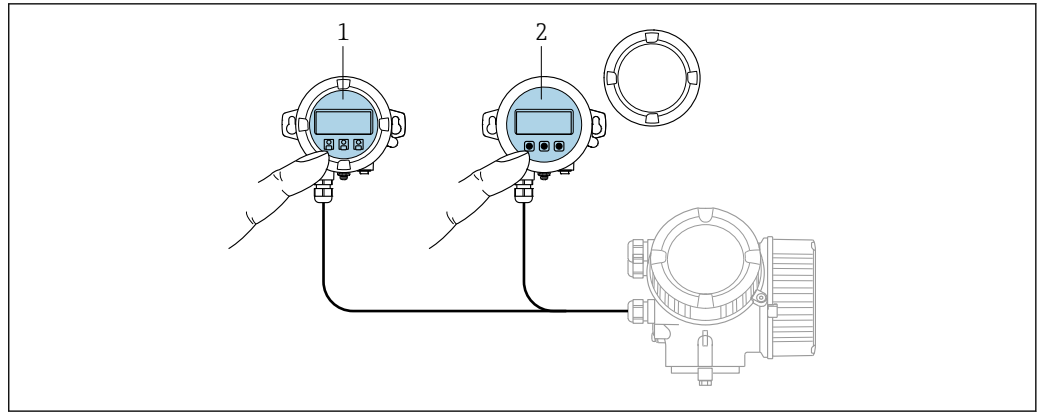

A0032215

30 FHX50 operating options

- 1 SD02 display and operating module, push buttons: cover must be opened for operation
- 2 SD03 display and operating module, optical buttons: operation possible through cover glass

Display and operating elements

The display and operating elements correspond to those of the display module .

Remote operation

Via HART protocol

This communication interface is available in device versions with a HART output.

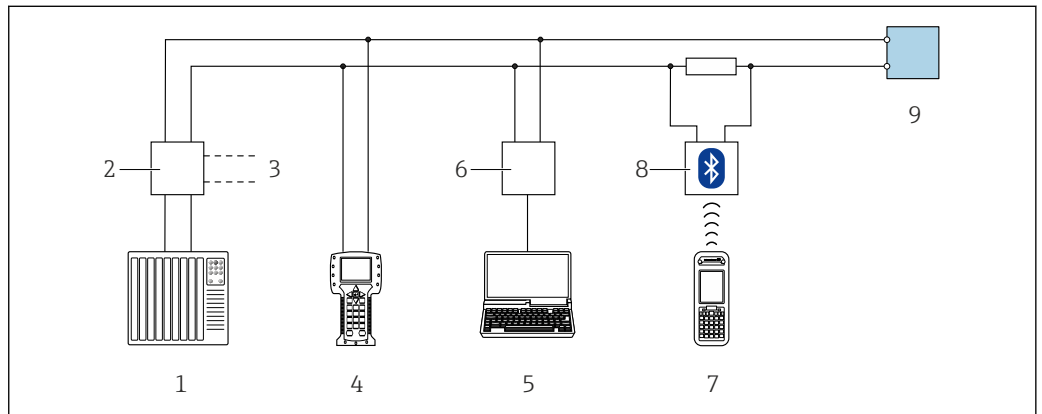

A0028746

31 Options for remote operation via HART protocol (passive)

- 1 Control system (e.g. PLC)
- 2 Transmitter power supply unit, e.g. RN221N (with communication resistor)
- 3 Connection for Commubox FXA195 and Field Communicator 475
- 4 Field Communicator 475
- 5 Computer with web browser (e.g. Internet Explorer) for accessing computers with operating tool (e.g. FieldCare, DeviceCare, AMS Device Manager, SIMATIC PDM) with COM DTM "CDI Communication TCP/IP"
- 6 Commubox FXA195 (USB)
- 7 Field Xpert SFX350 or SFX370
- 8 VIATOR Bluetooth modem with connecting cable
- 9 Transmitter

Via PROFIBUS PA network

This communication interface is available in device versions with PROFIBUS PA.

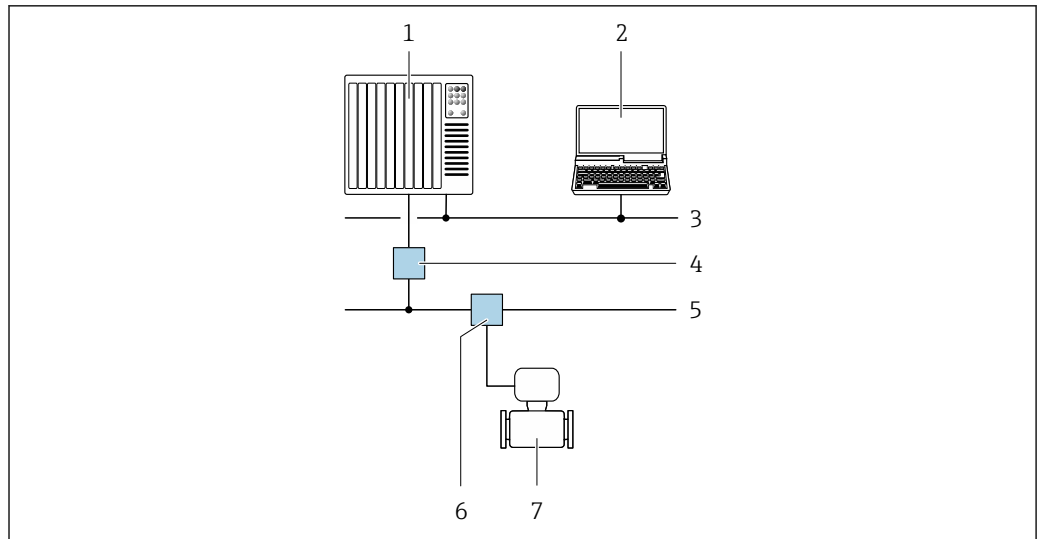

A0028838

32 Options for remote operation via PROFIBUS PA network

- 1 Automation system
- 2 Computer with PROFIBUS network card
- 3 PROFIBUS DP network
- 4 Segment coupler PROFIBUS DP/PA
- 5 PROFIBUS PA network
- 6 T-box
- 7 Measuring device

Via FOUNDATION Fieldbus network

This communication interface is available in device versions with FOUNDATION Fieldbus.

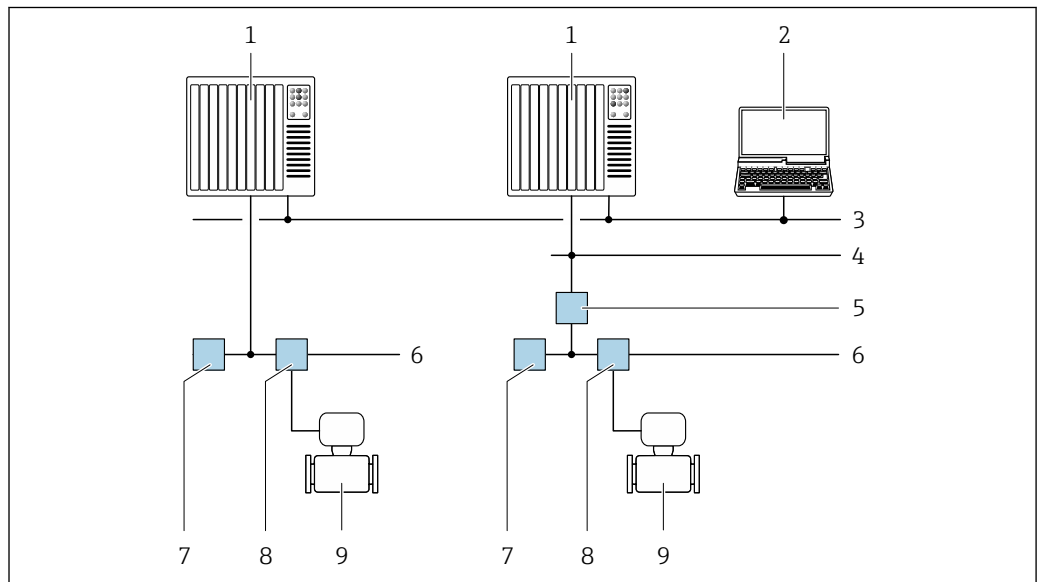

A0028837

33 Options for remote operation via FOUNDATION Fieldbus network

- 1 Automation system
- 2 Computer with FOUNDATION Fieldbus network card
- 3 Industry network
- 4 High Speed Ethernet FF-HSE network
- 5 Segment coupler FF-HSE/FF-H1
- 6 FOUNDATION Fieldbus FF-H1 network
- 7 Power supply FF-H1 network
- 8 T-box
- 9 Measuring device

Service interface

Via service interface (CDI)

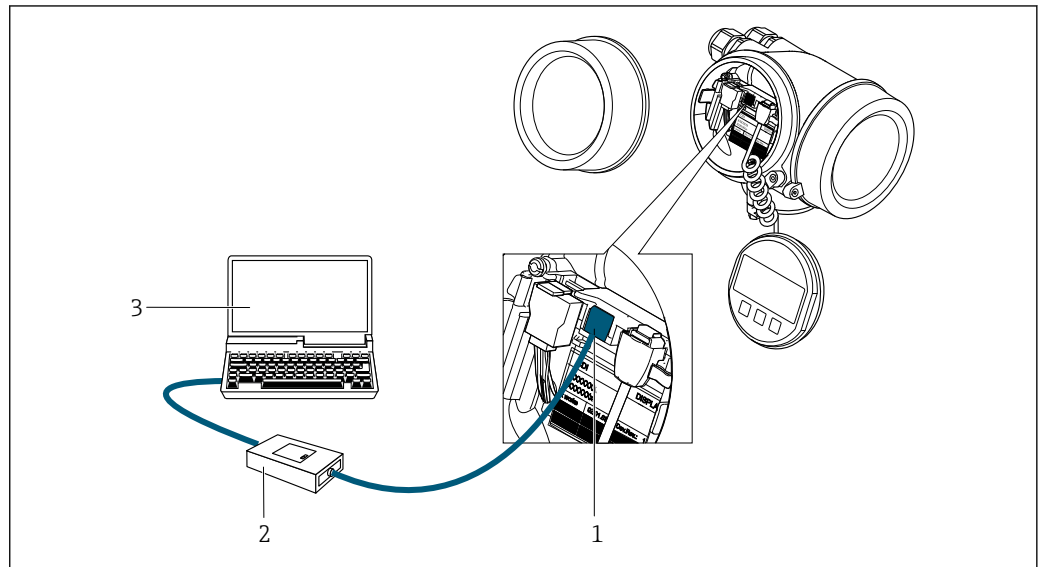

- 1 Service interface (CDI = Endress+Hauser Common Data Interface) of the measuring device
- 2 Commubox FXA291
- 3 Computer with FieldCare operating tool with COM DTM CDI Communication FXA291

A0034056

Certificates and approvals

CE mark

The measuring system is in conformity with the statutory requirements of the applicable EU Directives. These are listed in the corresponding EU Declaration of Conformity along with the standards applied.

Endress+Hauser confirms successful testing of the device by affixing to it the CE mark.

C-Tick symbol

The measuring system meets the EMC requirements of the "Australian Communications and Media Authority (ACMA)".

Ex approval

The measuring device is certified for use in hazardous areas and the relevant safety instructions are provided in the separate "Safety Instructions" (XA) document. Reference is made to this document on the nameplate.



The separate Ex documentation (XA) containing all the relevant explosion protection data is available from your Endress+Hauser sales center.

ATEX, IECEx

Currently, the following versions for use in hazardous areas are available:

Ex d

Category	Type of protection
II2G/Zone 1	Ex d[ia] IIC T6 ... T1
II1/2G/Zone 0/1	Ex d[ia] IIC T6 ... T1

Ex ia

Category	Type of protection
II2G/Zone 1	Ex ia IIC T6 ... T1
II1G/Zone 0	Ex ia IIC T6 ... T1
II1/2G/Zone 0/1	Ex ia IIC T6 ... T1

Ex ic

Category	Type of protection
II3G/Zone 2	Ex ic IIC T6 ... T1
II1/3G/Zone 0/2	Ex ic ia IIC T6 ... T1

Ex Ec

Category	Type of protection
II3G/Zone 2	Ex ec IIC T6 ... T1

Ex tb

Category	Type of protection
II2D/Zone 21	Ex tb IIIC Txxx

cCSAus

Currently, the following versions for use in hazardous areas are available:

XP

Category	Type of protection
Class I, II, III, Division 1 for Group A-G	XP (Ex d Flameproof version)

IS

Category	Type of protection
Class I, II, III, Division 1 for Group A-G	IS (Ex i Intrinsically safe version)

NI

Category	Type of protection
Class I, Division 2 for Group ABCD	NI (Non-incendive version), NIFW-Parameter*

*= Entity and NIFW parameters according to control drawings

NEPSI

Currently, the following versions for use in hazardous areas are available:

Ex d

Category	Type of protection
Zone 1	Ex d ia IIC T1 ~ T6 Ex d ia Ga IIC T1 ~ T6
Zone 0/1	Ex d ia IIC T1 ~ T6 DIP A21 Ex d ia Ga IIC T1 ~ T6 DIP A21

Ex ia

Category	Type of protection
Zone 1	Ex ia IIC T1 ~ T6
Zone 0/1	Ex ia IIC T1 ~ T6 DIP A2.1

Ex ic

Category	Type of protection
II3G/Zone 2	Ex ic IIC T1 ~ T6
II1/3G/Zone 0/2	Ex ic ia Ga IIC T1 ~ T6

Ex nA

Category	Type of protection
Zone 2	Ex nA IIC T1 ~ T6 Ex nA ia Ga IIC T1 ~ T6

INMETRO

Currently, the following versions for use in hazardous areas are available:

Ex d

Category	Type of protection
-	Ex d ia IIC T6 ... T1

Ex ia

Category	Type of protection
-	Ex ia IIC T6 ... T1

Ex nA

Category	Type of protection
II3G/Zone 2	Ex nA IIC T6 ... T1

EAC

Ex d

Category	Type of protection
Zone 1	1Ex d ia Ga IIC T6 ... T1 Gb
	Ga/Gb Ex d ia Ga IIC T6 ... T1

Ex nA

Category	Type of protection
Zone 2	2Ex nA ia Ga IIC T6 ... T1 Gc

Functional safety

The measuring device can be used for flow monitoring systems (min., max., range) up to SIL 2 (single-channel architecture; order code for "Additional approval", option LA) and SIL 3 (multichannel architecture with homogeneous redundancy) and is independently evaluated and certified by the TÜV in accordance with IEC 61508.

The following types of monitoring in safety equipment are possible:
Volume flow



Functional Safety Manual with information on the SIL device → 98

HART certification

HART interface

The measuring device is certified and registered by the FieldComm Group. The measuring system meets all the requirements of the following specifications:

- Certified according to HART
- The device can also be operated with certified devices of other manufacturers (interoperability)

FOUNDATION Fieldbus certification

FOUNDATION Fieldbus interface

The measuring device is certified and registered by the FieldComm Group. The measuring system meets all the requirements of the following specifications:

- Certified in accordance with FOUNDATION Fieldbus H1
- Interoperability Test Kit (ITK), revision version 6.2.0 (certificate available on request)
- Physical Layer Conformance Test
- The device can also be operated with certified devices of other manufacturers (interoperability)

Certification PROFIBUS

PROFIBUS interface

The measuring device is certified and registered by the PNO (PROFIBUS User Organization Organization). The measuring system meets all the requirements of the following specifications:

- Certified in accordance with PROFIBUS PA Profile 3.02
- The device can also be operated with certified devices of other manufacturers (interoperability)

Pressure Equipment Directive

The devices can be ordered with or without a PED approval. If a device with a PED approval is required, this must be explicitly stated in the order.

- With the identification PED/G1/x (x = category) on the sensor nameplate, Endress+Hauser confirms conformity with the "Essential Safety Requirements" specified in Appendix I of the Pressure Equipment Directive 2014/68/EC.
- Devices bearing this marking (PED) are suitable for the following types of medium:
Media in Group 1 and 2 with a vapor pressure greater than, or smaller and equal to 0.5 bar (7.3 psi)
- Devices not bearing this marking (PED) are designed and manufactured according to good engineering practice. They meet the requirements of Art. 4, Par. 3 of the Pressure Equipment Directive 2014/68/EU. The range of application is indicated in tables 6 to 9 in Annex II of the Pressure Equipment Directive 2014/68/EC.

Experience

The Prowirl 200 measuring system is the official successor to Prowirl 72 and Prowirl 73.

Other standards and guidelines

- EN 60529
Degrees of protection provided by enclosures (IP code)
- DIN ISO 13359
Measurement of conductive liquid flow in closed conduits - Flanged-type electromagnetic flowmeters - Overall length
- EN 61010-1
Safety requirements for electrical equipment for measurement, control and laboratory use - general requirements
- IEC/EN 61326
Emission in accordance with Class A requirements. Electromagnetic compatibility (EMC requirements).
- NAMUR NE 21
Electromagnetic compatibility (EMC) of industrial process and laboratory control equipment
- NAMUR NE 32
Data retention in the event of a power failure in field and control instruments with microprocessors
- NAMUR NE 43
Standardization of the signal level for the breakdown information of digital transmitters with analog output signal.
- NAMUR NE 53
Software of field devices and signal-processing devices with digital electronics

- NAMUR NE 105
Specifications for integrating fieldbus devices in engineering tools for field devices
- NAMUR NE 107
Self-monitoring and diagnosis of field devices
- NAMUR NE 131
Requirements for field devices for standard applications

Ordering information

Detailed ordering information is available as follows:

- In the Product Configurator on the Endress+Hauser website: www.endress.com -> Click "Corporate" -> Select your country -> Click "Products" -> Select the product using the filters and search field -> Open product page -> The "Configure" button to the right of the product image opens the Product Configurator.
- From your Endress+Hauser Sales Center: www.addresses.endress.com



Product Configurator - the tool for individual product configuration

- Up-to-the-minute configuration data
- Depending on the device: Direct input of measuring point-specific information such as measuring range or operating language
- Automatic verification of exclusion criteria
- Automatic creation of the order code and its breakdown in PDF or Excel output format
- Ability to order directly in the Endress+Hauser Online Shop

Product generation index

Release date	Product root	On change
01.09.2013	7F2B	TI01084D
01.11.2017	7F2C	TI01333D



More information is available from your Sales Center or at:

www.service.endress.com → Downloads

Application packages

Many different application packages are available to enhance the functionality of the device. Such packages might be needed to address safety aspects or specific application requirements.

The application packages can be ordered with the device or subsequently from Endress+Hauser. Detailed information on the order code in question is available from your local Endress+Hauser sales center or on the product page of the Endress+Hauser website: www.endress.com.



Detailed information on the application packages:
Special Documentation for the device

Diagnostics functions

Package	Description
Extended HistoROM	<p>Comprises extended functions concerning the event log and the activation of the measured value memory.</p> <p>Event log: Memory volume is extended from 20 message entries (standard version) to up to 100 entries.</p> <p>Data logging (line recorder):</p> <ul style="list-style-type: none"> ■ Memory capacity for up to 1000 measured values is activated. ■ 250 measured values can be output via each of the 4 memory channels. The recording interval can be defined and configured by the user. ■ Measured value logs can be accessed via the local display or operating tool e.g. FieldCare, DeviceCare or Web server.

Heartbeat Technology

Package	Description
Heartbeat Verification	<p>Heartbeat Verification</p> <p>Meets the requirement for traceable verification to DIN ISO 9001:2008 Chapter 7.6 a) "Control of monitoring and measuring equipment".</p> <ul style="list-style-type: none"> ■ Functional testing in the installed state without interrupting the process. ■ Traceable verification results on request, including a report. ■ Simple testing process via local operation or other operating interfaces. ■ Clear measuring point assessment (pass/fail) with high test coverage within the framework of manufacturer specifications. ■ Extension of calibration intervals according to operator's risk assessment.

Wet steam detection

Package	Description
Wet steam detection	<p>Wet steam detection provides a qualitative parameter for monitoring the steam application. It is an additional indicator for checking steam quality. A warning is displayed as soon as the steam quality drops below $x = 0.80$ (80%).</p> <ul style="list-style-type: none"> ■ Additional quality parameter for ensuring a safe and efficient steam process ■ Additional indicator to monitor the operation of steam traps

Wet steam measurement





Package	Description
Wet steam measurement	<p>Innovative measurement of the steam quality and degree of overheating. The wet steam detection application package extends wet steam measurement to include the continuous display of the steam quality. The steam quality is used to calculate the correct volume flow and mass flow and can be assigned to outputs. The condensate amount can be displayed. By evaluating the data, deviations in the process can be quickly detected.</p> <ul style="list-style-type: none"> ■ As the warning values can be freely defined, users have optimum control of the steam process. ■ Additional quality parameter for ensuring a safe and efficient steam process. ■ Additional indicator to monitor the operation of steam traps. ■ Combined with active pressure compensation, the device guarantees correct steam measurement. ■ Automatic calculation of the steam state and correct measurement of the steam amount. ■ Automatic navigation through the steam areas (wet steam, saturated steam and superheated steam).



Accessories

Various accessories, which can be ordered with the device or subsequently from Endress+Hauser, are available for the device. Detailed information on the order code in question is available from your local Endress+Hauser sales center or on the product page of the Endress+Hauser website:

www.endress.com.

Device-specific accessories For the transmitter









Accessories	Description
Prowirl 200 transmitter	<p>Transmitter for replacement or storage. Use the order code to define the following specifications:</p> <ul style="list-style-type: none"> ▪ Approvals ▪ Output, Input ▪ Display/operation ▪ Housing ▪ Software <p> Installation Instructions EA01056D</p> <p>(Order number: 7X2CXX)</p>
Remote display FHX50	<p>FHX50 housing for accommodating a display module .</p> <ul style="list-style-type: none"> ▪ FHX50 housing suitable for: <ul style="list-style-type: none"> - SD02 display module (push buttons) - SD03 display module (touch control) ▪ Length of connecting cable: up to max. 60 m (196 ft) (cable lengths available for order: 5 m (16 ft), 10 m (32 ft), 20 m (65 ft), 30 m (98 ft)) <p>The measuring device can be ordered with the FHX50 housing and a display module. The following options must be selected in the separate order codes:</p> <ul style="list-style-type: none"> ▪ Order code for measuring device, feature 030: Option L or M "Prepared for FHX50 display" ▪ Order code for FHX50 housing, feature 050 (device version): Option A "Prepared for FHX50 display" ▪ Order code for FHX50 housing, depends on the desired display module in feature 020 (display, operation): <ul style="list-style-type: none"> - Option C: for an SD02 display module (push buttons) - Option E: for an SD03 display module (touch control) <p>The FHX50 housing can also be ordered as a retrofit kit. The measuring device display module is used in the FHX50 housing. The following options must be selected in the order code for the FHX50 housing:</p> <ul style="list-style-type: none"> ▪ Feature 050 (measuring device version): option B "Not prepared for FHX50 display" ▪ Feature 020 (display, operation): option A "None, existing displayed used" <p> The FHX50 remote display cannot be combined with the order code for "Sensor version; DSC sensor; measuring tube":</p> <ul style="list-style-type: none"> ▪ option DA "Mass steam; 316L; 316L (integrated pressure/temperature measurement), -200 to +400 °C (-328 to +750 °F)" ▪ option DB "Mass gas/liquid; 316L; 316L (integrated pressure/temperature measurement), -40 to +100 °C (-40 to +212 °F)" <p> Special Documentation SD01007F</p> <p>(Order number: FHX50)</p>
Overvoltage protection for 2-wire devices	<p>Ideally, the overvoltage protection module should be ordered directly with the device. See product structure, characteristic 610 "Accessory mounted", option NA "Overvoltage protection". Separate order necessary only if retrofitting.</p> <ul style="list-style-type: none"> ▪ OVP10: For 1-channel devices (characteristic 020, option A): ▪ OVP20: For 2-channel devices (characteristic 020, options B, C, E or G) <p> Special Documentation SD01090F</p> <p>(Order number OVP10: 71128617) (Order number OVP20: 71128619)</p>
Protective cover	<p>Is used to protect the measuring device from the effects of the weather: e.g. rainwater, excess heating from direct sunlight or extreme cold in winter.</p> <p> Special Documentation SD00333F</p> <p>(Order number: 71162242)</p>

Accessories	Description
Connecting cable for remote version	<ul style="list-style-type: none"> ▪ Connecting cable available in various lengths: <ul style="list-style-type: none"> – 5 m (16 ft) – 10 m (32 ft) – 20 m (65 ft) – 30 m (98 ft) ▪ Reinforced cables available on request. <p> Standard length: 5 m (16 ft) Is always supplied if no other cable length has been ordered.</p>
Post mounting kit	<p>Post mounting kit for transmitter.</p> <p> The post mounting kit can only be ordered together with a transmitter.</p> <p>(Order number: DK8WM-B)</p>



For the sensor

Accessories	Description
Flow conditioner	<p>Is used to shorten the necessary inlet run.</p> <p>(Order number: DK7ST)</p>



Communication-specific accessories

Accessories	Description
Commubox FXA195 HART	<p>For intrinsically safe HART communication with FieldCare via the USB interface.</p> <p> Technical Information TI00404F</p>
Commubox FXA291	<p>Connects Endress+Hauser field devices with a CDI interface (= Endress+Hauser Common Data Interface) and the USB port of a computer or laptop.</p> <p> Technical Information TI405C/07</p>
HART Loop Converter HMX50	<p>Is used to evaluate and convert dynamic HART process variables to analog current signals or limit values.</p> <ul style="list-style-type: none"> ▪ Technical Information TI00429F ▪ Operating Instructions BA00371F
Wireless HART adapter SWA70	<p>Is used for the wireless connection of field devices.</p> <p>The WirelessHART adapter can be easily integrated into field devices and existing infrastructures, offers data protection and transmission safety and can be operated in parallel with other wireless networks with minimum cabling complexity.</p> <p> Operating Instructions BA00061S</p>
Fieldgate FXA320	<p>Gateway for the remote monitoring of connected 4-20 mA measuring devices via a Web browser.</p> <p> Technical Information TI00025S  Operating Instructions BA00053S</p>
Fieldgate FXA520	<p>Gateway for the remote diagnostics and remote configuration of connected HART measuring devices via a Web browser.</p> <p> Technical Information TI00025S  Operating Instructions BA00051S</p>
Field Xpert SFX350	<p>Field Xpert SFX350 is a mobile computer for commissioning and maintenance. It enables efficient device configuration and diagnostics for HART and FOUNDATION Fieldbus devices and can be used in non-hazardous areas.</p> <p> Operating Instructions BA01202S</p>
Field Xpert SFX370	<p>Field Xpert SFX370 is a mobile computer for commissioning and maintenance. It enables efficient device configuration and diagnostics for HART and FOUNDATION Fieldbus devices and can be used in the non-hazardous area and in the hazardous area.</p> <p> Operating Instructions BA01202S</p>

Service-specific accessories

Accessories	Description
Applicator	<p>Software for selecting and sizing Endress+Hauser measuring devices:</p> <ul style="list-style-type: none"> Choice of measuring devices for industrial requirements Calculation of all the necessary data for identifying the optimum flowmeter: e.g. nominal diameter, pressure loss, flow velocity and accuracy. Graphic illustration of the calculation results Determination of the partial order code, administration, documentation and access to all project-related data and parameters over the entire life cycle of a project. <p>Applicator is available:</p> <ul style="list-style-type: none"> Via the Internet: https://portal.endress.com/webapp/applicator As a downloadable DVD for local PC installation.
W@M	<p>W@M Life Cycle Management Improved productivity with information at your fingertips. Data relevant to a plant and its components is generated from the first stages of planning and during the asset's complete life cycle.</p> <p>W@M Life Cycle Management is an open and flexible information platform with online and on-site tools. Instant access for your staff to current, in-depth data shortens your plant's engineering time, speeds up procurement processes and increases plant uptime.</p> <p>Combined with the right services, W@M Life Cycle Management boosts productivity in every phase. For more information, visit www.endress.com/lifecyclemanagement</p>
FieldCare	<p>FDT-based plant asset management tool from Endress+Hauser. It can configure all smart field units in your system and helps you manage them. By using the status information, it is also a simple but effective way of checking their status and condition.</p> <p> Operating Instructions BA00027S and BA00059S</p>
DeviceCare	<p>Tool to connect and configure Endress+Hauser field devices.</p> <p> Innovation brochure IN01047S</p>

System components

Accessories	Description
Memograph M graphic data manager	<p>The Memograph M graphic data manager provides information on all the relevant measured variables. Measured values are recorded correctly, limit values are monitored and measuring points analyzed. The data are stored in the 256 MB internal memory and also on a SD card or USB stick.</p> <p> <ul style="list-style-type: none"> Technical Information TI00133R Operating Instructions BA00247R </p>
RN221N	<p>Active barrier with power supply for safe separation of 4-20 mA standard signal circuits. Offers bidirectional HART transmission.</p> <p> <ul style="list-style-type: none"> Technical Information TI00073R Operating Instructions BA00202R </p>
RNS221	<p>Supply unit for powering two 2-wire measuring devices solely in the non-hazardous area. Bidirectional communication is possible via the HART communication jacks.</p> <p> <ul style="list-style-type: none"> Technical Information TI00081R Brief Operating Instructions KA00110R </p>

Supplementary documentation

-  For an overview of the scope of the associated Technical Documentation, refer to the following:
- The *W@M Device Viewer* : Enter the serial number from the nameplate (www.endress.com/deviceviewer)
 - The *Endress+Hauser Operations App*: Enter the serial number from the nameplate or scan the 2-D matrix code (QR code) on the nameplate.

Standard documentation

Brief Operating Instructions

Brief Operating Instructions for the sensor

Measuring device	Documentation code
Prowirl F 200	KA01323D

Brief Operating Instructions for transmitter

Measuring device	Documentation code		
	HART	FOUNDATION Fieldbus	PROFIBUS PA
Proline 200	KA01326D	KA01327D	KA01328D

Operating Instructions

Measuring device	Documentation code		
	HART	FOUNDATION Fieldbus	PROFIBUS PA
Prowirl F 200	BA01686D	BA01694D	BA01690D

Description of Device Parameters

Measuring device	Documentation code		
	HART	FOUNDATION Fieldbus	PROFIBUS PA
Prowirl 200	GP01109D	GP01111D	GP01110D

Supplementary device-
dependent documentation

Safety Instructions

Contents	Documentation code
ATEX/IECEX Ex d, Ex tb	XA01635D
ATEX/IECEX Ex ia, Ex tb	XA01636D
ATEX/IECEX Ex ic, Ex ec	XA01637D
cCSA _{US} XP	XA01638D
cCSA _{US} IS	XA01639D
NEPSI Ex d	XA01643D
NEPSI Ex i	XA01644D
NEPSI Ex ic, Ex nA	XA01645D
INMETRO Ex d	XA01642D
INMETRO Ex i	XA01640D
INMETRO Ex nA	XA01641D
EAC Ex d	XA01684D
EAC Ex nA	XA01685D

Special documentation

Contents	Documentation code
Information on the Pressure Equipment Directive	SD01614D
Functional Safety Manual	SD02025D

Contents	Documentation code		
	HART	FOUNDATION Fieldbus	PROFIBUS PA
Heartbeat Technology	SD02029D	SD02030D	SD02031D
Wet steam detection	SD02032D	SD02033D	SD02034D
Wet steam measurement	SD02035D	SD02036D	SD02037D

Installation Instructions

Contents	Comment
Installation instructions for spare part sets and accessories	Documentation code: specified for each individual accessory → 95.

Registered trademarks

HART®

Registered trademark of the FieldComm Group, Austin, Texas, USA

PROFIBUS®

Registered trademark of the PROFIBUS User Organization, Karlsruhe, Germany

FOUNDATION™ Fieldbus

Registration-pending trademark of the FieldComm Group, Austin, Texas, USA

KALREZ®, VITON®

Registered trademarks of DuPont Performance Elastomers L.L.C., Wilmington, DE USA

GYLON®

Registered trademark of Garlock Sealing Technologies, Palmyra, NY, USA

www.addresses.endress.com
