

KELLER

*infrared
temperature
solutions*

ITS



NO1 in terms of
ACCURACY
RELIABILITY
INNOVATION

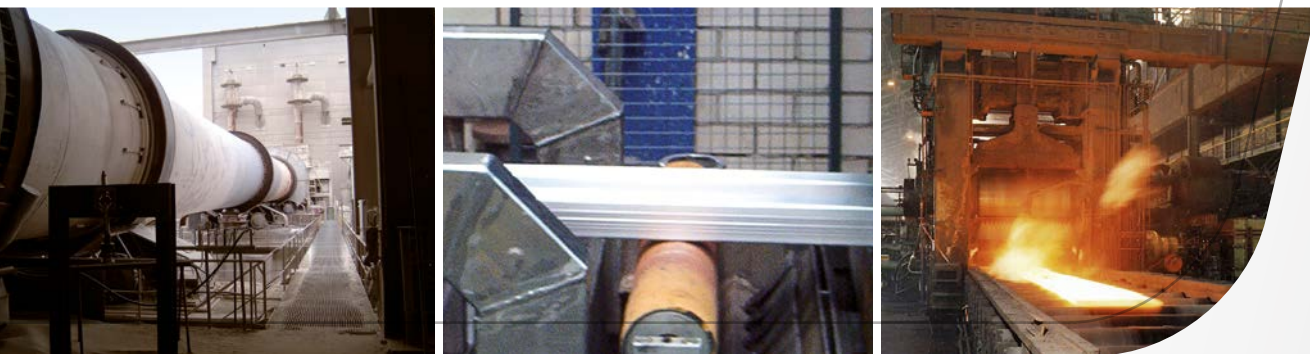

Pyrometer CellaTemp[®] PA

for non-contact temperature measurement
from 0 °C to + 3000 °C

Range of models

Compact pyrometer



Pyrometer with fibre optic cable and optical head



Single-colour pyrometer			
Model	Temperature range	Application	Shot shape
PA 10	0 - 1000 °C	nonmetals	○
PA 13	500 - 1600 °C	flame heating	○
PA 15	300 - 1300 °C	glass surfaces	○
	500 - 2500 °C		
PA 17	400 - 2000 °C	hot CO ₂ containing gases	○
PA 18	500 - 2500 °C	hot CO containing gases	○
PA 20	250 - 2000 °C	metals, ceramics, molten glass	○
	350 - 2500 °C		
PA 28	75 - 650 °C	aluminium; bright, shiny metal surfaces; laser applications	○
PA 29	150 - 800 °C	aluminium; bright, shiny metal surfaces; laser applications	○
	180 - 1200 °C		
	250 - 2000 °C		
PA 30	500 - 2500 °C	metals, ceramics, high temperatures	○
PA 35	600 - 3000 °C	precise measurement of metals, semiconductors	○

Single-colour pyrometer		
Model	Temperature range	Application
PA 21	300 - 2000 °C	metals, ceramics, molten glass
PA 31	550 - 2500 °C	metals, ceramics, high temperatures
PA 36	650 - 3000 °C	precise measurement of metals, semi-conductors

Two-colour pyrometer			
Model	Temperature range	Application	Shot shape
PA 40	500 - 1400 °C	metals, cement, lime, graphite, glass gobs, crystal pulling	○
	650 - 1700 °C		○
	750 - 2400 °C		○
	850 - 3000 °C		○
PA 43	600 - 1400 °C	wires, rods, heating coils, filaments	□
	650 - 1700 °C		□
	750 - 2400 °C		□
	850 - 3000 °C		□
PA 47	700 - 1700 °C	sooty flames	○
PA 50	500 - 1400 °C	metals at low temperatures	○
PA 60	300 - 800 °C	metals at very low temperatures	○

Two-colour pyrometer		
Model	Temperature range	Application
PA 41	700 - 1800 °C	metals, cement, lime, graphite, glass gobs, crystal pulling
	800 - 2400 °C	
	900 - 3000 °C	

Pyrometer CellaTemp® PA

Special Features

- Wide measuring ranges with high resolution
- Modular design: Electronics and optionally up to 5 optics
- Focusable optics
- 3 target sighting options: through-the-lens, colour video camera or laser spot light
- 2 analogue outputs, 2 switching outputs, inputs provide versatile configuration options
- Compact models and fibre optic models
- Two-colour and single-colour pyrometers
- Parameters adjustable via control keys
- USB and RS-485 bus interface
- SCM function for dirty window monitoring (two-color pyrometer)
- Option: ATD function (automatic temperature detection)

CellaTemp® PA Series

The CellaTemp® PA Pyrometer Series is based on a modular concept consisting of the following components: optics, sensor and signal processing, data output and target sighting.

The **optical system (1)** comprises one of five available objective lenses. Select the one most suitable, depending on the required target size and measuring distance. The pyrometer is infinitely adjustable to ensure superior precision across a wide focusing range.

The **aperture (2)** determines the shape of the measurement area. As a standard, the pyrometer features a circular measurement spot. As an option, the two-colour pyrometer models can be equipped with a rectangular measurement area.

A **sensor (3)** detects the IR radiation emitted by an object's surface. It is based on the latest DC technology and does not involve any moving parts. Depending on the specific model, CellaTemp® pyrometers are available either in a single-colour version (single wavelength detector) or in a two-colour version (dual wavelength detector).

Special **signal processing (4)** combined with high-resolution analogue-to-digital conversion enables a wide measuring span. The temperature resolution remains uniformly high across the entire measuring range.

For **measurement data output (5)**, CellaTemp® PA features 2 analogue outputs, a USB interface and a network compatible RS-485 interface as well as two switching outputs.

Three **target sighting (6)** systems are available to facilitate focusing, alignment and indication of spot size: through-the-lens sighting, laser spot light or an integrated video camera.



Analogue outputs

CellaTemp® PA features two analogue outputs which the user can custom configure. Two-colour pyrometers allow you to record the temperatures detected at each of the separate wavebands in addition to the ratio from these two signals (the two-colour temperature). Examining this data affords an analysis of the measured object's emissivity behaviour.

Analogue output 1 can be assigned to the current temperature reading, whereas output 2 can be programmed to perform another signal processing task such as maximum value, average value or to monitor the device's internal temperature.

Analogue input

Alternatively, the second analogue output can be configured as a signal input. This enables remote emissivity adjustment during running operations, either via PLC or when used together with the material selection switch VK 30.01.

Another possible use: to feed in the temperature signal from the radiation emitted by another source (as measured by another sensor). CellaTemp® PA can correct for the effect of this interfering radiation and thus produce readings of the true object temperature.

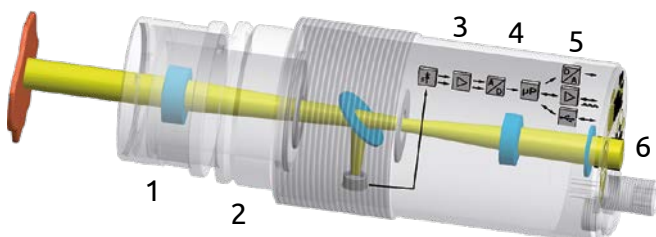

Switching outputs

CellaTemp® PA's two switching outputs provide a variety of configuration possibilities. They can be assigned to monitor a specific process temperature such as the device's internal temperature.

- The outputs function as a normally open or normally closed contacts
- This results in different application possibilities
- Monitor compliance with configured limit values
- Trigger a status indicator
- Synchronize data communication to the PLC

Switching inputs

Both switching outputs can also be operated as switching inputs for:

- Control memory reset command
- Activate the laser spot light

Data communication

The CellaTemp® PA features a USB interface and a network compatible RS-485 interface to enable remote pyrometer configuration. Beyond that, the RS-485 also provides network communication capabilities and permits long distance data transmission.

Because of its integrated software, the CellaTemp® PA can communicate with all commonly used operating systems at any PC or terminal, regardless of language.

The shipment includes the multilingual software CellaView for remote control, online display of the measurement curve, measurement analysis and storage of measured values.

Optics

A pyrometer is an optical means of measuring temperature. The quality of the optics greatly influences the the accuracy of the measurement. The „size of source effect“ is a factor which affects the uncertainty of the measurement. Light scattered into the optical path will result in false temperature data. When the target size or the distance to the target change, as shown in the chart, the temperature reading will change as well, depending on the quality of the optical system.

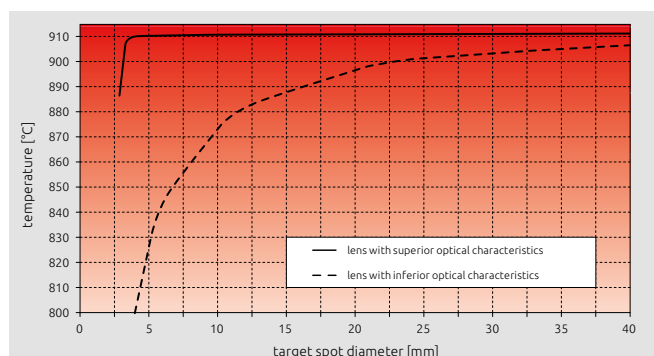

Influence of the size of the measured object on the temperature display with good and bad error correction of the optics of the pyrometer

CellaTemp® PA pyrometers feature an optical system which is optimized for the visible and infrared range. The superior glass lens features an antireflective coating. Due to its superior imaging properties, the high-precision lens provides consistently high optical resolution across the entire focusing range and a very small „size of source effect“.

In addition, the patented optics and apertures are mechanically designed to minimize sensitivity to light scattered into the sight path, so that the devices measure the same values even at different measuring distances.

Supplementary lenses

The CellaTemp® PA can capture target spots as small as Ø 0.3 mm when an additional lens is mounted.

The pyrometer models can be combined with supplementary lenses in a variety of ways, enabling additional optical resolutions for maximum versatility.



Dirty window monitor

Two-colour pyrometers feature SCM (Smart Contamination Monitoring), a function which indicates when the pyrometer lens or the protective quartz window are dirty.

The pyrometer identifies when the emitted IR energy does not completely reach the sensor due to obstructions in the line of sight or dirt buildup in the furnace port hole. The user can adjust the sensitivity of this function to a tolerated amount of signal attenuation.

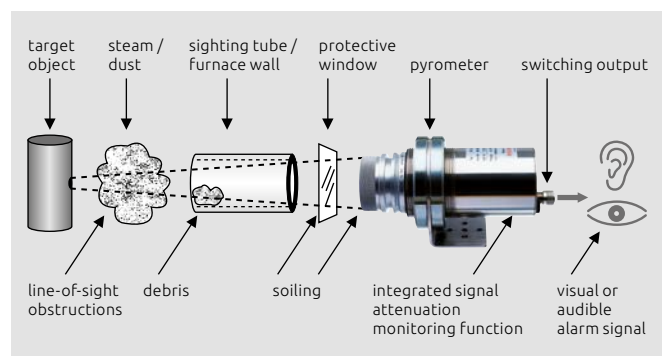

Indication of field-of-view obstruction

Sighting options for compact models



Through-the-lens

The CellaTemp® PA compact models can be supplied with through-the-lens, parallax-free sighting. The wide field of view makes it easy to focus on the target object. The ocular features a widened interpupillary distance, making it suitable for users who wear glasses or a helmet.



The circle in the viewfinder indicates the exact position and size of the measured target spot. If the target is especially bright, the polarizing filter PA 20/P can be mounted on the lens to protect the user's eye. For devices with a measuring range over 2000 °C, the filter is included as standard.



Laser spot light

The third sighting option available for CellaTemp® PA is an integrated laser spot light. The laser dot marks the center of the target spot and is well visible even from a distance of up to 10 m. The laser is activated either directly by push-button or remote by means of an external switch or via interface.

push-button or remote by means of an external switch or via interface.



Video camera

As an option, the pyrometer can be equipped with a built-in colour video camera to view the target. Based on the latest HDR (High Dynamic Range) technology, the camera provides a higher dynamic range from the imaging process and automatic exposure control. The video image appears without over-exposure and glare.

process and automatic exposure control. The video image appears without over-exposure and glare.

Another special feature is TBC (target brightness control). The light sensitivity adapts dynamically to the target object captured within the measurement spot to produce a high-contrast image of the target, regardless of whether the object focused on is cooler or hotter than the background.

The white balance can be switched to either „automatic“ or „daylight“ mode. The video signal also transmits the measurement data. The temperature reading is superimposed onto the screen. A separate PC is not required.

A video image allows you to observe possible changes in the micro-structure of the measured object relative to temperature. Because the video recording captures the temperature data in conjunction with the visible surface behaviour, it enables in-depth data analysis and process optimisation.

The target marker shown on the screen indicates the exact size of the measuring field. With a resolution of 5.6 µm / pixel, even the tiniest target objects are visible. The video signal is electrically isolated from the supply voltage to prevent noise that may interfere with the image signal. The camera provides reliable performance and a sharp image in ambient temperatures up to 65 °C.



Thanks to the automatic exposure control and the TBC feature, the target always appears in optimum exposure. The temperature reading and the circled target spot are superimposed onto the image.



Without TBC, the light exposure would be averaged over the total illumination. A bright target object in front of a dark background would appear overexposed as shown above.

Control keys

Parameters can be configured during running operations using the rear keypad. The large control keys are easy to access and operate. The brightly lit 8 mm digits on the LED display are visible from a great distance. Two status LEDs can be custom configured to indicate operating conditions.

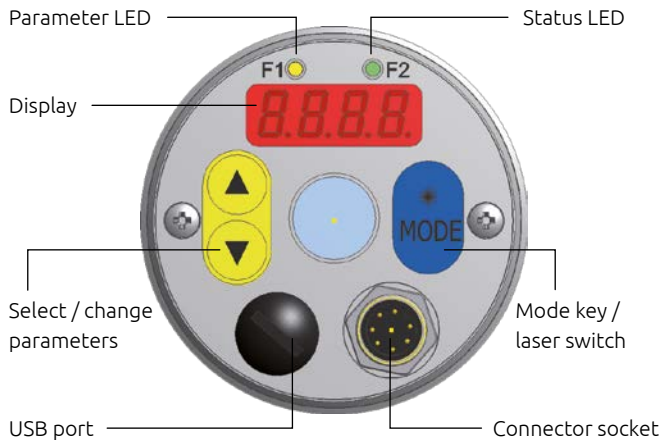

Adjustable parameters

- Temperature range
- Measured variable and scale of analog input and output signals
- Smoothing filter
- Min/max memory
- Hold time
- Emissivity
- Transmittance
- Background radiation correction
- Alarm contacts (mode and limits)
- ATD function parameters
- Linearization
- Function of LEDs
- Temperature scale °C / °F
- Simulation of current and temperature

In addition, for two-colour pyrometers

- One-colour/two-colour mode
- Signal attenuation threshold level
- Soot factor (at the CellaCombustion PA 47)

In addition, for model with camera

- TBC target brightness control
- White balance

Shipment includes

- Pyrometer CellaTemp® PA
- Connection cable VK 02/A (5 m)*
- Video cable VK 02/F (5 m)* for model with built-in camera
- USB cable VK 11/D (1.8 m)
- CellaView software
- Instruction manual

i * other lengths must be ordered separately

ATD function

ATD (Automatic Temperature Detection) is an optional feature especially useful for temperature control at discontinuous processes.

With ATD, objects moving across the pyrometer's field of view at undefined intervals are automatically detected. Examples include rolled steel slabs at a rolling mill stand or billets discharged from an induction heating system.

With ATD, CellaTemp® PA automatically recognizes a hot object and starts measuring the temperature. The measuring cycle either adapts dynamically to the duration of the object in the sight path, or it can be custom configured by the user. At the end of each measurement, a temperature reading is generated for each object.

Diagnostics feature

During setup and running operations, a test current or a temperature can be applied to perform diagnostic and simulation functions.

Without requiring a hot object in the field of view, it is possible to test the entire signal path to the transducer and to the control system.

Calibration for tungsten

Due to the physical properties of tungsten, its emissivity changes as a function of its temperature.

For tungsten filament applications, the CellaTemp® PA 40 can be calibrated with a special response curve for the behaviour of tungsten. This calibration option enables the pyrometer to correct for any temperature-induced emissivity changes.

Connection diagram

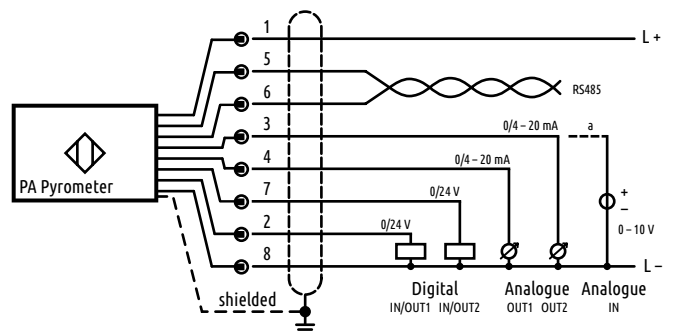

EMV standard

- EN 61000-6-4
- EN 61000-6-2
- EN 61000-4-2/ -3 / -4 / -6
- EN 55011

Software CellaView



The CellaView software is included in the scope of delivery. It is a Microsoft SQL server-based database software running under Windows designed for real-time graphic display, analysis and storage of the measurement readings. Monitoring, remote control

and configuration of the pyrometer are additional features of this software. The modern MDI-based user interface makes it possible to open multiple graphs at the same time. The series of measurements of up to 31 instruments can be recorded simultaneously.

- Windows-based multiple-document interface (MDI)
- Microsoft SQL Server Compact-based database
- Graphic display, recording and logging of measurement data
- Free selection and combination of the measurement readings and status information of up to 31 devices in one or more diagrams
- Simultaneous start of any number of diagrams to record series of measurements in parallel

- Configuration of the cycle duration for data logging and independent archiving
- Parameter setting, calibration and remote control of the pyrometers
- Saving, loading and transferring of configuration profiles of the devices
- Filtering function to reduce data volume
- Automatic device search
- Permanent connection monitoring
- Automatic archiving of the series of measurements
- Tamper-proof storage of the series of measurements
- Optional data storage in CSV format for subsequent handling in Excel
- Zoom, scroll and analysis functions
- Cursor to display the temperature and the time on the measurement curve
- Very fast data recording (milliseconds)
- Logging of user entries in a log file to check for configuration changes
- Download and software update via Internet
- No license restriction
- Runs under Windows XP, Vista, 7, 8, 10
- 9 languages selectable

Single-colour pyrometer

Model			Technical data								
Target sighting	Through-the-lens	Video camera	Laser spot light	Temp. range	Wave-length	Lens system	Focus range	Distance ratio	Response time t ₉₈	Precision*	Reproducibility
AF 1	AF 1/C	AF 1/L	0 - 1000 °C 32 - 1832 °F	8 - 14 μm	PZ 10.01	0.30 m - ∞	50 : 1	≤ 30 ms	1 % of reading, min. 2 K based on 30 ms	1 K	
AF 2	AF 2/C	AF 2/L			PZ 10.05	0.15 m - 0.30 m	48 : 1				
PA 20 ...	For metallic surfaces, ceramics, liquid glass at medium temperature range										
AF 1	AF 1/C	AF 1/L	250 - 2000 °C 482 - 3632 °F	1.1 - 1.7 μm	PZ 20.01	0.40 m - ∞	175 : 1	≤ 50 ms (T>250 °C) ≤ 2 ms (T>750 °C)	0.3 % of reading, min. 4 K	1 K	
AF 2	AF 2/C	AF 2/L			PZ 20.03	0.20 m - 0.40 m	150 : 1				
AF 3	AF 3/C	AF 3/L			PZ 20.06	1.20 m - ∞	275 : 1				
AF 4	AF 4/C	AF 4/L			PZ 20.05	0.20 m - ∞	40 : 1				
AF 9	AF 9/C	AF 9/L			PA 20.06	0.60 m - ∞	380 : 1				
AF 5	AF 5/C	AF 5/L	350 - 2500 °C 662 - 4532 °F		PZ 20.01	0.40 m - ∞	175 : 1				
AF 6	AF 6/C	AF 6/L			PZ 20.03	0.20 m - 0.40 m	150 : 1				
AF 7	AF 7/C	AF 7/L			PZ 20.06	1.20 m - ∞	275 : 1				
AF 8	AF 8/C	AF 8/L			PZ 20.05	0.20 m - ∞	40 : 1				
PA 30 ...	For metallic surfaces, ceramics, liquid glass at high temperature range										
AF 1	AF 1/C	AF 1/L	500 - 2500 °C 932 - 4532 °F	0.78 - 1.06 μm	PZ 20.01	0.40 m - ∞	210 : 1	≤ 50 ms (T>550 °C) ≤ 2 ms (T>750 °C)	0.3 % of reading, min. 4 K	1 K	
AF 2	AF 2/C	AF 2/L			PZ 20.03	0.20 m - 0.40 m	200 : 1				
AF 3	AF 3/C	AF 3/L			PZ 20.06	1.20 m - ∞	310 : 1				
AF 4	AF 4/C	AF 4/L			PZ 20.05	0.20 m - ∞	55 : 1				
AF 5	AF 5/C	AF 5/L			PA 20.06	0.60 m - ∞	430 : 1				

*(at ε = 1 and Ta = +23 °C)

Pyrometers for special applications

CellaTemp® PA 13



The CellaTemp® PA 13 was especially developed for temperature measurements in flame heated furnaces. Thanks to the selective spectral range of 3.9 μm , water vapour and CO_2 existing in the pyrometer's field of vision have no effect on the measuring results,

even when measuring from large distances. This allows precise measurements through flames and combustion gases.

CellaTemp® PA 15

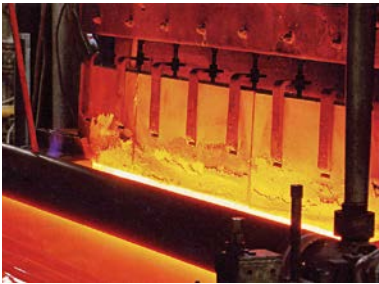

In the range of 4.6-4.9 μm glass has an emissivity of almost 100%. Above 5 μm , atmospheric influences, such as humidity or water vapour, affect the measurement.

The CellaTemp® PA 15 is provided with a blocking filter with a spectral sensitivity of 4.6-4.9 μm , thus measuring the temperature from the near surface area of the glass. Owing to the wavelength used, changes in thickness, different types of glass or varying moisture contents in the atmosphere do not affect the measurement reading.

CellaCombustion PA 17

The CellaCombustion PA 17 uses a specific wavelength, in which hot carbonaceous gases have a high optical density and therefore good radiation properties. The pyrometers are used to measure the exhaust gas temperature in gas-fired boilers and small combustion plants.

CellaCombustion PA 18

The CellaCombustion PA 18 uses a specific wavelength, in which the chemical components of the hot combustion gas have a high optical density. The devices are used in large combustion plants such as thermal waste-disposal plants and coal power plants.

CellaTemp® PA 28

The CellaTemp® PA 28 is equipped with a light-intense lens and a special sensor for the reliable low temperature measuring of metals.

CellaTemp® PA 29

CellaTemp® PA 29 was designed with a special band-stop filter and sensor which ignore interfering IR radiation from sources such as daylight or laser beams.

CellaTemp® PA 29 features a response spectrum which is far less sensitive to incidental light reflections from nearby hot objects than most commonly available pyrometers which are responsive at short wavelengths. The individual components and subassemblies can be combined in different ways, yielding 24 instrument variants. In combination with supplementary lenses the CellaTemp® PA 29 can capture target spots as small as $\varnothing 0.3 \text{ mm}$.



Due to the wide temperature ranges and the variety of available optics, the CellaTemp® PA 29 provides maximum versatility. It is suitable for various applications in the metalworking industry, and is ideal for measuring reflective metals and aluminium at low temperatures.

With its band-stop filter, the CellaTemp® PA 29 is highly accurate in capturing the temperature of metal surfaces which are heat-treated by diode, Nd:YAG or CO_2 lasers without being effected by the extremely high laser energy.

CellaTemp® PA 35

The CellaTemp PA 35 features a narrow-band, short wavelength spectral response to minimize the effect of interferences which lead to measurement errors. Detectors which respond to narrow wavebands at short wavelengths are far less susceptible to fluctuating emissivity or signal attenuation due to sight path obstructions such as dust, steam, smoke or a dirty lens.

Metal surfaces, for example, exhibit higher emissivity at shorter wavelengths and at higher temperatures. Due to the special wavelength, CellaTemp PA 35 is especially suitable for temperature detection of metals and high-temperature applications. The pyrometer's specific spectral sensitivity is also ideal for the silicon wafer production process. Silicon is transparent at wavelengths $> 1 \mu\text{m}$. Standard pyrometers will see through the silicon surface and detect the temperature of the material behind it.

CellaCombustion PA 47

The CellaCombustion PA 47 is a special pyrometer for non-contact temperature measurement of sooty flames in coal power plants or waste incineration plants. The measurement and signal processing based on the two-colour method detects the heat radiation of the sooty particles of the flame in the near infrared range at two wavelengths. The burn-out operation can be controlled by the flame temperature to reduce the pollutant emission and to minimize the slagging of the walls in the combustion chamber.

Pyrometers for special applications

Model			Technical data							
Target sighting			Temp. range	Wave-length	Lens system	Focus range	Distance ratio	Response time t_{98}	Precision*	Repro-ducibility
Through-the-lens	Video camera	Laser spot light								
PA 13 ...			For measurements in combustion plants and flame-heated furnaces							
AF 1	AF 1/C	AF 1/L	500 - 1600 °C 932 - 2912 °F	3.9 µm	PZ 15.03	0.80 m - ∞	45 : 1	≤ 100 ms	1 % of reading	2 K
PA 15 ...			For glass surfaces							
AF 1	AF 1/C	AF 1/L	500 - 2500 °C 932 - 4532 °F	4.6 - 4.9 µm	PZ 15.03	0.80 m - ∞	70 : 1	≤ 100 ms	0.75 % of reading	2 K
AF 2	AF 2/C	AF 2/L	300 - 1300 °C 572 - 2372 °F		PZ 15.03	0.80 m - ∞	45 : 1		0.75 % of reading, min. 3 K	
PA 17 ...			For measurements in environments with hot, CO ₂ -containing gases (e.g. in gas-fired boilers and small combustion plants)							
AF 1	AF 1/C	—	400 - 2000 °C 752 - 3632 °F	CO ₂ range	PZ 15.03	0.80 m - ∞	75 : 1	≤ 100 ms	0.75 % of reading + 1 K	2 K
PA 18 ...			For measurements in environments with hot, CO-containing gases (e.g. in thermal waste-disposal plants and coal power plants)							
AF 1	AF 1/C	—	500 - 2500 °C 932 - 4532 °F	CO range	PZ 15.03	0.80 m - ∞	70 : 1	≤ 100 ms	0.75 % of reading	2 K
PA 28 ...			For measurements of aluminium, polished metal surfaces and laser applications							
AF 10	AF 10/C	AF 10/L	75 - 650 °C 167 - 1202 °F	1.8 - 2.4 µm	PZ 20.08	0.30 m - ∞	48 : 1	≤ 200 ms (T>75 °C) ≤ 50 ms (T>100 °C) ≤ 15 ms (T>125 °C) ≤ 2 ms (T>200 °C)	0.75 % of reading, min. 3 K	1 K
PA 29 ...			For measurements of aluminium, polished metal surfaces and laser applications							
AF 10	AF 10/C	AF 10/L	150 - 800 °C 302 - 1472 °F	1.8 - 2.2 µm	PZ 20.08	0.30 m - ∞	48 : 1	≤ 50 ms (T>150 °C) ≤ 15 ms (T>200 °C) ≤ 2 ms (T>350 °C)	0.75 % of reading, min. 5 K	1 K
AF 21	AF 21/C	AF 21/L	180 - 1200 °C 356 - 2192 °F		PZ 20.01	0.40 m - ∞	60 : 1	≤ 75 ms (T>180 °C) ≤ 35 ms (T>200 °C) ≤ 5 ms (T>300 °C)		
AF 22	AF 22/C	AF 22/L			PZ 20.03	0.20 m - 0.40 m	56 : 1	≤ 2 ms (T>600 °C)		
AF 23	AF 23/C	AF 23/L			PZ 20.06	1.20 m - ∞	96 : 1	≤ 2 ms (T>600 °C)		
AF 1	AF 1/C	AF 1/L	250 - 2000 °C 482 - 3632 °F		PZ 20.01	0.40 m - ∞	210 : 1	≤ 50 ms (T>250 °C)	0.5 % of reading, min. 4 K	
AF 2	AF 2/C	AF 2/L			PZ 20.03	0.20 m - 0.40 m	200 : 1	≤ 2 ms (T>750 °C)		
AF 3	AF 3/C	AF 3/L			PZ 20.06	1.20 m - ∞	310 : 1			
AF 4	AF 4/C	AF 4/L		PZ 20.05	0.20 m - ∞	55 : 1				
PA 35 ...			For the precise measurement of metals, very high temperatures and semiconductors							
AF 1	AF 1/C	AF 1/L	600 - 3000 °C 1112 - 5432 °F	0.82 - 0.93 µm	PZ 20.01	0.40 m - ∞	210 : 1	≤ 50 ms (T>650 °C) ≤ 2 ms (T>850 °C)	0.3 % of reading, min. 4 K	1 K
AF 2	AF 2/C	AF 2/L			PZ 20.03	0.20 m - 0.40 m	200 : 1			
AF 3	AF 3/C	AF 3/L			PZ 20.06	1.20 m - ∞	310 : 1			
AF 4	AF 4/C	AF 4/L			PZ 20.05	0.20 m - ∞	55 : 1			
AF 5	AF 5/C	AF 5/L			PA 20.06	0.60 m - ∞	430 : 1			
PA 47 ...			For the measurement of sooty flames (e.g. in power plants or incineration plants)							
AF 1	AF 1/C	—	700 - 1700 °C 1292 - 3092 °F	0.8/1.05 µm	PZ 20.01	0.40 m - ∞	80 : 1	≤ 20 ms (T>650 °C) ≤ 10 ms (T>750 °C)	1 % of reading	2 K

*(at $\epsilon = 1$ and $T_a = +23$ °C)

Compact two-colour pyrometer

The two-colour pyrometer detects the infrared radiation emitted from an object's surface at two separate wavelengths. The dual sandwich detector uses a two-element photo-diode to capture both radiation intensities simultaneously from the exact same spot. The pyrometer produces temperature data based on the ratio of these two intensities. The advantage of the two-colour or dual wavelength technique is that the pyrometer will still produce highly accurate temperature data, even at signal attenuation of up to 90%. The two-colour or ratio pyrometer is far less sensitive to contaminants in the line of sight such as steam, dust or smoke than a standard single-colour pyrometer. Even if other sources impair the visibility such as dirt on the pyrometer lens or sediment and debris buildup within the sight tube, it has up to a certain degree no influence on the measurement value. When the signal is equally attenuated at both wavelengths, this will have no impact on the accuracy of the temperature reading. The two-colour method enables the pyrometer to correct for measurement errors which would otherwise occur when a material's emissivity varies as a function of temperature or surface properties, or when the pyrom-

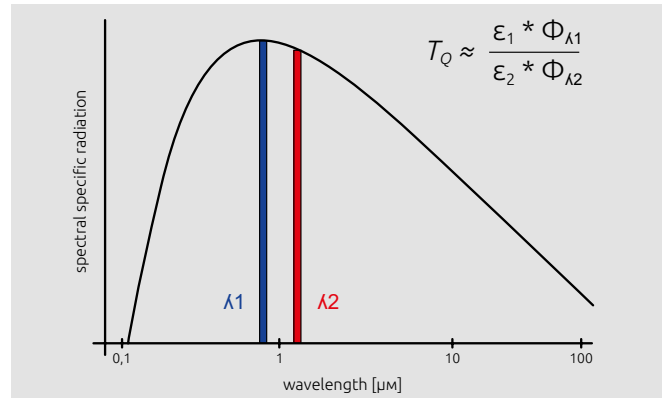

eter is used at a production line which produces a variety of products having different emissivities.

Model			Technical data							Precision*	Reproducibility
Target sighting			Temp. range	Wave-length	Lens system	Focus range	Distance ratio	Response time t ₉₈			
Through-the-lens	Video camera	Laser spot light									
PA 40 ...			For use in these industries: steel, ceramics or cement in harsh environments								
AF 20	AF 20/C	AF 20/L	500 - 1400 °C 932 - 2552 °F	0.95/ 1.05 µm	PZ 20.08	0.30 m - ∞	55 : 1	≤ 10 ms (T>650 °C)	1 % of reading	2 K	
AF 1	AF 1/C	AF 1/L			650 - 1700 °C 1202 - 3092 °F	PZ 20.01	0.40 m - ∞				80 : 1
AF 2	AF 2/C	AF 2/L	PZ 20.03			0.20 m - 0.40 m	75 : 1				
AF 3	AF 3/C	AF 3/L	PZ 20.06			1.20 m - ∞	120 : 1				
AF 10	AF 10/C	AF 10/L	PZ 20.05			0.20 m - ∞	20 : 1				
AF 13	AF 13/C	AF 13/L	PZ 20.08			0,30 m - ∞	55 : 1				
AF 21	AF 21/C	AF 21/L	PA 20.06			0.60 m - ∞	190 : 1				
AF 4	AF 4/C	AF 4/L	750 - 2400 °C 1382 - 4532 °F		PZ 20.01	0.40 m - ∞	150 : 1	≤ 10 ms (T>950 °C)			
AF 5	AF 5/C	AF 5/L			PZ 20.03	0.20 m - 0.40 m	140 : 1				
AF 6	AF 6/C	AF 6/L			PZ 20.06	1.20 m - ∞	240 : 1				
AF 11	AF 11/C	AF 11/L		PZ 20.05	0.20 m - ∞	35 : 1					
AF 14	AF 14/C	AF 14/L		PZ 20.08	0,30 m - ∞	100 : 1					
AF 22	AF 22/C	AF 22/L		PA 20.06	0.60 m - ∞	370 : 1					
AF 7	AF 7/C	AF 7/L		850 - 3000 °C 1562 - 5432 °F	PZ 20.01	0.40 m - ∞	150 : 1		≤ 10 ms (T>1050 °C)		
AF 8	AF 8/C	AF 8/L			PZ 20.03	0.20 m - 0.40 m	140 : 1				
AF 9	AF 9/C	AF 9/L			PZ 20.06	1.20 m - ∞	240 : 1				
AF 12	AF 12/C	AF 12/L			PZ 20.05	0.20 m - ∞	35 : 1				
AF 15	AF 15/C	AF 15/L	PZ 20.08		0,30 m - ∞	100 : 1					
AF 18	AF 18/C	AF 18/L	PA 40.01		86 mm - 115 mm	250 : 1					
AF 23	AF 23/C	AF 23/L	PA 20.06		0.60 m - ∞	370 : 1					
PA 50 ...			For measurements of materials with varying emissivity								
AF 1	AF 1/C	AF 1/L	500 - 1400 °C 932 - 2552 °F	0.95/ 1.55 µm	PZ 20.01	0.40 m - ∞	80 : 1	≤ 30 ms	1 % of reading	2 K	
AF 2	AF 2/C	AF 2/L			PZ 20.03	0.20 m - 0.40 m	75 : 1				
AF 3	AF 3/C	AF 3/L			PZ 20.06	1.20 m - ∞	120 : 1				
AF 4	AF 4/C	AF 4/L			PZ 20.05	0.20 m - ∞	20 : 1				
PA 60 ...			For measurements at low temperatures from 300 °C								
AF 1	AF 1/C	AF 1/L	300 - 800 °C 572 - 1472 °F	1.5/ 1.9 µm	PZ 20.08	0.30 m - ∞	39 : 1	≤ 30 ms	1 % of reading	2 K	
AF 11	AF 11/C	AF 11/L			400 - 1000 °C 752 - 1832 °F	PZ 20.01	0.40 m - ∞				60 : 1

*(at ε = 1 and T_a = +23 °C)

Panorama pyrometer® with rectangular measurement area

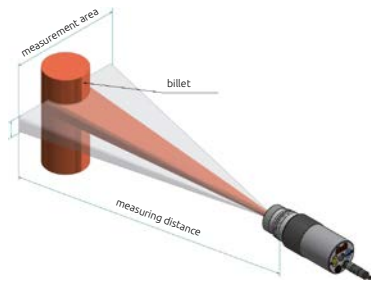

The CellaTemp® PA 43, a panorama pyrometer®, features a rectangular measurement area. The unique design enables the pyrometer to detect the temperature of target objects which move within the rectangular area. This is accomplished without requiring any moving parts.

The CellaTemp® PA 43 reliably captures objects which typically show fluctuating behaviour (such as swaying wires). The rectangular area is also ideal when measuring objects whose position tends to vary during the production process. Such objects include billets or metal rods at a roller table.

A rectangular measurement field simplifies pyrometer alignment and focusing in applications which involve small measurement objects. The pyrometer models can be combined with supplementary lenses for very small targets such as filaments.

Model			Technical data							
Through-the-lens	Video camera	Laser spot light	Temp. range	Wave-length	Lens system	Focus range	Distance ratio	Response time t_{98}	Precision*	Reproducibility
AF 20	AF 20/C	AF 20/L	600 - 1400 °C 1112 - 2552 °F	0.95/ 1.05 μm	PZ 20.08	0.30 m - ∞	$D_v = 150 : 1$ $D_h = 30 : 1$	≤ 10 ms (T>650 °C)	1.5 % of reading	3 K
AF 1	AF 1/C	AF 1/L	650 - 1700 °C 1202 - 3092 °F		PZ 20.01	0.40 m - ∞	$D_v = 230 : 1$ $D_h = 45 : 1$			
AF 2	AF 2/C	AF 2/L			PZ 20.03	0.20 m - 0.40 m	$D_v = 215 : 1$ $D_h = 40 : 1$			
AF 3	AF 3/C	AF 3/L			PZ 20.06	1.20 m - ∞	$D_v = 375 : 1$ $D_h = 75 : 1$			
AF 10	AF 10/C	AF 10/L			PZ 20.05	0.20 m - ∞	$D_v = 55 : 1$ $D_h = 10 : 1$			
AF 13	AF 13/C	AF 13/L			PZ 20.08	0.30 m - ∞	$D_v = 150 : 1$ $D_h = 30 : 1$			
AF 21	AF 21/C	AF 21/L			PA 20.06	0.60 m - ∞	$D_v = 500 : 1$ $D_h = 95 : 1$			
AF 4	AF 4/C	AF 4/L			750 - 2400 °C 1382 - 4532 °F	PZ 20.01	0.40 m - ∞	$D_v = 350 : 1$ $D_h = 50 : 1$		
AF 5	AF 5/C	AF 5/L	PZ 20.03			0.20 m - 0.40 m	$D_v = 330 : 1$ $D_h = 45 : 1$			
AF 6	AF 6/C	AF 6/L	PZ 20.06			1.20 m - ∞	$D_v = 580 : 1$ $D_h = 85 : 1$			
AF 11	AF 11/C	AF 11/L	PZ 20.05			0.20 m - ∞	$D_v = 85 : 1$ $D_h = 11 : 1$			
AF 14	AF 14/C	AF 14/L	PZ 20.08			0.30 m - ∞	$D_v = 230 : 1$ $D_h = 34 : 1$			
AF 17	AF 17/C	AF 17/L	PA 40.01			86 mm - 115 mm	$D_v = 380 : 1$ $D_h = 80 : 1$			
AF 22	AF 22/C	AF 22/L	PA 20.06			0.60 m - ∞	$D_v = 730 : 1$ $D_h = 105 : 1$			
AF 7	AF 7/C	AF 7/L	850 - 3000 °C 1562 - 5432 °F	PZ 20.01	0.40 m - ∞	$D_v = 350 : 1$ $D_h = 50 : 1$	≤ 10 ms (T>1050 °C)			
AF 8	AF 8/C	AF 8/L		PZ 20.03	0.20 m - 0.40 m	$D_v = 330 : 1$ $D_h = 45 : 1$				
AF 9	AF 9/C	AF 9/L		PZ 20.06	1.20 m - ∞	$D_v = 580 : 1$ $D_h = 85 : 1$				
AF 12	AF 12/C	AF 12/L		PZ 20.05	0.20 m - ∞	$D_v = 85 : 1$ $D_h = 11 : 1$				
AF 15	AF 15/C	AF 15/L		PZ 20.08	0.30 m - ∞	$D_v = 230 : 1$ $D_h = 34 : 1$				
AF 18	AF 18/C	AF 18/L		PA 40.01	86 mm - 115 mm	$D_v = 380 : 1$ $D_h = 80 : 1$				
AF 23	AF 23/C	AF 23/L		PA 20.06	0.60 m - ∞	$D_v = 730 : 1$ $D_h = 105 : 1$				

*(at $\epsilon = 1$ and $T_a = +23$ °C)

Single-colour / two-colour fibre optics pyrometer



A pyrometer with fibre optics has the sensor head housed separately from the electronics assembly. A fibre optic cable transmits the detected infrared energy to the electronics. The optical sensor head can withstand ambient temperatures up

to 250 °C without cooling. Both the sensor head and the fibre optic cable are unsusceptible to electromagnetic radiation. Pyrometers with fibre optics are ideal for cramped, hard-to-access locations. Three different focusable optical heads are available. Select the one most suitable, depending on the required target size and measuring distance.

For target sighting and focussing, the pyrometer features a built-in laser spot light. Laser sighting can be activated either by remote switch, using the control keys on the instrument, or via interface.

The optical fibre can be supplied at a length of up to 50 m, ensuring that the electronics can be installed at a safe distance. The fibre optic cable is equipped with a screw connector at each end to ease installation and detachment. Metallic armouring provides the optical fibre with a high degree of mechanical protection.



PA 41.../V devices with two optical fibers and vacuum feedthrough

Model	Technical data								
Type	Temp. range	Wave-length	Lens system	Focus range	Distance ratio	Method	Response time t_{98}	Precision*	Reproducibility
PA 21 ...	For metallic surfaces, ceramics, liquid glass at medium temperature range								
AF 11	300 - 2000 °C 572 - 3632 °F	1.1 - 1.7 µm	PA 41.01	0.20 m - ∞	180 : 1	single-colour	≤ 50 ms (T>300 °C)	0.75 % of reading, min. 4 K	2 K
AF 21			PZ 41.05	0.12 m - ∞	100 : 1		≤ 2 ms (T>800 °C)		
AF 22			PZ 41.18	33 mm - 45 mm	50 : 1		≤ 50 ms (T>450 °C)		
AF 901	450 - 2500 °C 842 - 4532 °F		PA 41.02	0.50 m - ∞	320 : 1		≤ 2 ms (T>900 °C)		
PA 31 ...	For metallic surfaces, ceramics, liquid glass at high temperature range								
AF 11	550 - 2500 °C 1022 - 4532 °F	0.78 - 1.06 µm	PA 41.01	0.20 m - ∞	190 : 1	single-colour	≤ 50 ms (T>600 °C)	0.75 % of reading	2 K
AF 21			PZ 41.05	0.12 m - ∞	100 : 1		≤ 2 ms (T>800 °C)		
AF 22			PZ 41.18	33 mm - 45 mm	50 : 1		≤ 50 ms (T>750 °C)		
AF 901	700 - 3000 °C 1292 - 5432 °F		PA 41.02	0.50 m - ∞	340 : 1		≤ 2 ms (T>950 °C)		
PA 36 ...	For the precise measurement of metals, very high temperatures and semiconductors								
AF 11	650 - 3000 °C 1202 - 5432 °F	0.82 - 0.93 µm	PA 41.01	0.20 m - ∞	190 : 1	single-colour	≤ 50 ms (T>680 °C)	0.75 % of reading	2 K
AF 21			PZ 41.05	0.12 m - ∞	100 : 1		≤ 2 ms (T>900 °C)		
AF 22			PZ 41.18	33 mm - 45 mm	50 : 1				
PA 41 ...	For use in these industries: steel, ceramics or cement in harsh environments								
AF 211	700 - 1800 °C 1292 - 3272 °F	0.95 - 1.05 µm	PA 41.01	0.20 m - ∞	110 : 1	two-colour	≤ 20 ms (T>850 °C)	1.5 % of reading	3 K
AF 221			PZ 41.05	0.12 m - ∞	50 : 1		≤ 20 ms (T>950 °C)		
AF 222			PZ 41.18	33 mm - 45 mm	36 : 1				
AF 222/V			PZ 41.18	33 mm - 45 mm	36 : 1				
AF 11	800 - 2400 °C 1472 - 4352 °F		PA 41.01	0.20 m - ∞	190 : 1	two-colour	≤ 20 ms (T>1050 °C)	1.5 % of reading	3 K
AF 21		PZ 41.05	0.12 m - ∞	100 : 1					
AF 22		PZ 41.18	33 mm - 45 mm	50 : 1					
AF 22/V			PZ 41.18	33 mm - 45 mm	50 : 1				
AF 111	900 - 3000 °C 1652 - 5432 °F		PA 41.01	0.20 m - ∞	190 : 1	two-colour	≤ 20 ms (T>1350 °C)	1.5 % of reading	3 K
AF 111/V		PA 41.01	0.20 m - ∞	190 : 1					
AF 121		PZ 41.05	0.12 m - ∞	100 : 1					
AF 122			PZ 41.18	33 mm - 45 mm	50 : 1				
AF 901	1100 - 3000 °C 2012 - 5432 °F		PA 41.02	0.50 m - ∞	340 : 1				

* (at $\epsilon = 1$ and $T_a = +23$ °C)

Accessories



Shielded cable
VK 02/A AF 1: 5 m
VK 02/A AF 2: 10 m
VK 02/A AF 3: 20 m

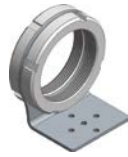

Mounting bracket
with 2 shaft nuts
PA 11/U



Mounting angle,
adjustable
PA 11/K



Clamping collar
PZ 20/L: Ø 70 mm
PZ 20/N: Ø 65 mm



Pedestal mount
PB 08/K



Air purge
PZ 20/A



ZnS window PA 10/I
Sapphire window PA 15/I
Quartz window PA 20/I



Quick connector with window
PA 10/C (ZnS)
PA 15/C (Sapphire)
PA 20/C (Quartz)

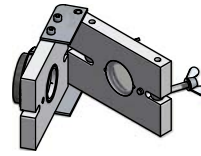

Window with hinge
PZ 10/I (ZnS)
PZ 15/I (CaF₂)
PZ 20/I (Quartz)



Mounting with flange
PB 08/Q AF1 (Mounting)
PB 08/R AF1 (Flange)

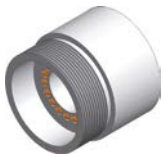

Illumination ring
PZ 10/P



Ball flange
PB 08/I



Intermediate tube
PZ 20/C

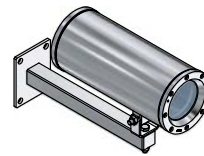

Ex proof enclosure
PZ 40/N AF1



Protective enclosure,
open PA 40/B



Protective enclosure
closed PA 40/M



Cooling jacket, open
PA 20/B



Cooling jacket, closed
PA 20/M



Cooling jacket PA 20/M
AF2 for pyrometer
with camera

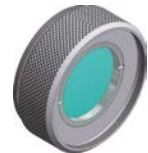

Supplementary lens
PZ 20/O



Protective glass
PZ 10/I AF 1 (ZnS)
70146 (Quartz)



Junction box with
material selection switch
VK 30.01

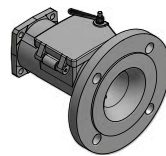

Flange tube
PB 08/M AF1

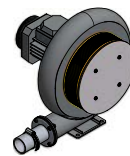

Fan
PB 08/F AF4



Connection head
PB 08/N



Mirror attachment 90°
PA 20/E



Dust stop
PZ 10/T (35 mm)
PZ 20/T (20 mm)



Intermediate tube
with socket
PZ 40/C



Intermediate tube
PZ 20/J



Flange
PZ 20/F

Mountings

Mounting PA 20-006

consisting of:

- Air purge PZ 20/A
- Intermediate tube PZ 20/J
- Mounting bracket PA 11/U
- Mounting angle, adjustable PA 11/K

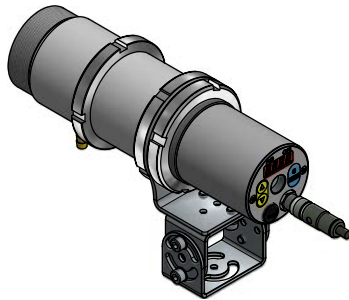

Mounting PA 83-010 for pedestal mount

consisting of:

- Dust stop PZ 10/T
- Intermediate tube PZ 20/C
- Air purge PZ 20/A
- Clamping collar PZ 20/L AF 2
- Cooling jacket, closed PA 20/I
- Hose nozzle G1/8"
- Mounting PB 08/Q AF 1
- Flange PB 08/R AF 1

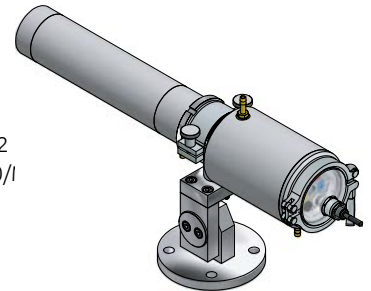

Mounting PA 20-027 for furnace installation

consisting of:

- Cooling jacket PA 20/M AF 1
- Quartz window with hinge PZ 20/I
- Air purge PZ 20/A
- Intermediate tube PZ 20/C
- Mounting flange PZ 20/F
- Dust stop PZ 20/S
- Ball flange PB 08/I

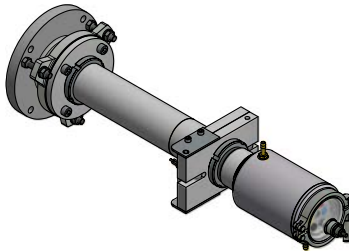

Mounting PA 20-077 for hot blast stoves

consisting of:

- Cooling jacket, closed PA 20/M AF 2
- Flange PB 08/O
- Flange tube PB 08/M AF 1

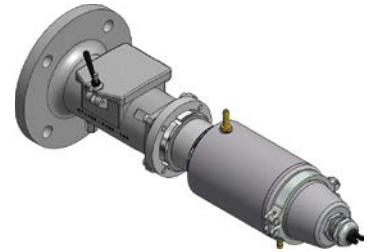

Mounting PA 20-065 for compressed air for the cement industry

consisting of:

- Cooling jacket PA 20/M AF 1
- Quartz window with hinge PZ 20/I
- Air purge PZ 20/A
- Intermediate tube PZ 20/C
- Flange PZ 20/F
- Dust stop PZ 20/S
- Ball flange PB 08/I
- Hose clamp 10-16 mm
- Industrial hose GP40
- Mounting plate in wall housing SK 613 with flow monitor

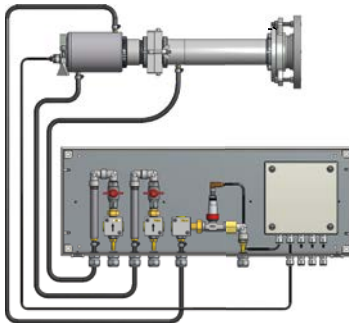

Mounting PA 20-066 fan air for the cement industry

consisting of:

- Cooling jacket PA 20/M AF 1
- Quartz window with hinge PZ 20/I
- Intermediate tube with socket PZ 40/C
- Flange PZ 20/F
- Ball flange PB 08/I
- Fan PB 08/F AF 3
- Aluminium hose PB 08/L
- Hose clamps 10-16 mm and 50-70 mm
- Industrial hose GP40
- Mounting plate in wall housing SK 749 with flow monitor

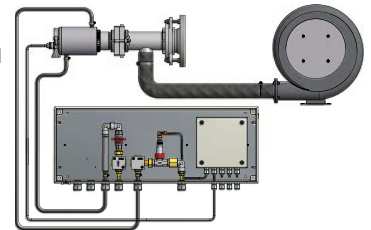

Mounting of the fibre optics version PA 21-001 for furnace installation

consisting of:

- Quartz window PS 01/I AF 2
- Bayonet coupling PS 11/N AF 5
- Air purge PS 01/A AF 1
- Shim Ø 35 mm
- Flange PS 01/N

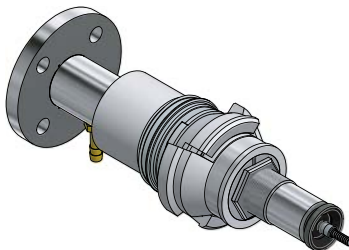

Mounting PA 20-004 with oscillating mirror for pedestal mount

consisting of:

- Cable VK 01/X
- Oscillating mirror PZ 20/X AF 6
- Intermediate tube PZ 20/J
- Clamping collar PZ 20/L AF 2
- Cable VK 01/Y AF 3
- Pedestal mount PB 08/K AF 2



Networking and communication via the USB interface

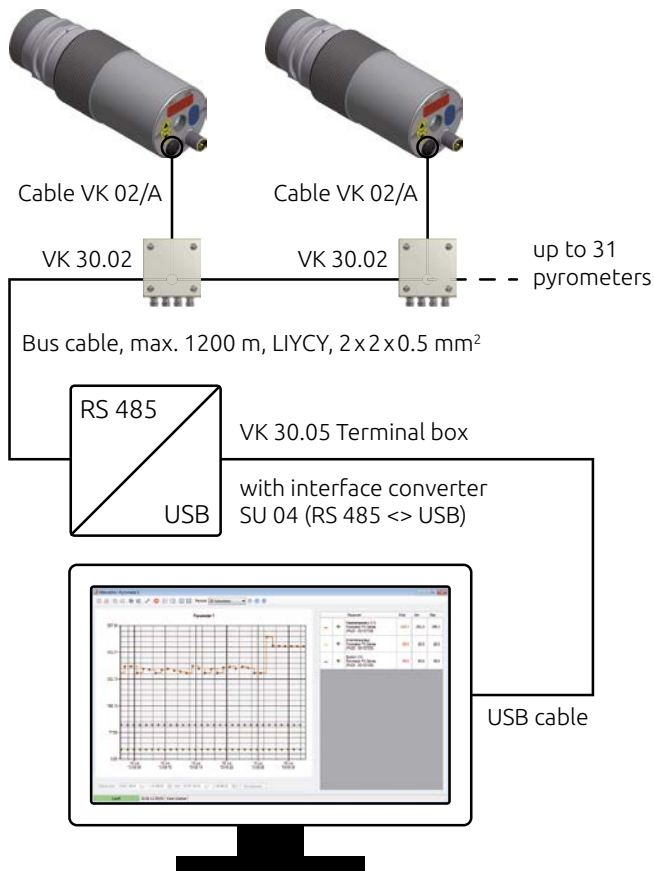

Networking and communication via Ethernet interface

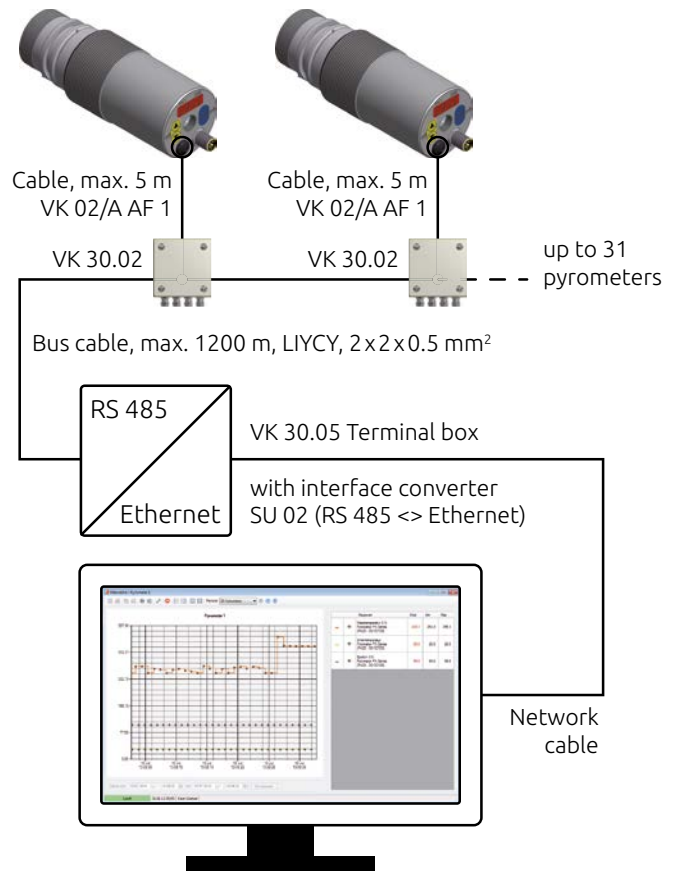

Networking, communication and video transmission via Ethernet

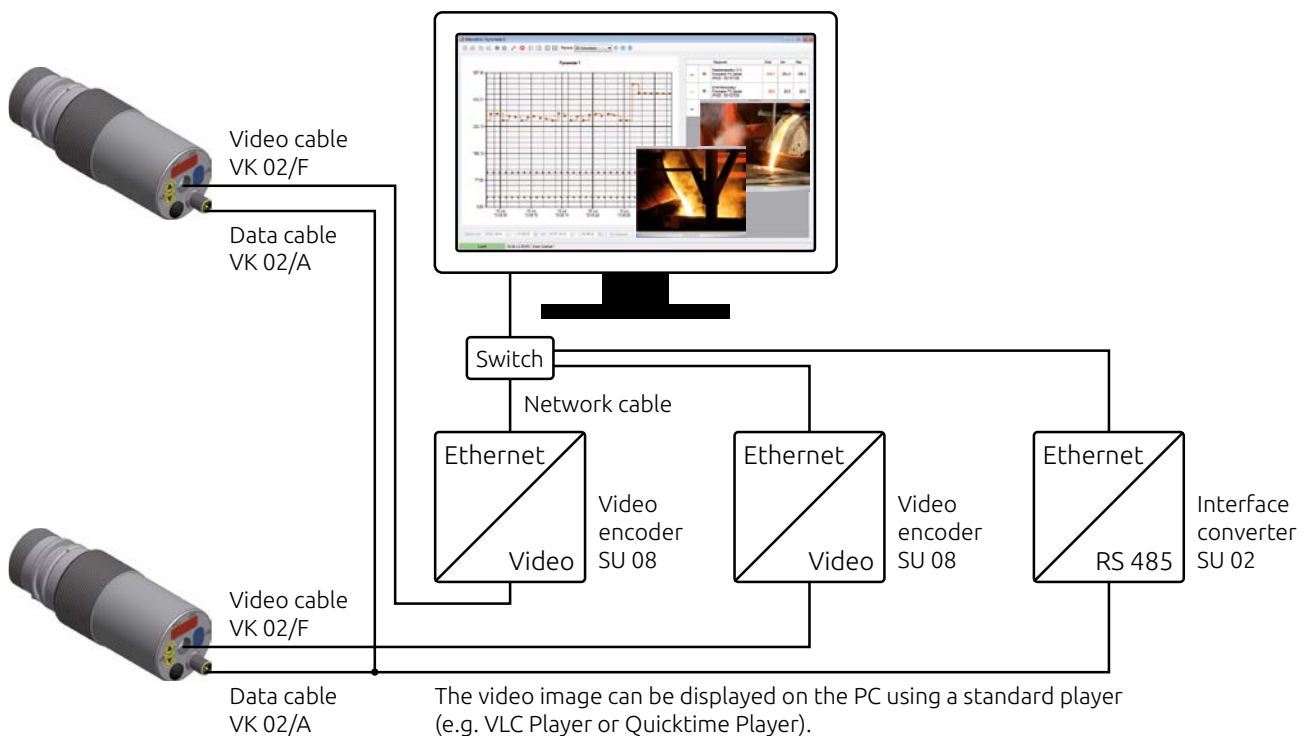

Special Accessories

Oscillating mirror PZ 20/X

An oscillating mirror with scanner function can be mounted to a CellaTemp® PA pyrometer. The measurement field is deflected to capture the target object. Use the analogue output in conjunction with a RS-422 interface to collect temperature readings together with target position.

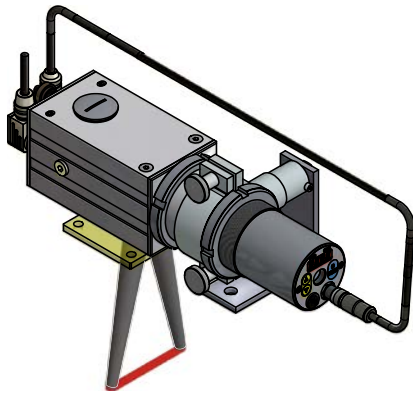

With the PZ/20 X you can:

- Detect „hot spots“ at belt conveyors
- Capture swaying wires
- Generate temperature profiles of sheet metals and steel slabs
- Measure the temperature of objects at a roller table whose size and position are not constant

The PZ 20/X accessory is supplied with CellaScan software to generate graphic images showing temperature data plotted against the scan angle.

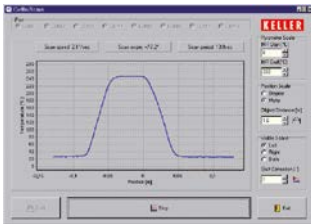

Illumination ring PZ 10/P

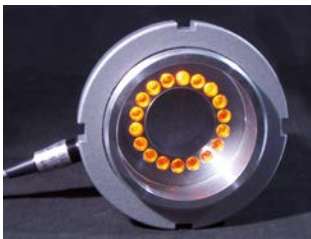

In dark furnaces, it is often impossible to see the target. Installing an auxiliary light source in a second porthole can be quite difficult and costly. Thus, in actual practice, pyrometers are often focused at the target only at the time of installation. Verification of correct focusing during running operations will not be possible.

The PZ 10/P illuminates the target spot in a closed furnace, utilizing the same furnace opening in which the pyrometer is installed. This built-in accessory is part of the pyrometer's mounting assembly.

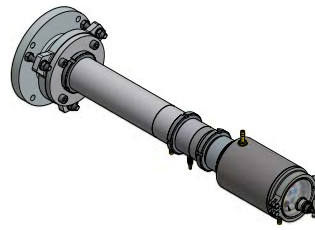

The illumination ring helps you align and focus the pyrometer to the measurement spot at the time of initial setup. What's more, this accessory lets you view the target area anytime later, such as during routine spot checks, and make adjustments if necessary.

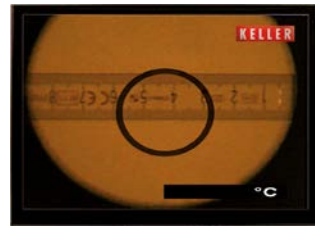

When used in conjunction with a pyrometer featuring a built-in video camera, you can view a live image of the illuminated target at a control room monitor.

Display unit DA 230

- Input: 0(4)–20 mA / 0(2)–10 V
Thermocouples type K, S, J, T
PT 100
- Analogue output: 0(4)–20 mA
- User-configurable ranges
- Panel mounting: 48 x 96 mm
- Supply voltage:
115–230 V/50–60 Hz
- Source voltage: 24 V DC
- RS-485 interface
- Data communication in ASCII format
- CellaMevis software for online imaging and archiving of temperature data



Interface converter/Video encoder



Interface converter SU 04
RS 485 <-> USB

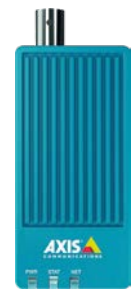

Video encoder SU 08
Video <-> Ethernet



Interface converter SU 02
RS 485 <-> Ethernet

Applications



Asphalt and concrete mixing

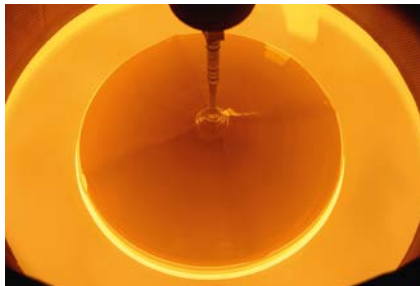

Crystal growing



Coke oven



Wires, tubes and rods



Filaments / Metal bands



Runner



Incineration plant



Rolling mill



Blast furnace / stove dome



Power plant



Continuous casting



Rotary kiln

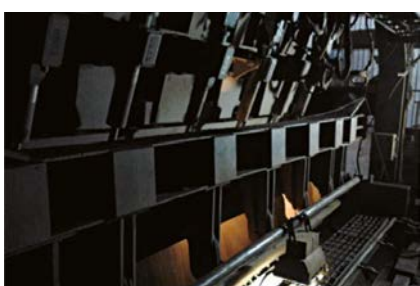

Sinter plant



Glass production



Induction heating

Other products



CellaPort PT

Portable single-colour and two-colour pyrometers with through-the-lens sighting, laser spot light and USB interface.



CellaCast PT

Portable pyrometer for non-contact temperature measurement of molten metal at automated casting machines and blast furnaces.



CellaTemp® PK(L)

Compact infrared thermometer for cramped environments. Optional with LED spot light.



CellaTemp® PKF

Compact infrared thermometer with optical fibre and optical sensor head.



CellaTemp® PZ

Profibus pyrometers with focusable lens, through the lens sighting or laser spotlight.



CellaTemp® PZ-LWL

Pyrometer with Profibus interface, fibre optics, focusable measuring heads and laser spot light.



Mikro PV

Intensity comparison pyrometer for ultra accurate measurement.



CellaSwitch

Compact infrared switch with LED display and auto-diagnostics.

Since 1967, the Division Infrared Thermometer Solutions (ITS) of KELLER HCW GmbH develops and manufactures precision instruments and systems solutions for non-contact temperature measurements. Thanks to the continuous development of its range, KELLER ITS now is one of the leading providers for infrared thermometers and pyrometers worldwide.

With its very large product range of more than 250 models and systems KELLER ITS offers solutions for all standard applications and a variety of special measuring tasks.

Following the KELLER philosophy, the key focus in the development and production of the devices is set to the high measuring accuracy and reliability. Therefore, KELLER grants a warranty of 5 years on its products.

A global network of distributors and service points ensures competent and personal consultation on site.

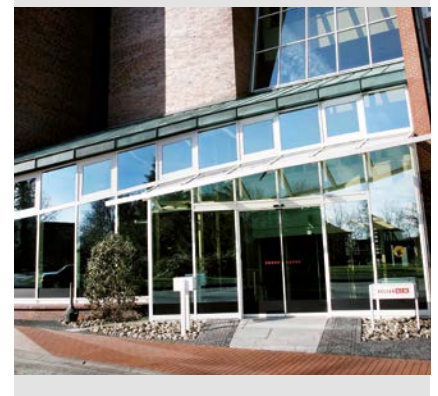

KELLER

Creating Solutions

infrared
temperature
solutions

ITS



- Headquarters
- Sales and Service Center
- Sales abroad



Keller HCW GmbH
Infrared Temperature Solutions (ITS)
Carl-Keller-Straße 2-10
49479 Ibbenbüren-Laggenbeck
Germany

www.keller.de/its
Tel. +49 (0) 5451 850
Fax +49 (0) 5451 85412
its@keller.de

Sales and Service Center

France
www.keller.de/its
Tel. +33 (0) 951 453050
its@keller.de

Italy
www.giga-tech.it
Tel. +39 (0) 296489130
contatti@giga-tech.it

Spain
www.umi.es
Tel. +34 94 446 62 50
comercial@umi.es

China
www.keller-its.cn
Tel. +86 (0) 10 828 679-20
keller@germantech.com.cn

India
www.keller-itsindia.com
Tel. +91 (0) 98841 11025
info@keller-itsindia.com

Korea
www.ultratec.co.kr
Tel. +82 (0) 70 8282 5979
ellen@ultratec.co.kr

